

Tuning Process of Single Input Fuzzy Logic Controller Based on Linear Control Surface Approximation Method for Depth Control of Underwater Remotely Operated Vehicle

¹M.S.M. Aras, ²S.S. Abdullah, ¹H.I. Jaafar, ²M.A.A. Aziz and ¹A.M. Kassim

¹Faculty of Electrical Engineering, Universitiy Teknikal Malaysia Melaka,
 Hang Tuah Jaya, 76100 Durian Tunggal, Melaka, Malaysia

²Department of Electric and Electronics,

Malaysia-Japan International Institute of Technology, Universitiy Teknologi Malaysia,
 International Campus Jalan Semarak, 54100 Kuala Lumpur, Malaysia

Abstract: This study investigates the linear approximation or piecewise linear approximation control surface method for tuning variable parameter of Single Input Fuzzy Logic Controller (SIFLC) for depth control of the underwater Remotely Operated Vehicle (ROV). This method will focus on slope of a linear equation to give optimum performances of depth control without overshoot in system response and faster rise time and settling time. The variable parameter for signed distance method in SIFLC tuning by Particle Swarm Optimization (PSO) algorithm. The optimum parameter will be obtained and approximately no more variable parameter can be tuned because the PSO algorithm will yield optimum parameter. This linear control surface approximation method represents an inference engine of fuzzy logic. The investigation also done based on slope of linear equation either in positive and negative values and come up from conventional FLC that will simplify into SIFLC. The results obtained the slope of linear equation will be affecting the results of system performances.

Key words: Single input fuzzy logic controller, linear control surface approximation, signed distance method, remotely operated vehicle, Malaysia

INTRODUCTION

This research inspired from the Conventional Fuzzy Logic Controller (CFLC), Multiple Inputs Single Output (MISO) system will be simplified into Single Input Single Output (SISO) system. Single Input FLC (SIFLC) based on the signed distance method and piecewise linear control surface method (Ishaque *et al.*, 2010). Figure 1 shows the structure of SIFLC based on the signed distance method proposed by Ishaque *et al.* (2010). The SIFLC in MATLAB Simulink as shown in Fig. 2. The 2 pink circles in Fig. 2 shows the variable parameter will be tuned by Particle Swarm Optimization (PSO) algorithm. The studies of PSO can refer to Jaafar *et al.* (2012), Kennedy and Eberhart (1995). For CFLC, the correlation between the input and output also known, as the input and output mapping is normally represented by a three-dimensional plot, known as a control surface (ψ). The control surface is useful for visual assessment and adjustment of the three-dimensional matrix rules and also known as the graphical representation of the combination affects the

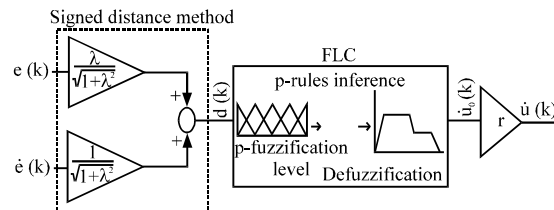

Fig. 1: Single input FLC structure

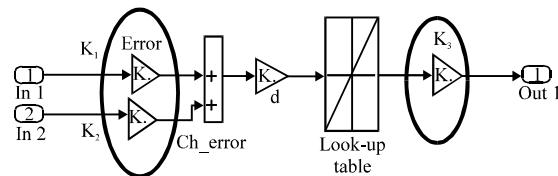

Fig. 2: Simplified single input FLC in Simulink

FLC variables, such as the membership functions, overlapping percentage, fuzzification, inference engine methods and defuzzification operator selections. Previous researchers (Bin Mohd Aras *et al.*, 2011; Feng, 2006) have

shown that the control property of an FLC is highly dependent on the shape of its control surface. The FLC behaves as a linear controller if control surface ψ reveals a linear surface (Ishaque *et al.*, 2010) as depicted in Fig. 3. As a result, the controller is also known as a Linear Fuzzy Logic Controller (LFLC). On the other hand, non-linear FLC may come in various control surfaces ψ shape as shown in Fig. 4a, b. Figure 4 is the examples of non-linear control surface. The membership functions, overlapping percentage, fuzzification, inference engine methods and defuzzification operator is a variables in general are recognized as tuning parameters. Different settings of tuning parameters yields different control surfaces which results in different control actions by the FLC (Farinwata *et al.*, 2000). Clearly, the optimum tuning of these parameters is the most decisive issues faced by the designers.

Table 1: Rule table for the example

d	L_L	L_S	L_Z	L_S	L_L
$u\Delta$	N_L	N_S	Z	P_S	P_L

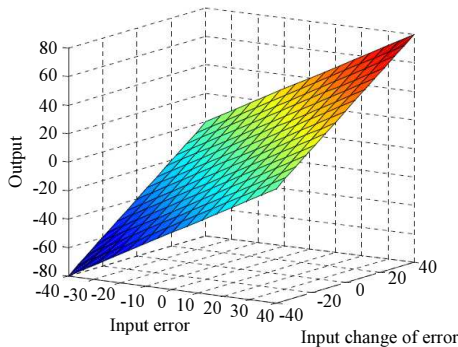
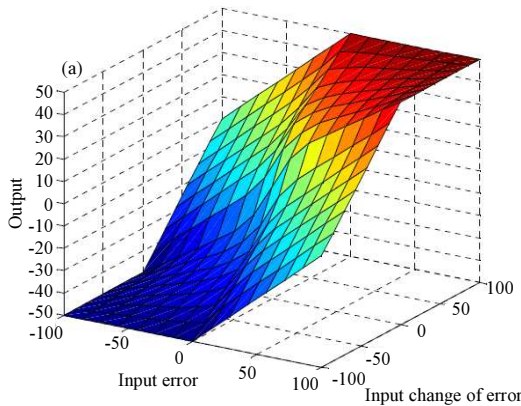

Fig. 3: Linear control surface of conventional FLC



For SIFLC, the control surface can be easily reduced to two-dimensional plot that means change into the SISO control surface. This is a natural by a product of the Signed Distance Method (SDM) which has reduced the rules to a one-dimensional array as derived from Table 1 and piecewise linear approximation method. Therefore, it is possible to produce an effective control surface for SIFLC without having to look into complex computations coupled with fuzzification, rules inferences and defuzzification processes. The main benefit of the signed distance method is the considerable reduction in the number of rules which in turn minimizes the computation required and execution time. In fact, it is possible for non-linear control surface to be approximated based on piecewise linear. However before the piecewise linear interpolation is employed, one has to ensure that the process will not dispossess SIFLC from the nonlinear properties of the conventional FLC that have made it a robust controller. The linear equation simpler to implement in real time system.

PIECEWISE LINEAR CONTROL SURFACE FOR SIFLC

In this study, the construction of piecewise linear control surface for SIFLC is described. The main research is to study and investigate the slope of the linear control surface. Before that the fundamental of piecewise linear control surface should be considered. Firstly, operating conditions for tuning parameters to approximate a linear surface are studied. Once, the optimum operating conditions are determined, the generalized output equation of linear surface is derived. From the output equation, it will be shown that the control surface shape is determined by the peak location of the input and output

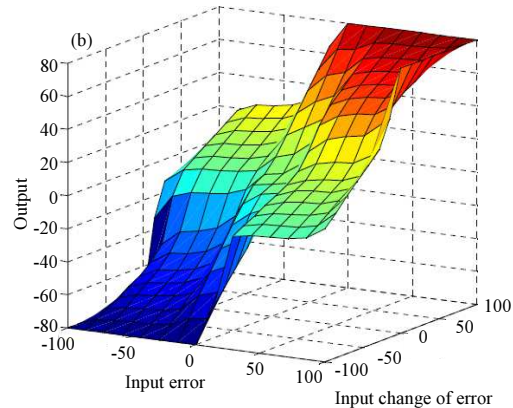

Fig. 4: Examples of non-linear control surface of conventional FLC: a) Control surface with low degree of non-linearity; b) Control surface with high degree of non-linearity

membership functions. Finally, examples of different piecewise linear control surface and its relationship to the original FLC control surface will be described. For the SIFLC control surface to be approximated to a piecewise linear, several operating conditions of the tuning parameters have to be met. These conditions are important if the SIFLC is to preserve the non-linearity capability of the fuzzy logic controller. They are recognized, such as membership function used for input and output sets, overlapping between membership function, inference engine and defuzzification method (Hasim *et al.*, 2012; Aras *et al.*, 2009). The effect of each of these parameters on the shape of the control surface can be qualitatively determined by trying different combinations of input and output membership functions under specific fuzzification, inference and defuzzification operators. This method of analysis has been proposed by Jantzen (1999). The fuzzy toolbox from MATLAB/Simulink used, the resulting control surface of the controller when subjected to different parameter conditions can be readily obtained (Azis *et al.*, 2012). First, the rules required by the signed distance method as stated in Table 1. Recalling that d is the distance input and $u\Delta$ is the output of SIFLC, the 5 rules are:

- Rule 1: If d is L_L then $u\Delta$ is N_L
- Rule 2: If d is L_S then $u\Delta$ is N_S
- Rule 3: If d is L_Z then $u\Delta$ is Z
- Rule 4: If d is L_P then $u\Delta$ is P_S
- Rule 5: If d is L_L then $u\Delta$ is P_L

For the rules inferences process, dot product operator is chosen for AND operation. For OR operation, the MAX operator is used. As for defuzzification process, the Centre of Gravity (CoG) method is widely used due to its simplicity. These selections are arbitrary and it should be noted that different selections of inference and defuzzification operators give up somewhat different results. As Ishaque *et al.* (2010), five different input and output configurations are evaluated. The researcher concluded that to obtain a linear control surface, the triangles and singleton sets are to be used for input output membership functions, respectively. In addition the overlapping between the input adjacent sets must be spaced at 50%.

DERIVATION OF OUTPUT EQUATION

Once the operating conditions to obtain the linear control surface are determined, the output equation can

be derived. The aim is to find the relationship between the output equation of the surface and the peak location of input and output membership functions (Hasim *et al.*, 2012). To derive the output equation, consider the input and output memberships, the triangular and singleton sets are to be used, respectively. The overlapping between the input adjacent sets must be spaced at 50%. If L_{-2} , L_{-1} , L_0 , L_1 and L_2 are the input membership functions and S_{-2} , S_{-1} , S_0 , S_1 and S_2 are the output singleton membership functions, its rules inference can be written as:

- Rule 2: If d is L_{-2} then \dot{u}_0 is S_2
- Rule 3: If d is L_{-1} then \dot{u}_0 is S_1
- Rule 4: If d is L_0 then \dot{u}_0 is S_0
- Rule 5: If d is L_1 then \dot{u}_0 is S_1
- Rule 6: If d is L_2 then \dot{u}_0 is S_2

The rules can be tabulated as shown in Table 2. Slope of zero diagonal line λ is equal to 1, as both membership functions for input in Table 2 are same. The matrix rules used in Ishaque *et al.* (2010) are 7×7 and will be simplified into single input as shown in Table 3. The seven input rules will be simplified to five input rules. Based on derivation from (Jaafar *et al.*, 2012) the look-up (Table 4) using Eq. 1 can be computed. By using Eq. 1, five input values for corresponding seven diagonal lines in Table 5 are calculated:

$$d = \frac{w + Ze\lambda}{\sqrt{1 + \lambda^2}} \quad (1)$$

Table 2: The proposed reduced rule table using the signed distance method

d	L_{NL}	L_{NS}	L_Z	L_{PS}	L_{PL}
\dot{u}_0	N_L	N_S	Z	P_S	P_L

Table 3: The SISO rule table proposed by Ishaque *et al.* (2010)

	L_{NL}	L_{NM}	L_{NS}	L_Z	L_{PS}	L_{PM}	L_{PL}
d	(-0.7)	(-0.466)	(-0.233)	(0)	(0.233)	(0.466)	(0.7)
\dot{u}_0	N_L	N_M	N_S	Z	P_S	P_M	P_L
	-0.99	-0.66	-0.33	0	0.33	0.66	0.99

Table 4: The proposed reduced SISO rule table

d	$L_{NL}(-0.7)$	$L_{NS}(-0.353)$	$L_Z(0)$	$L_{PS}(0.353)$	$L_{PL}(0.7)$
\dot{u}_0	N_L	N_S	Z	P_S	P_L
	-0.99	-0.5	0	0.5	0.99

Table 5: Look up table parameter

Row	d	\dot{u}_0
1	-0.700	-1.00
2	-0.700	-0.99
3	-0.353	-0.50
4	0.000	0.00
5	0.353	0.50
6	0.700	0.99
7	0.700	1.00

Table 6: The other proposed SISO rule table

d	L_{NL} (-0.566)	L_{NS} (-0.283)	L_Z (0)	L_{PS} (0.283)	L_{PL} (0.566)
\dot{u}_o	N_L -1	N_S -0.5	Z 0	P_S 0.5	P_L 1

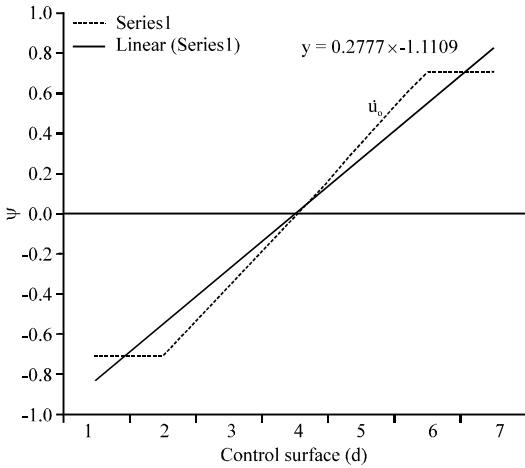

Fig. 5: Plotted graph using look-up table for a control surface

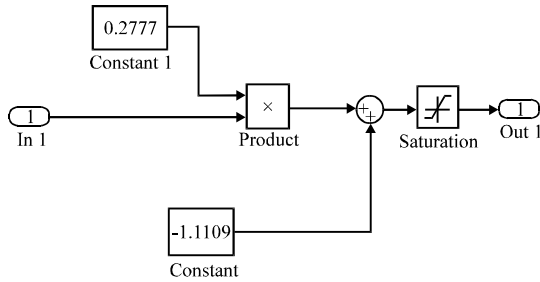

Fig. 6: Linear equation in MATLAB Simulink

- For diagonal line L_Z , $d = 0$
- For diagonal line L_{NS} , $d = -0.353$
- For diagonal line L_{NL} , $d = -0.7$
- For diagonal line L_{PL} , $d = 0.353$
- For diagonal line L_{PS} , $d = 0.7$

The derived SISO table is given in Table 6 and 3. Based on look-up table in Fig. 5, another method for piecewise linear approximation using a linear equation. The linear equation based on look-up table parameter and also can obtain from experiment for open loop test for depth. The results almost the same. The linear equation simpler to implement in real time application. In MATLAB Simulink, the linear equation can be represented as shown in Fig. 6. The MATLAB Simulink based on plotting linear line in control surface.

Figure 7 shows the example of positives and negatives linear equations. The difference between linear

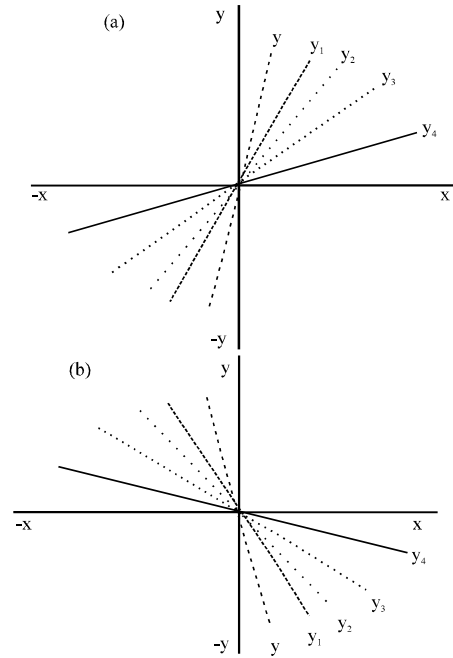

Fig. 7: Example of: a) Positives linear equation; b) Negative linear equation

equation is the slope of linear line. In this study, the slope of linear line also covered where several experiments conducted to ensure the effect of slope in the system.

RESULTS AND DISCUSSION

Figure 8 shows single input fuzzy logic controller for depth control of underwater remotely operated vehicle. The details of design and specification can refer Azis *et al.* (2012) and Aras *et al.* (2012, 2013). This study more on tuning process of SIFLC to give better performances. The linear control surface approximation method will be used. Figure 9 shows the system response of the ROV system.

Figure 10 shows several experiments conducted with different slope of linear equations. The negative slope totally cannot be used. The signal output does not follow the set point. The best slope of linear equations for this system is 0.5 where gives the system performances better than others. If the slope bigger, the system response not good, chattering occurs. For depth control, chattering even overshoot must be eliminated. As depth control, clearly overshoot in the system response can damage to both to the ROV and to inspections environment, such as in cluttered environments. Figure 11 shows the best system response based on slope of linear equations are 0.5.

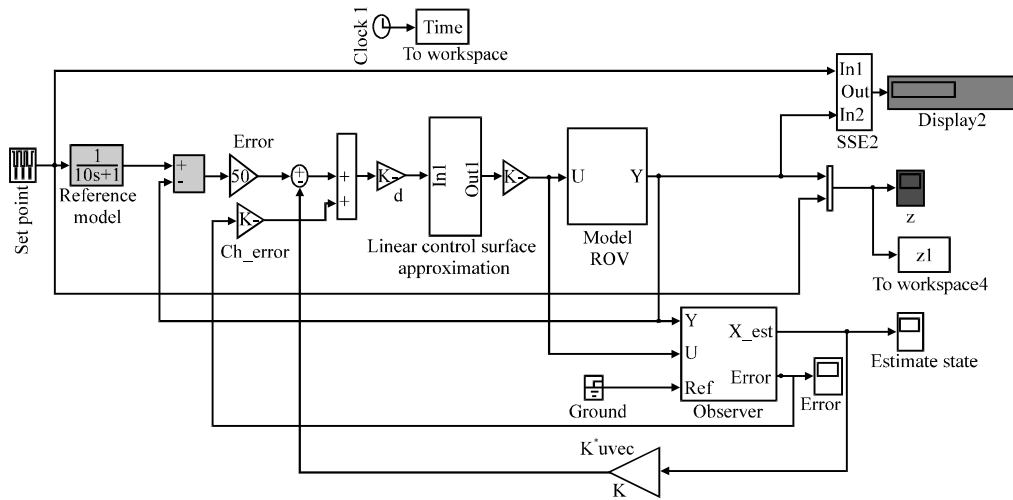

Fig. 8: Single input fuzzy logic controller for depth control of underwater remotely operated vehicle

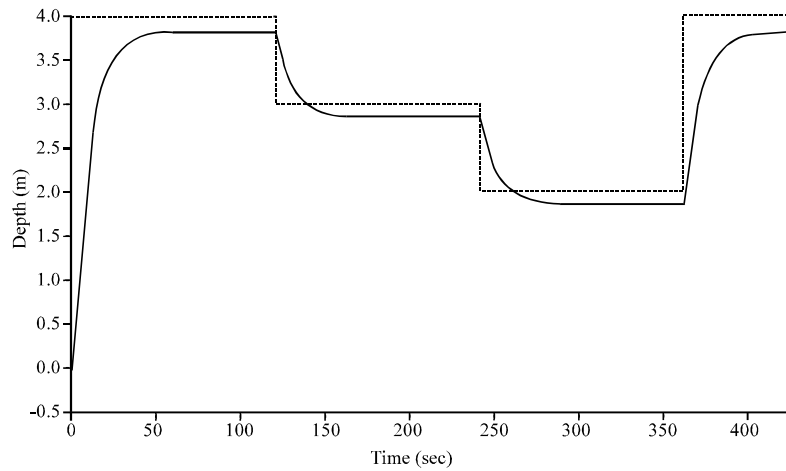

Fig. 9: The system response of ROV system based on linear equation

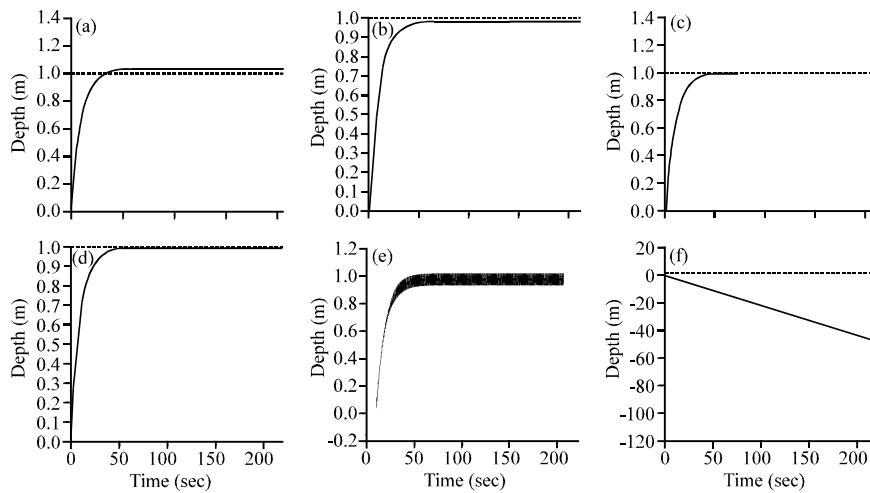

Fig. 10: The different slope of linear equation tested: a) Slope = 0.2; b) Slope = 0.4; c) Slope = 0.5; d) Slope = 0.6; e) Slope = 0.8; f) Slope = -0.2

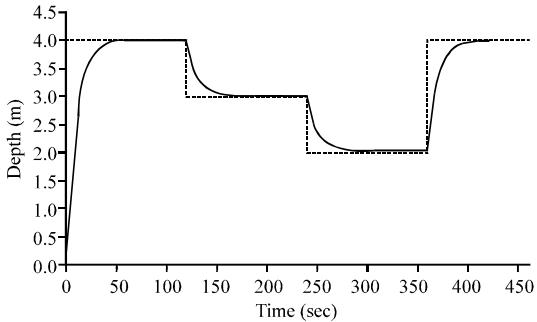

Fig. 11: The system response of ROV system

CONCLUSION

According the results, the control surface to be approximated as a linear or piecewise linear for tuning variable parameter of Single Input Fuzzy Logic Controller (SIFLC) for depth control of the underwater Remotely Operated Vehicle (ROV) are successfully done. This method will focus on slope of a linear equation to give optimum performances of depth control without overshoot in system response and faster rise time and settling time.

The best slope of linear equations for this system is 0.5 where gives the system performances better than others. If the slope bigger, the system response not good, chattering occurs. For depth control, chattering even overshoot must be eliminated.

A faster calculation is expected as fuzzification, rules inferences and defuzzification processes are eliminated to become SIFLC. Operating conditions for the tuning parameters to produce a linear control surface are determined and output equation of the linear surface is derived. It has been shown that the output is a function of peak location of input and output membership functions. By changing the peak location, different control surfaces of piecewise linear regions can affect the performances of depth control for the ROV.

ACKNOWLEDGEMENTS

Special appreciation and gratitude to the honorable University (Universiti Teknikal Malaysia Melaka, UTEM and Universiti Teknologi Malaysia, UTM), especially to the both Faculties of Electrical Engineering for providing the financial, as well as moral support to complete this project successfully.

REFERENCES

- Aras, M.S.M., S.N.B.S. Salim, E.C.S. Hoo, I.A.B.W.A. Razak and M.H.B. Hairi, 2009. Comparison of Fuzzy control rules using MATLAB toolbox and simulink for DC induction motor-speed control. Proceedings of the International Conference of Soft Computing and Pattern Recognition, December 4-7, 2009, Malacca, Malaysia, pp: 711-715.
- Aras, M.S.M., F.B.A. Azis, S.M.S.B.S. Hamid, F.A.B. Ali and S.S.B. Abdullah, 2011. Study of the effect in the output membership function when tuning a fuzzy logic controller. Proceedings of the International Conference on Control System, Computing and Engineering, November 1-6, 2011, Penang, pp: 1-6.
- Aras, M.S.M., F.A. Azis, M.N. Othman and S.S. Abdullah, 2012. A low cost 4 DOF remotely operated underwater vehicle integrated with IMU and pressure sensor. Proceedings of the 4th International Conference on Underwater System Technology: Theory and Applications, December 4-6, 2012, Shah Alam, Malaysia, pp: 180-23.
- Aras, M.S.M., S.S. Abdullah, A.A. Rahman and M.A. Abd Aziz, 2013. Thruster modelling for underwater vehicle using system identification method. *Int. J. Adv. Rob. Syst.*, 10: 1-12.
- Azis, F.A., M.S.M. Aras, M.Z.A. Rashid, M.N. Othman and S.S. Abdullah, 2012. Problem identification for underwater Remotely Operated Vehicle (ROV): A case study. *Procedia Eng.*, 41: 554-560.
- Farinwata, S.S., D.P. Filev and R. Langari, 2000. *Fuzzy Control: Synthesis and Analysis*. John Wiley and Sons, Baffins Lane, Chichester.
- Feng, G., 2006. A survey on analysis and design of model-based fuzzy control systems. *IEEE Trans. Fuzzy Syst.*, 14: 676-697.
- Hasim, N., M.Z.A. Rashid, M.S.M. Aras, A.M. Kassim and S. Shah, 2012. Development of fuzzy logic water bath temperature controller using MATLAB. Proceedings of the IEEE International Conference on Control System, Computing and Engineering, November 23-25, 2012, Penang, Malaysia, pp: 11-16.
- Ishaque, K., S.S. Abdullah, S.M. Ayob and Z. Salam, 2010. Single input fuzzy logic controller for unmanned underwater vehicle. *J. Intell. Robot Syst.*, 59: 87-100.
- Jaafar, H.I., Z. Mohamed, A.F.Z. Abidin and Z.A. Ghani, 2012. PSO-tuned PID controller for a nonlinear gantry crane system. Proceedings of the IEEE International Conference on Control System, Computing and Engineering, November 23-25, 2012, Penang, pp: 515-519.

- Jantzen, J., 1999. Design of fuzzy controllers. Technical Report No. 98-E-864, Department of Automation, Technical University of Denmark.
- Kennedy, J. and R. Eberhart, 1995. Particle swarm optimization. Proceedings of the International Conference on Neural Networks, Volume 4, November 27-December 1, 1995, Perth, WA., USA., pp: 1942-1948.