

The Performance of CDMA System with Novel Concatenated FEC Schemes in AWGN Channel

A.R. Abdul Rajak
 College of Engineering Vellore Dt, Tamil Nadu, India

Abstract: CDMA has become the focus of current research interests to provide higher data rates for end users and to accommodate more users over wireless channels in the next generation communication systems having 3G standard and 4G standard. Two important features of CDMA systems are the use of complex spreading and user dedicated pilot channel. This CDMA system uses QPSK since it is one of m-ary keying systems intended for bandwidth reductions. The performance this system gets is affected by many factors in the channel. This can be done by efficient FEC scheme. This study proposes a novel FEC scheme, which reduces BER and hence improves the performance of the CDMA system

Key words: Novel concatenated, scheme, performance, research

INTRODUCTION

CDMA transmitter model: In the communication link of CDMA^[1] systems, where an I/Q^[2] code-multiplexed pilot is utilized, spreading consists of two operations. The first is channelization operation, in which pilot and data symbols on I- and Q-branches are independently multiplied with an orthogonal variable spreading factor code and transformed into a number of chips. The second operation is scrambling, where the resultant signal is further multiplied by a complex valued scrambling code. This spreading scheme is called complex spreading, as illustrated in Fig. 1.

The transmitted signal of the *k*-th user can be written as (1)

$$S_j(t) = \sqrt{E_{D,j}} \sum_{n=-\infty}^{\infty} \left\{ \begin{aligned} & \left[\sqrt{g_j} C_{P,j}(n) S_j(n) - D_j(m) C_{D,j}(n) S_Q(n) \right] \\ & \cdot h(t - nT_c) \cos(\omega_0 t + \phi_j) \\ & - \left[\sqrt{g_j} C_{P,j}(n) S_Q(n) - D_j(m) C_{D,j}(n) S_I(n) \right] \\ & \cdot h(t - nT_c) \sin(\omega_0 t + \phi_j) \end{aligned} \right\} \quad (1)$$

Where

$E_{D,j}$ is chip energy of data channel, g_j is power ratio of pilot channel to the data channel, $D_j(m)$ is data symbols for the *j*-th user, m is integer part of n/P_N , P_N is spreading factor, ϕ_j is carrier phase, $C_{P,j}(n)$ and $C_{D,j}(n)$ are orthogonal channel codes for pilot and data symbols, respectively, $S_I(n)$ and $S_Q(n)$ are real and imaginary parts of the

cell-specific scrambling sequence, respectively, T_c is the chip interval and $h(t)$ is impulse response of the pulse shaping filter truncated by the length of AT_c for practical systems, where $A > 1$.

The power of the transmitted signal is expressed as

$$P_j = (1 + g_j) E_{D,j} / T_c = E_j / T_c \quad (2)$$

The channel model: The complex low-pass equivalent impulse response of a multi-path fading^[3,4] channel can be written as

$$h_j(t) = \sum_{l=0}^{L-1} \alpha_{j,l}(t) \delta[t - \tau_{j,l}(t)] e^{i\theta_{j,l}(t)} \quad (3)$$

Where L ($L \geq 1$) is the number of resolvable propagation paths. For the sake of simple notation, it is assumed that all users have the same number of multipaths. $\alpha_{j,l}(t) e^{i\theta_{j,l}(t)}$ and $\tau_{j,l}(t)$ are the complex fading factor and propagation delay of the *l*-th path of the *j*-th user, respectively. Note that $\alpha_{j,l}(t)$ can be Rayleigh, Rician or Nakagami distributed, depending on a specific channel model. All random variables in (3) are assumed independent for *j* and *l*. Assuming that there are *J* active users in the system, the received signal is given by

$$r(t) = \sum_{j=1}^J \sum_{l=0}^{L-1} \alpha_{j,l}(t) S_j [t - \tau_{j,l}(t)] e^{i\theta_{j,l}(t)} + \eta(t) \quad (4)$$

Where $\eta(t)$ is the AWGN with double-side power spectrum density $\eta_0/2$.

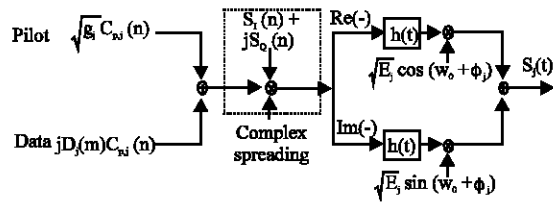

Fig. 1: The CDMA transmitter model for k-users

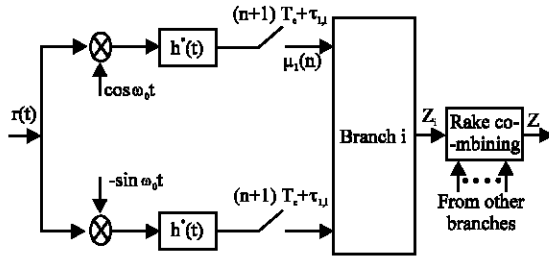

Fig. 2: RAKE structure of receiver

The receiver model: In order to mitigate multi-path effect, a RAKE receiver with pilot symbol aided coherent demodulation and Maximum Ratio Combining (MRC) is employed. The RAKE receiver structure is shown in Fig. 2, where the number of branches is less or equal to the number of resolvable paths. The received signal is multiplied by local carriers and passed through the pulse-matching filters and then sampled once per chip duration. The samples are fed to each branch of the RAKE receiver, where the pilot and data symbols are separately demodulated and pilot symbols are used to eliminate the phase error of different path and achieve MRC. Assuming that the *i*-th path delay τ_{i} can be accurately estimated for the reference user ($j = 1$), each path that corresponds to a RAKE branch gives an output component. The outputs of all branches are added together to form the decision statistic.

THE NEED AND THE OBJECTIVE OF THE RESEARCH

The performance of this system gets affected by the channel, which adds random noise, co channel interferences and adjacent channel interferences given by other active user. To improve CDMA network performance, it is required to implement FEC in this system. The FEC to be implemented should be efficient and to give better performance. This research study concentrates on to the improvement of performance of the existing system by employing the novel concatenated scheme, which is dealt in the following study.

IMPLEMENTATION OF A NOVEL FEC BY CONCATENATION OF REED SOLOMON CODE AND IRREGULAR TURBO CODE

This study deals with the novel FEC coding scheme used for CDMA wireless communication network. Here concatenated FEC codes are considered for Implementation. This concatenated code^[5] has outer code and inner code. In this proposed scheme Reed Solomon (RS)^[6] code is used as outer code, Irregular Turbo code^[7,8] is used as inner code. The reason for choosing RS code for implementation is that it gives better performance in burst noise environment and Irregular Turbo code is considered for its implementation that this is the latest code developed and exhibits best performance when compared to all other codes. The Fig. 3 shows the CDMA system with a novel FEC scheme by concatenation of RS code and Irregular code.

DESIGN STEPS FOR THE IMPLEMENTATION OF A NOVEL CONCATENATED FEC ON CDMA SYSTEM

- A sequence of random input bits is generated.
- The input data is converted into symbols of the Galois field GF (2⁵).
- These symbols should be divided into frames and are given to the Reed-Solomon coder (Outer Coder).
- Each block of symbols is encoded using RS encoding process.
- RS coded symbols of field GF (2⁵) are converted back into bits.
- These bits are divided into blocks and then fed to Irregular Turbo coder (Inner Coder).
- These bits are then encoded by irregular Turbo coding method.
- These encoded bits are spread for CDMA implementation by Pseudo Noise sequence by XOR operation.
- The spread bits are modulated in QPSK modulation and transmitted over noisy channel like AWGN channel. These channels add noise components with its input signal. From this noisy channel, the signal is given to the receiver section.
- The received bits containing errors from the channel are demodulated in QPSK demodulator.
- The demodulated noisy bits are fed to irregular decoder inner decoder, which involves iterative decoding. The decoding operation should be repeated for specific number of iterations for BER of 10⁻⁶.

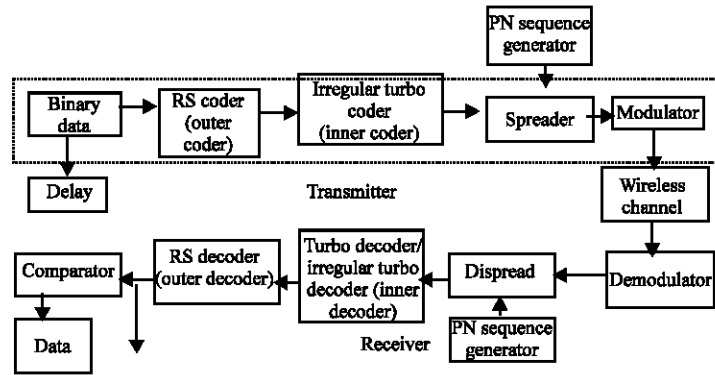

Fig. 3: CDMA system with a novel concatenated FEC by RS and irregular turbo codes

- The signal now is dispread by the same PN sequence employed at the transmitter.
- These bits are divided into blocks and are converted back to symbols of GF (2^5). Then these symbols are fed to RS decoder.
- RS decoder decodes the symbols and then again output symbols are converted back to bits and these bits are given to comparator.
- Then comparator will compare decoded bits with original bits to compute bit error rate.

The delay in the Fig. 3 is kept because there will be some delay for encoding and decoding.

Implementation results: This study shows the simulation model of the Turbo code^[9,10], proposed concatenated Turbo with RS code, irregular code and concatenated Turbo with RS code. Simulation models are implemented using the software package MATLAB 6.1. The results of the simulation are displayed using graphs in which the BER are plotted against SNR in decibels. The channels considered for simulation of all model is AWGN. The data frame sizes are chosen to be 460 information bits, which is close to the GSM standard (456 bits) and Wireless ATM (448). The modulation used for all simulations is QPSK. For calculating BER, frames are repeated 100 times. Most of the simulations are carried out for Turbo codes formed by combining components codes ($g_1=1\ 1\ 1_2=7_8$, $g_2=1\ 0\ 1_2=5_8$) each having a memory length of two. Frame sizes of 128 is taken for comparing interleaves of small size and frame size of 256 and 128 are considered for analyzing effect of frame size on Turbo codes. The interleaver used in this system is golden^[11] interleaver. The Turbo is concatenated with RS code^[12] to vary its implementation. The performance of CDMA with concatenated irregular Turbo with RS is simulated for its studies.

SPECIFICATIONS CONSIDERED FOR IMPLEMENTATION BY SIMULATION

The input data to all programs is given frame by frame. The type of input data is binary bits. The parameters of various error-correcting codes used are as Table 1-3.

Table 1: Parameters of Turbo Code in CDMA

Turbo code parameters	Specifications
Data frame size	460
Number of frame repetitions	1000
Generator polynomial type	RSC
Feed back generator polynomial	$[1\ 1\ 1]_2$ or 7_8
Feed forward generator polynomial	$[1\ 0\ 1]_2$ or 5_8
Interleave type	Golden
Interleave size	460
Rate	Unpunctured (1/3)
Decoding algorithm	Log-MAP
Number of decoding iterations	3 for BER 10^{-6}

Table 2: Parameters of RS code in CDMA

RS code parameters	Specifications
Field used	GF (2^5)
Message length (k)	31
Encoded length (n)	23
Encoded length (n)	23
Error correcting capability (t)	4 symbols
Generator polynomial (g)	$[5\ 30\ 9\ 1\ 19\ 23\ 22\ 3\ 0]$
Encoding type	Systematic
No of iteration	3
Name of iterative algorithm	Belekemp's Iterative algorithm
Error magnitudes computation	Fomey algorithm
Roots finding in GF	Chen's search algorithm

Table 3: Parameters of Irregular Turbo code in CDMA

Irregular Turbo code parameters	Specifications
Generator polynomial type	RSC
Feed back generator polynomial	$[1\ 1\ 1]_2$ or 7_8
Feed forward generator polynomial	$[1\ 0\ 1]_2$ or 5_8
Irregularity type	Pseudo-random
Irregularity percentage	10 %
Interleave type	Golden
Interleave size	460
Decoding algorithm	Log-MAP
Decoding iterations	3

Table 4: Comparison of BER Performance of CDMA systems with Novel Concatenated FEC scheme in AWGN channel

S. No.	Code	BER at SNR=5dB	BER at SNR=10dB	BER at SNR=15dB
1.	RS	10×10^{-2}	25×10^{-3}	6×10^{-3}
2.	Irregular turbo (10%)	7×10^{-2}	15×10^{-3}	3.5×10^{-3}
3.	RS and turbo	4×10^{-2}	8.5×10^{-3}	2×10^{-3}
4.	RS and irregular turbo (5%)	3.5×10^{-2}	7×10^{-3}	1.8×10^{-3}
5.	RS and irregular turbo (10%)	2.5×10^{-2}	6×10^{-3}	1.4×10^{-3}
6.	RS and irregular turbo (15%)	2×10^{-2}	4.5×10^{-3}	1×10^{-3}

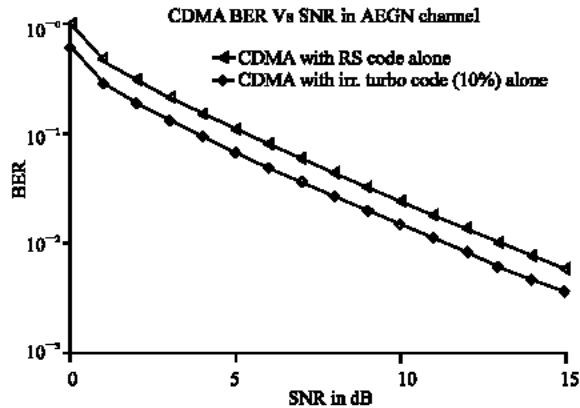

Fig. 4: BER performance of CDMA with RS code and irregular turbo code in AWGN channel

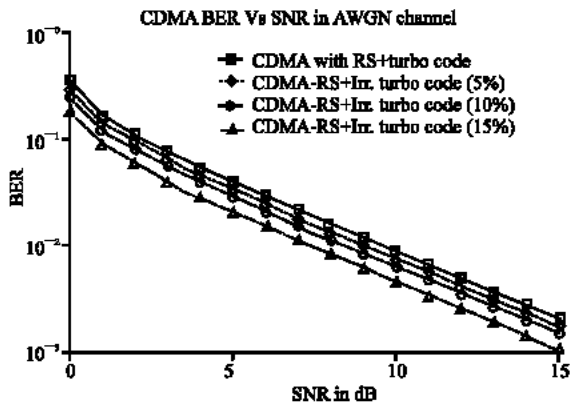

Fig. 5: BER performance of CDMA with proposed concatenated RS and irregular turbo code in AWGN channel

Simulation results: The BER performance of CDMA systems with individual RS code and individual irregular Turbo code in AWGN channel are shown in Fig. 4. BERs are studied with respect to SNR ranging from 0 dB to 15 dB in AWGN and from 0 dB to 15 dB in this channel.

It is observed that BER at SNR=5dB by RS code alone and irregular Turbo code alone in AWGN are 1×10^{-1} and 7×10^{-2} respectively and the same value is tabulated in Table 4 and Fig. 6. The BER performance of CDMA with the proposed concatenated FEC scheme is as shown

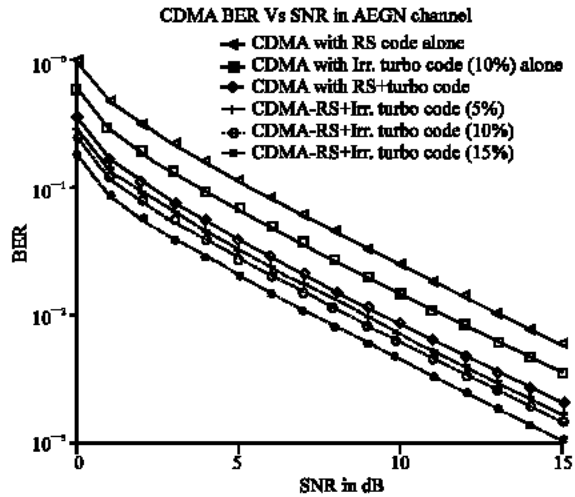

Fig. 6: Comparison of BER performance of CDMA systems with novel concatenated FEC scheme in AWGN channel

in Fig. 5. It is found that at 5 dB SNR BER is 4×10^{-2} due concatenated RS and Turbo code and is 2×10^{-2} due to RS and Irregular Turbo code.

RESULTS AND DISCUSSION

To analyze the performance of the proposed code, an image file of size 64×64 shown in Fig. 7 is considered. The binary data of the same Image is transmitted and received

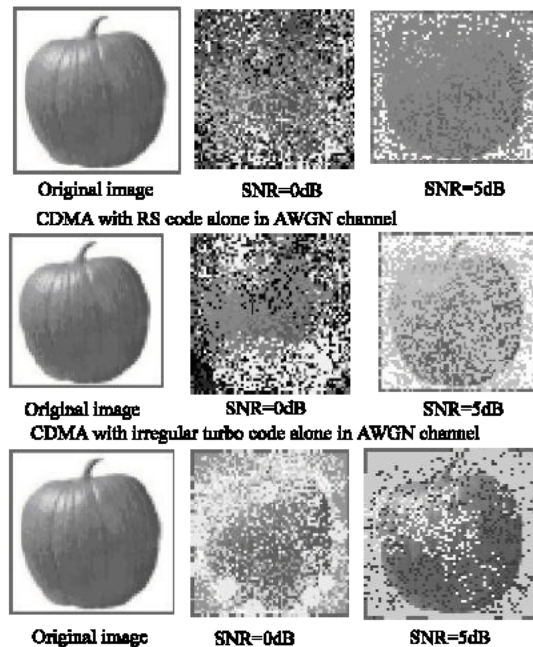

Fig. 7: CDMA with concatenated RS code and turbo code alone in AWGN channel

in CDMA system with RS code alone, Irregular Turbo code alone and the proposed FEC scheme through AWGN channel.

The research on CDMA wireless systems with concatenated Forward Error Correction schemes by i) RS code with Irregular Turbo code and ii) Turbo code with Irregular Turbo code is carried out and the same is simulated in MATLAB 6.1. The followings are some of the conclusions drawn from the study carried out:

- The simulation results on CDMA with concatenated FEC by RS code and Irregular turbo code give better performance than the CDMA system with RS Code alone, Irregular turbo code alone in AWGN channel.

REFERENCE

1. Friel, P., R. Vijayaraghavan and R. Annapillai, 1999. Comparison of convolutional coding with direct spreading, IS-95 CDMA System, pp: 344-354.
2. Lim, J., L.K. Rasmussen and H. Sugimoto, 2000. Relative performance of BPSK and QPSK in the presence of complex multi-user CDMA Interference, *Wireless Personal Communications* 13 (3): Kluwer Academic Publishers, pp: 237-256.
3. Zhang, Y. and S.L. Miller, 2003. Transmit diversity DS-SS systems. *IEEE Transactions on Communications*, pp: 1378-1388.
4. Paranchych, D.W. and N.C. Beaulieu, 2000. Performance of a digital symbol synchronizer in Co channel interference and noise, *IEEE Transactions on Communications*, pp: 1945-1954.
5. Brutel, C. and J. Boutros, 1999. Serial concatenation of interleaved concatenated code and M-ary phase modulations, *Annales des Telecommunications*, pp: 111-117.
6. Shahzad, S., S. Yaqub and F. Suleman, 1993. Self-correcting codes conquer noise part2: Reed-Solomon Codes.
7. Christian Schlegel and Lance Perez, 1999. On error Bounds and Turbo-Codes, *IEEE Communications Letters*, pp: 205-208.
8. Frey, B.J. and D.J.C. Mackay, 1999. Irregular Turbo Codes, in *Proceedings of the 37th Allerton conference on Communication, Control and computing Allerton House, Illinois*, pp: 99-106.
9. Shin, H. and J.H. Lee, 2003. Improved upper bound on the bit error probability of turbo codes for ML decoding with imperfect CSI in a rayleigh fading channel, *Research Publication, School of Electrical Engineering, Seoul National University*, pp:122-132.
10. Barbulescu, S.A., J.A. Torres and V. Demjanenko, 2003. Turbo Codes, *ITU-Telecommunication Standardization Sector Temporary Document CF-036*, pp: 355-364.
11. Shanmugam and A.R. Abdul Rajak, 2003. Optimal interleave for turbo codes in wireless networks, *National conference on Emerging Trends in VLSI design and testing, PSG College of Tech.*, pp: 157-165.
12. Ferrari, M., F. Osnato, M. Siti, S. Valle and S. Bellini, 2001. Performance of Concatenated Reed-Solomon and Turbo Codes with non Ideal Interleaving, *Proceedings of Globecom'01, IIT Mumbai*, pp: 976-1001.