

## Spread Spectrum Techniques for Powerline Communication

C.D. Suriyakala and P.E. Sakaranarayanan  
Sathyabama Institute of Science and Technology,  
Deemed University Old Mamallapuram Road, Chennai-600 119

**Abstract:** The communication flow is very high today. Many applications are operating at high speed and a fixed connection is preferred. If the powerline utilities could supply communication over the powerline to the customers it could make a tremendous break through in communications as it is cost effective compared to other systems because it uses an existing infrastructure. Every household would be connected at any time and real time services could be provided. An energy meter is basically a watt-hour and it registers continuously the quantity of electrical energy that is being used by the consumer from time to time. Normally this instrument, in our country, is an electromechanical device with mechanical counters and still being profusely used. The counter reading shows the consumed energy. To find out the monthly energy consumption of clients, the Electricity department in our country has to periodically send human agents to retrieve readings of the meter from the client's residence or the industry. The human agents do not do this efficiently since the agent does not come on the appointed date and this may vary depending upon the convenience of the agent. With this in view, we are attempting some design changes to such a meter, sending the direct digital energy meter reading through the simulated powerline channel using spread spectrum techniques and analyze the bit error rate at the controlling authorities (Electricity Board).

**Key words:** BER, CDM, OFDM, PC and IR LED

---

### INTRODUCTION

Power line communication has been the main focus of much study work since the liberalization of the telecommunication markets. With the growing interest in power line communications the scope of possible applications also increased. Although many applications are in vogue, we wanted to concentrate on communication data pertaining to energy consumption to the main electricity office for billing purpose. In this context, it may be mentioned that in our country there are two types of meters available-analog and digital. Conventional meters are analog in nature and these are still being used. The basic principle of such meters involves two coils-one the voltage coil and the other current coil to measure the corresponding quantities. The product of these two along with the power factor gives us the power consumed. The power is measured directly from a rotating disc, which drives a decade counter. Next comes the digital meter. The underlying principle is same, but the quantities here are digitized by appropriate circuitry and the power consumed is displayed in the LED/LCD display provided. The digital meter has the advantage of a digital read out. i.e., it can be

used as the input data for digital communication which the analog meter does not. At present both meters have an inherent disadvantage. They both require an individual/agent to physically come and take down the readings and report to house hold/office the amount one has to pay. The proposed technology being developed is an attempt to replace the need for an individual/agent to physically read the consumer data<sup>[1]</sup>. The meter directly has the ability to send the reading to the controlling authorities through power line.

In this study the following section describes the hardware set up used. For data transmission over any medium it is necessary to determine those characteristics of the channel, which are important from the communications point of view. So section three is concentrated in development of a channel model, describing the transfer and noise characteristics of in house power line channel. Section 4 deals with mode of transmission over the simulated power line channel. This section mainly deals with the studies on the utilization of the promising Code Division Multiplexing (CDM) and Orthogonal Frequency Division Multiplexing (OFDM) for the data communication over the selected channel model.

The results of the study so conducted, particularly in respect of Bit Error Rate (BER) performance and spectral efficiency. The final section concludes with a summary and an outlook on future work.

### HARDWARE SETUP USED FOR ENERGY METERING

In our study Energy meter reading mainly involves the microcontroller. The power consumed by the user is calculated by the rotation of the disc in the basic energy meters. A set up of IR sensor with the help of a switching transistor senses the dark band of the disc of the analog energy meter. The output signal of the switching transistor is fed to the microcontroller as an interrupt. The microcontroller is programmed in such a way that meter reading is continuously monitored. The meter reading is stored in the EEPROM chip so that the data will not be erased during power failure. The EEPROM is used as a backup. Max 232 is used to interface the micro-controller with a computer. MAX232 is used for serial port communication with the personal computer. The meter readings are continuously up dated in the computer<sup>[2]</sup>. The data (energy consumed) is transmitted through simulated power line channel (echo model is used) using the spread spectrum technique.

The Fig. 1 shows the hardware set up used in our study to get the digital reading, which is interfaced with PC (Personal Computer).

The circuit designed here can be used for metering single and three-phase power supplies the core is the microcontroller operating at speed of 11/12 MHZ. its speed is sufficient to count the pulses without any miss. It performs the process of counting the pulses and outputs the stored value whenever enable pulse is send to it. The micro controller will count the meter readings and store it in an EPROM. These meter readings can also be displayed on seven-segment display. The data (consumed power) is transmitted to the personal computer using a serial communicating device (MAX 232). These data are updated in the system continuously.

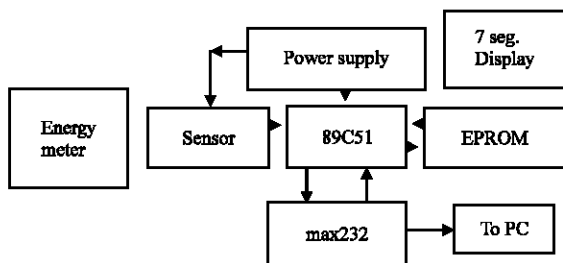

Fig. 1: Hardware set up used

### SIMULATION OF POWERLINE CHANNEL

The power line when used as a communication channel exhibits complex characteristics<sup>[3]</sup>. This necessitates identification of a suitable channel. While communicating data over the power line, the data travels through various paths and finally reach the destination. For modeling the power line channel, has to take into effect these multipath characteristics. The impulse response in such case will be

$$h(\tau) = \sum |\rho| \exp(j\phi) \cdot \delta(\tau - \tau_v) \quad (1)$$

Where each path is described by a delay  $\tau$ , an amplitude  $\rho$  and a phase  $\phi$ . The impulse response is the sum of delayed and weighted Dirac pulses. For each path 3 parameters has to be specified. For each path these three parameters (delay  $\tau$ , amplitude  $|\rho|$  and phase  $\phi$ ) have to be defined and this involves a large computational effort. To get over this difficulty, Philipps (ISPLC2000) have suggested a method with a good trade off between effort and result<sup>[4,5]</sup>. Alternative method is search for significant paths. The impulse responses, which are derived from the measured transfer function, are searched for local maxima. Maximum is significant only if amp is not below the threshold level and peak is more than a certain amount. After selecting a particular class/group of channel, the amp, delay and phase of each path has to be determined. In order to do this within each class mean value and standard deviation of the delay of each path are derived. The amplitude of the paths is normalized to the maximum amplitude of the channel. The scaling factor is the attenuation of the strongest path of the channel. For the normalized amplitude model channel the mean values and standard deviation are derived separately for each path. The resulting normalized impulse response is considered. The transfer function of modeled channel can be derived from the Fourier transform.

Figure 2 shows echo model of power line channel used<sup>[6,7]</sup>. It has also been found that in the development of the echo model, also called the statistical channel model, the transfer and noise characteristics of a typical in-house power line channel has been considered up to a range of 30MHZ (Holger Philips ISPLC2000).

Channel noise during the channel simulation- Noise spectrum comprises of disturbances by short wave radio signals, narrow band interference and background noises. The background noise is decreasing with increase in frequency. It can be described by an exponential function of first order. An example of a residential environment, which only consists of back ground noise and

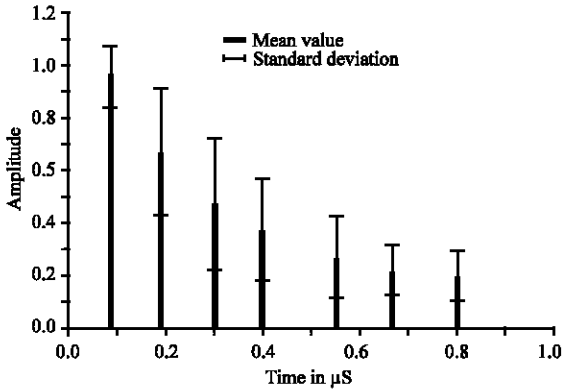

Fig. 2: Echo model of power line channel

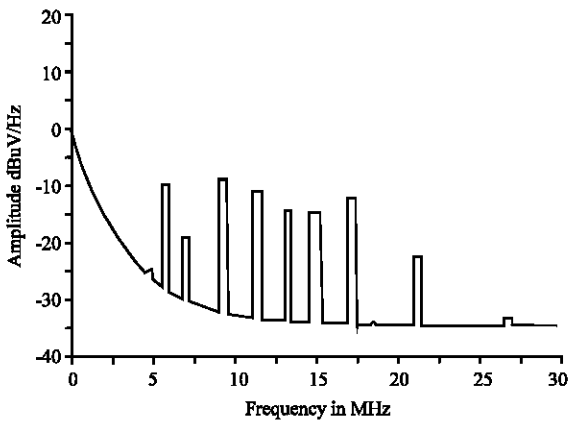

Fig. 3: Noise spectrum of the model

disturbances by SW radio signals. It can be seen that a disturbance is most noticeable in the frequency range between 5 MHz and 22 MHz Fig. 3.

The channel model is a combination of echo model and background noise. The background noise considered in the channel is given by  $N(f) = -35 + 35 \cdot \exp(f/3.6)$  (f in MHz) dBuV/Hz.

**MODE OF TRANSMISSION OVER THE SIMULATED CHANNEL**

Several multiplexing techniques for transmitting data using Power Line Communication (PLC) systems have been discussed in the literature<sup>[8,9]</sup>. The two well-known schemes considered here are CDM and OFDM. The choice of multiplexing scheme is dependent on the nature of the physical medium on which it has to operate.

**OFDM simulation SYSTEM:** Multicarrier modulation has long been known as an efficient modulation scheme for band limited channel. Orthogonal Frequency division

Table 1: Spectral efficiency of OFDM

No. of subcarriers	Spectral efficiency (bps Hz <sup>-1</sup> )
4	0.4
8	0.2
16	0.1
32	0.05
64	0.025
128	0.0125

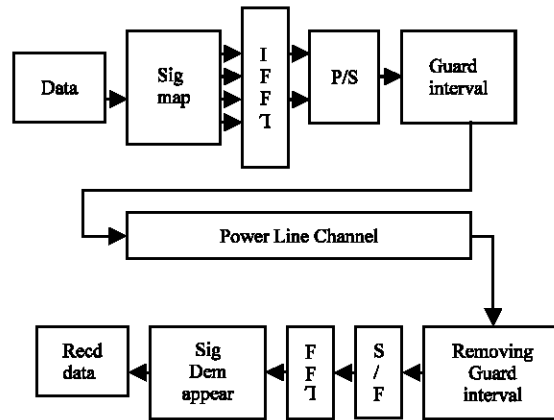

Fig. 4: OFDM System for simulation

Multiplexing is one of the most promising methods for power line communication<sup>[10,11]</sup>. Beside high bandwidth efficiency it offers several favorable aspects. The enlarged symbol duration leads to a decreased susceptibility to impulsive noise. The insertion of guard interval increases the immunity to delay spread because of multipath propagation.

A simplified version of simulation system is depicted in Fig. 4 the number of bits which are mapped to the symbols of the different subcarriers depends on the desired data rate and the quality of sub channels.

**Spectral efficiency and BER performance:** The bandwidth efficiency of any modulation technique is evaluated in terms of the spectral efficiency, that is the information in bps transmitted per Hz of channel bandwidth<sup>[12,13]</sup>.

The Table 1 results show that as the number of subcarrier is increasing the spectral efficiency decreases. The BER was then estimated by varying Signal-to-Noise Ratio (SNR) for different values of guard intervals as shown in Fig. 5. It is observed that the BER increases with increase in the guard interval. This is because the effective signal power gets reduced, as a large amount of transmitted power rests in the guard interval. Therefore the guard interval should be appropriately chosen so as to reduce ISI and at the same time use less transmitted power.

Table 2: Spectral efficiency of CDM

No. of walsh symbols	Spectral efficiency (bps Hz <sup>-1</sup> )
4	0.0417
8	0.0313
16	0.0208
32	0.0130
64	0.0078
128	0.0046

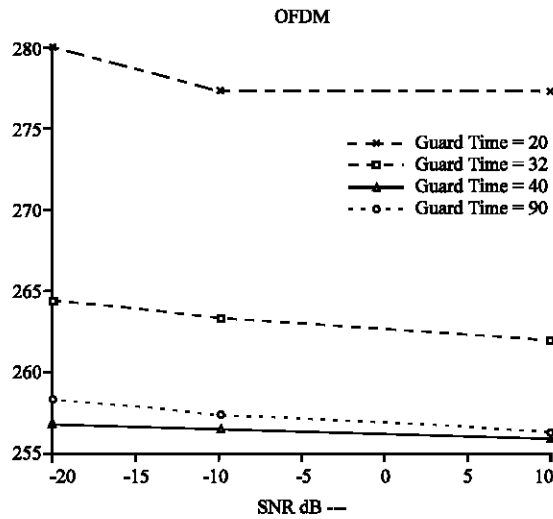

Fig. 5: BER vs. SNR for different guard interval in OFDM

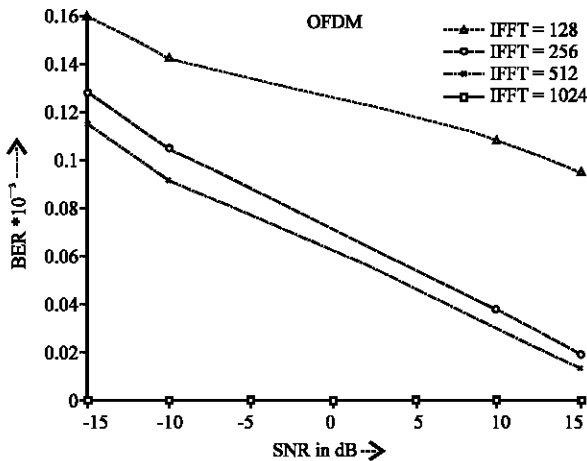

Fig. 6: BER vs. SNR for different IFFT size in OFDM

Next the BER variation with respect to the SNR for different number of subcarriers used, that is the size of IFFT / FFT block used in the system. The BER reduces as the number of subcarriers increase because the modulation scheme becomes more resilient to frequency selective fading of the powerline Fig. 6.

**CDMA Simulation system:** Spread spectrum system offer several advantageous aspects with regard to power line communications. Another aspect is the immunity to

narrow band interference. For coding purpose convolution encoding and Walsh coding is mainly used. Source is convolutionally encoded with a code rate of 1/3. The system is done according to CDMA IS-95 standard. A random binary generator generates the message for a simulation time of 0.02 s. The CRC bits and zero padding are assumed to be already added and the data is generated at a bit rate of 9600 bps. The data is split into several frames of 192 bits long (50 ms frames). These are encoded by a 1/3 rate convolutional encoder. Each group of six bits is replaced by a corresponding 64 bits long orthogonal Walsh code. This orthogonal spreading imparts excellent auto-correlative properties to the code, however the orthogonally spread code can be intercepted by any receiver. So it is further spread by a Long PN code, which has bit duration of 1/4 times that of the Walsh bit. The sequence appears truly random to an interceptor due to its long period.

The BER estimation is carried out by varying Signal-to-Noise Ratio (SNR) for different lengths of the Walsh code. It is observed that the BER is almost zero. It is also noted that the BER estimated when using CDM is significantly lesser than that observed for the OFDM technique. But the CDM technique is not a spectrally efficient scheme compared to the OFDM technique. So, to combine the advantages of the two techniques, the joint performance of these two techniques on a power line is analyzed.

**Spectral efficiency and BER performance:** Table 2 spectral efficiency is reduced as Number of Walsh symbols are increasing.

**Combined CDM / OFDM modulation:** The application of OFDM and CDM modulation methods for the power line in the previous chapters have shown that OFDM is a spectrally efficient scheme, but gives rise to high values of BER. CDM technique proves to offer less BER, but its spectral efficiency is very poor. So, to combine the advantages of the two techniques, a combined modulation is proposed Ref. Fig. 7. Shows combination of CDMA and OFDM.

**Spectral efficiency and BER performance:** The spectral efficiency of the combined CDM and OFDM modulation technique is analyzed in Table 3.

It is observed that from the Table 3 that, a proper choice of the OFDM and CDM parameters can give a spectral efficiency which is better than the CDM technique. Next the BER analysis is estimated by

Table 3 Spectral efficiencies of the combined modulation scheme

No. of walsh symbols	No. of subcarriers	Spectral efficiency (bps Hz <sup>-1</sup> )
4	4	0.016668
4	8	0.008334
4	16	0.004167
8	4	0.0125
8	8	0.00625
8	16	0.003125
16	4	0.008334
16	8	0.004167
16	16	0.00208
32	4	0.00520
32	8	0.00260
32	16	0.00130
64	4	0.00312
64	8	0.00156
64	16	0.00078
128	4	0.001824
128	8	0.000912
128	16	0.000456

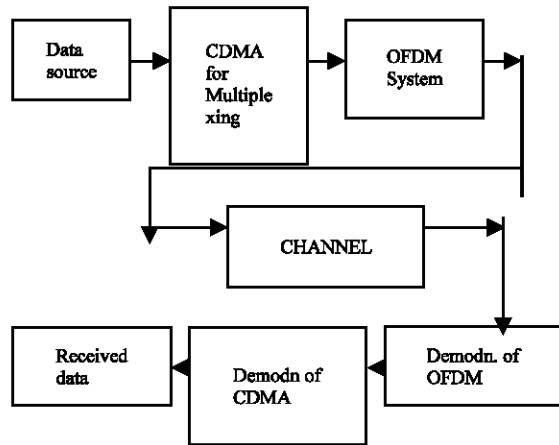

Fig. 7: Combination of CDMA and OFDM

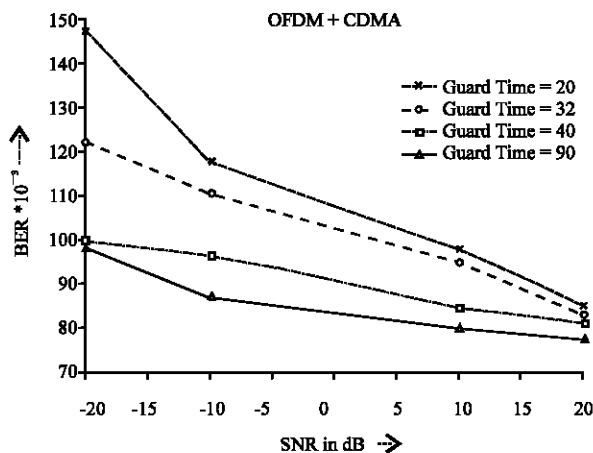

Fig. 8: BER vs. SNR for combined OFDM/CDM for different IFFT size

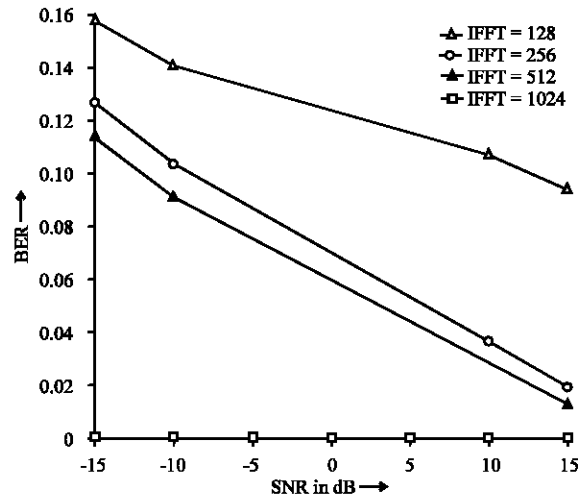

Fig. 9: BER Vs SNR for combined OFDM/CDM for different guard times

varying SNR for different value of guard intervals which is shown in Fig. 8.

Figure 9 shows the BER variation with respect to the SNR for different number of subcarriers used for the combined modulation scheme. It is been observed that there is tremendous improvement in BER as the no of sub carriers increase in this mode and is better by nearly two orders of magnitude compared to the OFDM scheme.

### CONCLUSION

The results of the comparative study made on the use of the three different cases, OFDM, CDMA and the combination of OFDM and CDMA techniques for power line communication. The bit error rate introduced during transmission, from the CDMA point of view is the best as BER in this case is almost zero. The next best has been found to be followed by the combination of OFDM and CDMA. Studies on the bit error rate vs. SNR for OFDM technique and hybrid scheme (OFDM and CDMA combined) for different guard time show that low BER can be obtained when guard time is 25% of IFFT size. Studies on the bit error rate vs. SNR for OFDM technique and hybrid scheme (OFDM and CDMA combined) for different IFFT size shows that low BER can be achieved when IFFT size increases. The system complexity is also reduced for the same value of spectral efficiency and the BER performance of the combined scheme is a compromise between the OFDM and the CDM schemes. This technique also paves the way for self monitoring of energy consumption by the consumers and automatic billing from the EB side.

**REFERENCES**

1. Sakaranarayanan, P.E. and Merlin, Accessing remote energy meter Second IEEE Electro information Technology conference (eit-2001) EIT 2001-155, Oakland university, Rochester, Michigan.
2. Sakaranarayanan, P.E. and C.D. Suriyakala, Intelligent energy meter proceedings 40th Annual National Convention of Computer Society of India, pp: 580-592.
3. Banwell, T.C. and S. Galli, 2001. A new approach to the modeling of the transfer function of the power line channel. International Symposium on Power line Communications and its Applications Proceedings.
4. Philipps, H., 1998. Performance Measurements of powerline channels at high frequencies. Proceeding Intl. Symposium on Powerline Communications, pp: 229-237.
5. Philipps, H., 1999. Modeling of powerline communication channel. Proceeding International Symposium on Powerline Communications, Berlin, pp: 14-21.
6. Philips, H., 2000. Development of a statistical model for powerline communication channels. International Symposium on Powerline Communications and its Applications Proceedings, pp: 153-160.
7. Prasad, T.V., S. Srikanth, C.N. Krishnan and Ramakrishnan, 2001. Wide band characterization of low voltage outdoor power line communication channel in India International Symposium on Powerline Communications and its Applications Proceedings.
8. Del, Re, Fantacci, Morosi Seravalle and Peiraccioli, 2000. Orthogonal Direct sequence CDMA for broadcast communications on power lines. International Symposium on Powerline Communications, pp: 60-66.
9. Ishikawa, N. and Gen Marubayashi, 2000. Studies on FH/MMFSK Powerline Transmission system. International Symposium on Powerline Communications and its Applications 2000, pp: 74-78.
10. Jurgan Haring and J. Han Vinck, 2000. OFDM Transmission corrupted by impulsive noise. International Symposium on Powerline Communications and its Applications, pp: 9-14.
11. Patrick, J. and Lang Field Dostert, 2000. OFDM system synchronization for power line communication. International Symposium on Powerline Communications and its Applications, pp: 14-19.
12. Proakis, J.G., 1995. Digital Communications 3rd Edn. Mc Graw-Hill.
13. Wolfgang Schulz and Sasha Schwarze, 2000. Comparison of CDMA and OFDM for data communication on medium Voltage Power grid. Intl. Symposium on Powerline Communications and its Applications, pp: 31-38.