

MRAS and Luenberger Observer Based Sensorless Indirect Vector Control of Induction Motors

M. Messaoudi, L. Sbita, M. Ben Hamed and H. Kraiem

Research Unit of Modeling, Analysis and Control of Systems (MACS),

National Engineering School of Gabes (ENIG), Tunisia

Abstract: In this study, Luenberger observer (LO) with a model reference adaptive system (MRAS) are associated for a sensorless vector control of an induction motor (IM). It is shown by an extensive study that this adaptive observer is completely satisfactory at low and nominal speed ranges and it is robust to load torque variations. The proposed control scheme achieves a good performance with computational complexity reduction obtained using analytical relation to determine the LO gain matrix. The effectiveness of the proposed scheme is checked via extensive simulation work. Simulation results prove that the proposed overall scheme provides both the rotor flux and rotor speed estimation with good transient and steady state performances.

Key words: Induction motor, field-oriented control, sensorless, Luenberger observer, MRAS

INTRODUCTION

In recent years significant advances have been made on the control of IM on the basis of rotor speed, flux and stator current measurements (Sbita and Ben Hamed, 2007a). The most commonly drive method is the field oriented control (FOC). It allows, by means a co-ordinate transformation, to separate the electromagnetic torque control from the rotor flux one and, hence to manage IM as a direct current (DC) motor. FOC method can be separated into two categories: Direct-field-orientated control (DFOC) includes a closed loop rotor-flux controller and requires an accurate knowledge of rotor-flux modulus and position. This is the standard solution for high performance drives but requires more complicated implementation techniques (Sbita and Ben Hamed, 2007b). The Indirect-field-orientated control (IFOC) does not have a closed-loop rotor-flux controller and only requires the angular position of the rotor-flux vector which is calculated integrating the angular speed (Messaoudi *et al.*, 2007a). This can be computed using the rotor speed and the stator-current measurement. IFOC is a very simple and, therefore worth to be considered solution in many applications.

The interest for sensorless drives of IMs has been constantly rising during the last years (Ben Hamed and Sbita, 2006). Tachogenerators or digital shaft-position encoders are usually used to detect the rotor speed of IM. Also, the IM fluxes can be arduously measured by hall sensors or sensing coils. These speed and flux sensors

caused many problems, such as degradation in mechanical robustness, increased cost, increased volume and lower the system reliability and require special attention to noise. In addition, for some special applications such as very high-speed motor drives and in hostile environment, there exist difficulties in mounting these sensors (Lee and Chen, 1998). Therefore, flux and rotor speed are usually estimated through stator current and voltage measurements.

In recent literature, many researches have been carried on the design of sensorless control schemes of the IM. Most methods are basically based on the Model Reference Adaptive System schemes (MRAS) (Schauder, 1992). In Kojabadi *et al.* (2005) the authors used a reactive-power-based-reference model derived in both motoring and generation modes but one of the disadvantages of this algorithm is its sensitivity to detuning in the stator and rotor inductances. Another method based on the Extended Kalman Filter (EKF) algorithm is used by Lee and Chen (1998) and Messaoudi *et al.* (2007a). The EKF is a stochastic state observer where nonlinear equations are linearized in every sampling period. An interesting feature of the EKF is its ability to estimate simultaneously the states and the parameters of a dynamic process. This is generally useful for both the control and the diagnosis of the process. In (Messaoudi *et al.*, 2007a) the authors used the EKF algorithm to simultaneously estimate variables and parameters of the IM in healthy case and under different faults. Lee and Blaabjerg (2006) used the Extended

Luenberger Observer for state estimation of IM. The Extended Luenberger Observer is a deterministic observer which also linearizes the equations in every sampling period. Another type of methods for state estimation which is based on the intelligent techniques is used in the recent years by many authors (Sbita and Ben Hamed, 2007; Simoes and Bose, 2001). Fuzzy logic and neural networks has been a subject of growing interest in recent years. Neural network and fuzzy logic algorithms are quite heavy for basic microprocessors. In addition, several papers provide sensorless control of IM which are based on the variable structure technique (Kim *et al.*, 2004) and the high gain observer which is a powerful observer that can estimate simultaneously variables and parameters of a large class of nonlinear systems and doesn't require a high performance processor for real time implementation (Besancon *et al.*, 2002; Messaoudi *et al.*, 2007b). Now, the IM becomes widely used in many industrial applications due to its reliability, ruggedness and relatively low cost. Thanks to the advances of power electronics and DSP technology, many control schemes of the IM are developed from simple scalar control methods to sensorless or auto-tuning control strategies, FOC and DTC.

In this study, we present the design of a high performance sensorless IM vector control scheme which is robust against load torque variations. The association of the LO with the MRAS based one, leads to a full order adaptive speed observer. This observer is designed to simultaneously estimate the rotor speed, the rotor fluxes and the stator currents. Simulation results are presented to highlight the effectiveness and the robustness of the proposed control scheme at nominal and at low speeds under variable load conditions.

INDUCTION MOTOR MODEL

The IM mathematical model established in a d-q coordinate system rotating at synchronous speed ω_s is given by the following equations:

$$\begin{bmatrix} \dot{i}_{sd} \\ \dot{i}_{sq} \\ \dot{\psi}_{rd} \\ \dot{\psi}_{rq} \\ \dot{\omega}_r \end{bmatrix} = \begin{bmatrix} -\gamma i_{sd} + \omega_s i_{sq} + \frac{\delta}{T_r} \psi_{rd} + \omega_r \delta \psi_{rq} + \frac{1}{\sigma L_s} v_{sd} \\ -\omega_s i_{sd} - \gamma i_{sq} - \omega_r \delta \psi_{rd} + \frac{\delta}{T_r} \psi_{rq} + \frac{1}{\sigma L_s} v_{sq} \\ \frac{L_m}{T_r} i_{sd} - \frac{1}{T_r} \psi_{rd} + (\omega_s - \omega_r) \psi_{rq} \\ \frac{L_m}{T_r} i_{sq} - (\omega_s - \omega_r) \psi_{rd} - \frac{1}{T_r} \psi_{rq} \\ \frac{p^2 L_m}{J_m L_r} (\psi_{rd} i_{sq} - \psi_{rq} i_{sd}) - \frac{B_m}{J_m} \omega_r - \frac{p}{J_m} T_l \end{bmatrix} \quad (1)$$

With:

$$T_r = \frac{L_r}{R_r}, \sigma = 1 - \frac{L_m^2}{L_s L_r}$$

$$\delta = \frac{L_m}{\sigma L_s L_r}, \gamma = \frac{R_s}{\sigma L_s} + \frac{R_r L_m^2}{\sigma L_s L_r^2}$$

where, L_r , L_s and L_m are the rotor, stator and mutual inductances, respectively, R_r and R_s are respectively rotor and stator resistances, σ is the scattering coefficient, J_m is the rotor inertia, B_m is the mechanical viscous damping, p is the pole pairs number and T_l is the external load torque.

ROTOR FLUX ORIENTATION STRATEGY

There are many categories of vector control strategy. We are interested in this study to the so-called IFOC. As shown in Eq. (1) that the expression of the electromagnetic torque in the dynamic regime presents a coupling between stator current and rotor flux.

The main objective of the vector control of induction motors is, as in a separately DC machines, to independently control the torque and the flux. This is done by using a d-q rotating reference frame synchronously with the rotor flux space vector. The d-axis is then aligned with the rotor flux space vector (Blaschke, 1972). Under this condition we get; $\psi_{rq} = 0$ and $\psi_{rd} = \psi_r$.

In this case the torque equation becomes:

$$T_e = p \frac{L_m}{L_r} \psi_r i_{sq} \quad (2)$$

It is right to adjust the flux while acting on the stator current component i_{sd} and to adjust the torque while acting on the i_{sq} component.

Using the forth and the fifth lines of Eq. (1):

$$i_{sd} = p \frac{(1 + T_r s)}{L_m} \psi_r^* \quad (3)$$

$$i_{sq} = \frac{T_r}{L_m} \omega_{sl}^* \psi_r^* \quad (4)$$

We replace i_{sq} by its expression to obtain T_e as function of the reference slip speed ω_{sl}^* .

$$T_e = p \frac{\psi_r^{*2}}{R_r} \omega_{sl}^* \quad (5)$$

Hence, the stator voltages commands are:

$$v_{sd}^* = (R_s + \sigma L_s s) i_{sd} + \frac{L_m}{L_r} s \Psi_r^* - \sigma L_s \omega_s i_{sq} \quad (6)$$

$$v_{sq}^* = (R_s + \sigma L_s s) i_{sq} + \sigma L_s \omega_s i_{sd} + \frac{L_m}{L_r} \omega_s \Psi_r^*$$

The rotor flux amplitude is obtained by solving Eq. (3) and its spatial position is given by:

$$\theta_s = \int \left(\omega_r + \frac{L_m i_{sq}}{T_r \Psi_r^*} \right) dt \quad (7)$$

ROTOR SPEED REGULATION

The use of a classical PI controller makes appear in the closed loop transfer function a zero, which can influence the transient of the speed. Therefore, it is more convenient to use the so-called IP controller which has some advantages as a tiny overshoot in its step tracking response, good regulation characteristics compared to the proportional plus integral (PI) controller and a zero steady-state error (Messaoudi *et al.*, 2007a). Figure 1 gives the structure of this type of regulator.

$$\frac{\omega_r(s)}{\omega_r^*(s)} = \frac{K_i K_p I_c p}{J_m s^2 + (B_m + K_p I_c p) s + K_i K_p I_c p} \quad (8)$$

Where,

$$I_c = \frac{T_e}{\omega_{sl}} = p \frac{\Psi_r^2}{R_r}$$

The gains of the IP controller, K_p and K_i , are determined using a design method to obtain a trajectory of speed similar to the response of a second order system

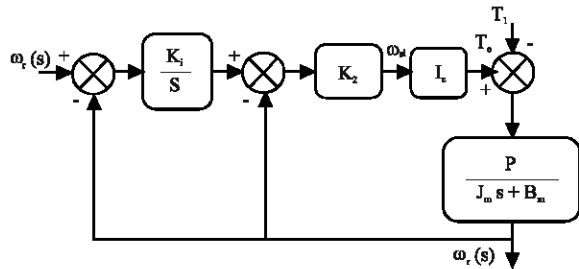

Fig. 1: Bloc diagram of IP speed controller in a drive system

with the desired parameters (ξ_d and ω_{nd}). The gains parameters values of the IP speed controller are easily obtained as:

$$K_p = \frac{(2\xi_d \omega_{nd} J_m - B_m) R_r}{p \Psi_r^2} \text{ and } K_i = \frac{J_m \omega_{nd}^2}{K_p p^2 \Psi_r^2} \quad (9)$$

ADAPTIVE LUENBERGER OBSERVER

The basic LO is a deterministic observer which can only be applied to state estimation of Linear-Time-Invariant systems (LTI) described by:

$$\begin{cases} \dot{\hat{x}}(t) = A \hat{x}(t) + B u(t) \\ y(t) = C \hat{x}(t) \end{cases} \quad (10)$$

The LO is then described by:

$$\begin{cases} \dot{\hat{x}}(t) = A \hat{x}(t) + B u(t) + L [y(t) - C \hat{x}(t)] \\ \hat{y}(t) = C \hat{x}(t) \end{cases} \quad (11)$$

where, $\hat{\cdot}$ denotes estimated values, $\hat{x}(t)$ the observer state vector and L is the observer gain matrix, which is selected so that the system will be stable.

If we consider the state estimation error:

$$\tilde{x}(t) = x(t) - \hat{x}(t) \quad (12)$$

Then

$$\dot{\tilde{x}}(t) = (A - LC) \tilde{x}(t)$$

The error dynamic is then given by Eq. (13) which is function of the initial condition:

$$\tilde{x}(0) = x(0) - \hat{x}(0)$$

$$\tilde{x}(t) = \exp[(A - LC)t] \tilde{x}(0) \quad (13)$$

Since, the induction motor is a nonlinear system, where its state matrix A is function of the rotor speed, L has to be adapted at each sampling time. Hence, it is important to note that the rotor speed is considered as a parameter of A . To avoid the use of an expensive speed sensor we opted to estimate this parameter using an adaptive observer based on the MRAS.

The state equation of the induction motor expressed in the stationary reference frame is given by the following form:

$$\begin{cases} \dot{x} = Ax + Bu \\ y = Cx \end{cases} \quad (14)$$

Where:

$$A = \begin{bmatrix} -\gamma I_2 & \delta(I_2 / T_r - \omega_r J) \\ (L_m / T_r) I_2 & -(I_2 / T_r - \omega_r J) \end{bmatrix}$$

$$B = \begin{bmatrix} (1/\sigma L_s) I_2 \\ 0_2 \end{bmatrix} \text{ and } C = [I_2 \ 0_2]$$

$$I_2 = \begin{bmatrix} 1 & 0 \\ 0 & 1 \end{bmatrix}, J = \begin{bmatrix} 0 & -1 \\ 1 & 0 \end{bmatrix}$$

$x = [i_{s\alpha} \ i_{s\beta} \ \psi_{r\alpha} \ \psi_{r\beta}]^T$ is the state vector, $u = [v_{s\alpha} \ v_{s\beta}]^T$ is the input vector and $y = [i_{s\alpha} \ i_{s\beta}]^T$ is the output vector.

DETERMINATION OF THE LUENBERGER GAIN MATRIX

To ensure that the estimation error vanishes with time for any $\tilde{x}(0)$, we should select the observer gain matrix L so that (A-LC) is asymptotically stable. Therefore, the observer gain matrix should be chosen so that all eigenvalues of (A-LC) have negative real parts.

To ensure stability (at all speeds), the conventional procedure is to select observer poles proportional to the motor poles (Vas, 1998) (the proportionality constant is k and $k = 1$). This makes the observer dynamically faster than the induction machine. However, to make the sensitivity to noise small, the proportionality constant is usually small. Thus by using this conventional pole-placement technique, the gain matrix is obtained as:

$$L = - \begin{bmatrix} l_1 I_2 + l_2 J \\ l_3 I_2 + l_4 J \end{bmatrix} = \begin{bmatrix} L_1 \\ L_2 \end{bmatrix} \quad (15)$$

- Determination of the eigenvalues of the matrix A.

$$\det(\lambda I_4 - A) = \begin{vmatrix} \lambda + \gamma I_2 & -\delta \left(\frac{1}{T_r} I_2 - \omega_r J \right) \\ -\frac{L_m}{T_r} I_2 & \lambda + \left(\frac{1}{T_r} I_2 - \omega_r J \right) \end{vmatrix} = 0 \quad (16)$$

To simplify the equation we posed:

$$a = \gamma I_2, \quad b = \frac{1}{T_r} I_2 - \omega_r J \text{ and } c = \frac{\delta L_m}{T_r}$$

The characteristic equation of the matrix A is then:

$$\lambda^2 + (a + b)\lambda + b(a - c) = 0 \quad (17)$$

- Determination of the eigenvalues of the matrix (A-LC).

$$\det(\lambda_o I_4 - (A - LC)) = \begin{vmatrix} \lambda_o + \gamma I_2 + L_1 & -\delta \left(\frac{1}{T_r} I_2 - \omega_r J \right) \\ -\frac{L_m}{T_r} I_2 + L_2 & \lambda_o + \left(\frac{1}{T_r} I_2 - \omega_r J \right) \end{vmatrix} = 0 \quad (18)$$

Hence the characteristic equation is:

$$\lambda_o^2 + (a + b + L_1)\lambda_o + (a - c)b + (L_1 + \delta L_2)b = 0 \quad (19)$$

The eigenvalues of the LO are proportional to the motor ones. This means that:

$$\lambda_o = k\lambda \quad (20)$$

Substituting Eq. (20) in (19) gives:

$$k^2 \lambda^2 + (a + b + L_1)k^2 \lambda + (a - c)b + (L_1 + \delta L_2)b = 0 \quad (21)$$

The identification of Eq. (21) and $k^2 \times (17)$ gives the following results:

$$\begin{cases} l_1 = -(k-1) \left(\gamma + \frac{1}{T_r} \right) \\ l_2 = (k-1) \hat{\omega}_r \\ l_3 = -\frac{(k^2-1)}{\delta} \left[\gamma - \frac{\delta L_m}{T_r} \right] + \frac{(k-1)}{\delta} \left(\gamma + \frac{1}{T_r} \right) \\ l_4 = -\frac{(k-1)}{\delta} \hat{\omega}_r \end{cases} \quad (22)$$

In Fig. 1 and 2, the trajectories of the motor poles and of the observer poles are illustrated for three different values of proportionality constant k. the speed range is from -157 to 157 rad sec⁻¹.

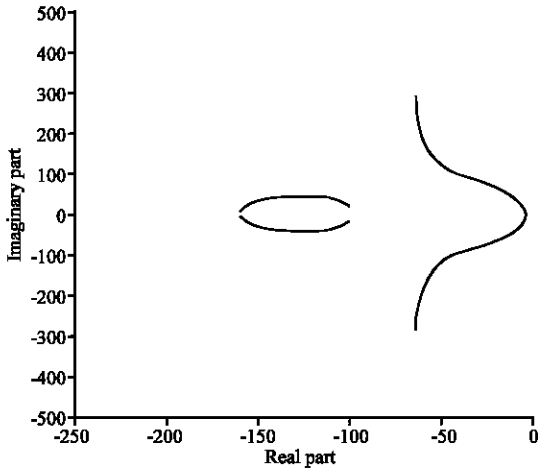

Fig. 2a: Trajectory of the motor poles for variable speeds

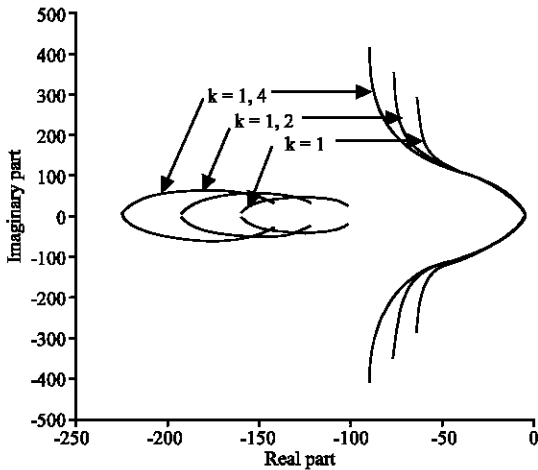

Fig. 2b: Trajectories of the observer poles for variable speeds and different values of k

MRAS-BASED ADAPTIVE SPEED ESTIMATION

It is possible to estimate the rotor speed by using two estimators (a reference-model-based estimator and an adaptive-model-based one), which independently estimate the rotor flux-linkage components in the stator reference frame. This method is called Model Reference Adaptive Systems (MRAS). The MRAS technique is used in sensorless IM drives, at the first time, by Schauder (1992). Since this, it has been a topic of many publications (Schauder, 1992; Kojabadi *et al.*, 2005; Sbita and Ben Hamed, 2007b). The MRAS is important since it leads to relatively easy to implement system with high speed of adaptation for a wide range of applications. The basic scheme of the parallel MRAS configuration is given in Fig. 3.

The scheme consists of two models; reference and adjustable ones and an adaptation mechanism. The

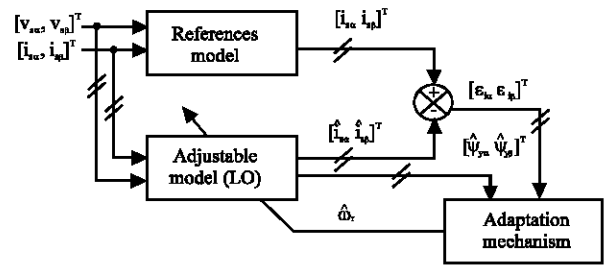

Fig. 3: MRAS-based speed estimator scheme

“reference model” represents the actual system having unknown parameter values. The “adjustable model” has the same structure of the reference one, but with adjustable parameters instead of the unknown ones. The appropriate adaptation mechanism can be derived up on Popov’s criterion of hyperstability. The “adaptation mechanism” consists of a PI-type of controller which estimates the unknown parameter using the error between the reference and the adjustable models and updates the adjustable model with the estimated parameter until satisfactory performance is achieved.

The IM speed observer equation is given by Eq. (23):

$$\hat{\omega}_r = K_p (\epsilon_{i_{\alpha s}} \hat{\psi}_{s\beta} - \epsilon_{i_{\beta s}} \hat{\psi}_{s\alpha}) + K_i \int (\epsilon_{i_{\alpha s}} \hat{\psi}_{s\beta} - \epsilon_{i_{\beta s}} \hat{\psi}_{s\alpha}) dt \tag{23}$$

If the chosen PI constants K_p and K_i are large, then the convergence of the rotor speed estimation will be fast. However, in a PWM inverter-fed induction machine, the estimated speed will be rich in higher harmonics, due to the PWM inverter. Thus the PI gains must be limited when the stator voltages and currents are obtained asynchronously with the PWM pattern (Vas, 1998).

Various open-loop speed and flux-linkage estimators have been discussed. These have utilized the stator and rotor voltage equations of the induction machine. However, the accuracy of these open-loop observers depends strongly on the machine parameters. In closed-loop estimators the accuracy can be increased.

RESULTS AND DISCUSSION

Simulations, using MATLAB Software Package, have been carried out to verify the effectiveness of the proposed control scheme. The application of the LO for unmeasured variables estimation is illustrated by a computer simulation shown in the block diagram of Fig. 4.

Figure 5 shows the behavior of the IM at nominal and zero speeds under variable load conditions. The reference speed is set to 157 rad sec⁻¹ at t = 1 sec. Then

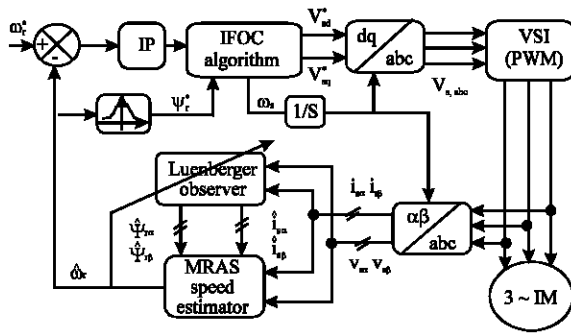

Fig. 4: Sensorless IFOC scheme of IM

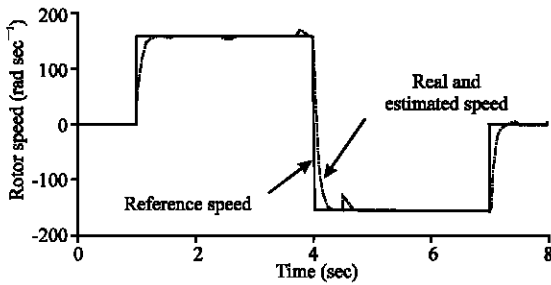

Fig. 5: Real and estimated rotor speed

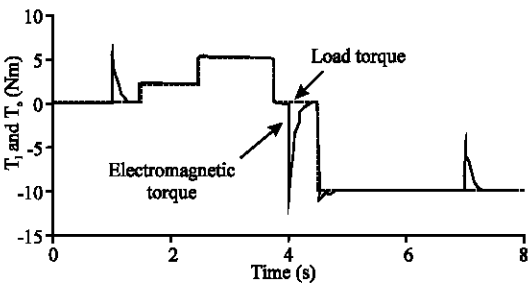

Fig. 6: Electromagnetic and load torque

the set point is changed to $-157 \text{ rad sec}^{-1}$ at $t = 4 \text{ sec}$ and at $t = 7 \text{ sec}$ the reference speed is changed to zero again. It is clear that the speed response exhibits good performances at both steady state and dynamic regimes.

Figure 6 depicts the trajectories of the electromagnetic and load torques. The reference load is set to 2 Nm at $t = 1.5 \text{ sec}$, then the set point is changed to 5 Nm at $t = 2.5 \text{ sec}$. between $t = 3.5$ and 4.5 sec it is set to zero and then it is changed to the nominal value (10 Nm).

The real and the estimated rotor flux components, when the motor is running at high speed, are given by Fig. 7a and b. These figures show that the real and the estimated rotor fluxes are in close agreement.

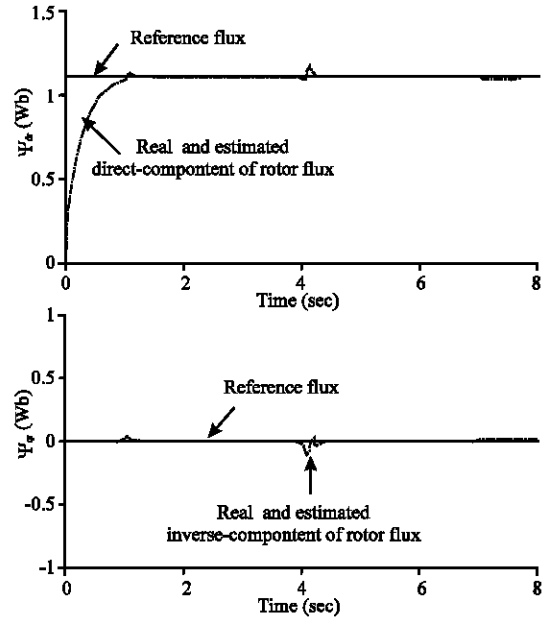

Fig. 7: Real and estimated rotor flux linkages at high speed range: (a) direct component, (b) quadratic component

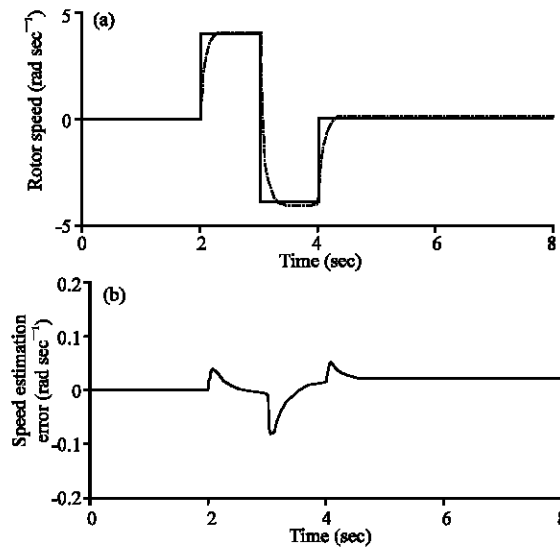

Fig. 8: Real and estimated rotor speed at low and zero speeds

For the investigation of the behavior of the IM at low speeds, first the reference speed is set to 0 rad sec^{-1} and at $t = 2 \text{ sec}$ it is changed to 4 rad sec^{-1} then at $t = 3 \text{ sec}$ is changed to -4 rad sec^{-1} and finally at $t = 7 \text{ sec}$ it is fixed to 0 rad sec^{-1} . The error between the real and estimated speeds is given by Fig. 8b. It can be see

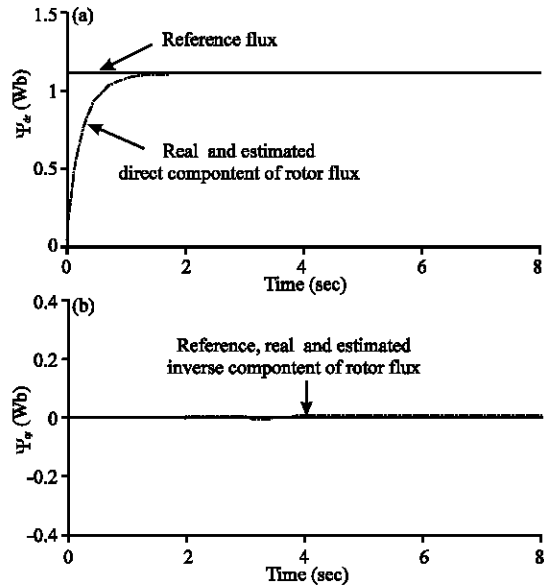

Fig. 9: Real and estimated rotor flux linkages at low and zero speed range: (a) direct component, (b) quadratic component

from these results that the performance of the proposed speed sensorless control scheme is satisfactory.

The reversal speed response of the induction motor is shown in Fig. 5 at high speeds and under different levels of load torque and in Fig. 8a at low speeds. The gotten results show the effectiveness of the proposed control scheme even at low and zero speeds. Figure 9a and b illustrates respectively the real and estimated direct and quadratic components of the rotor fluxes at low speeds.

CONCLUSION

The study presented an effective and robust sensorless vector control of IM based on both MRAS and LO forming together a full adaptive speed observer. The complexity of the algorithm is reduced by using analytical relations to obtain directly the Luenberger gain matrix L as function of the electrical velocity ω_e and the proportional constant k . However, for industrial applications it is required that the computational complexity is not very high. The simulation results show that this adaptive speed observer offers good performances at nominal and low speeds (even at zero speed) and it is robust to load torque variations. Being the effectiveness of the speed observer based on right rotor flux detection, the drive performance is strictly connected to the rotor flux observer. Therefore, the characteristic of the observer, in terms of stability, accuracy and robustness, critically influence those of the drive. This

method is extremely interesting, as it is able to increase the performance of the sensorless systems in terms of low speed behavior, dynamical and statical compartment.

REFERENCES

Besancon, G., Q. Zhang and H. Hammouri, 2002. High Gain Observer Based State and Parameter Estimation in Nonlinear Systems. IFAC, 15th Triennial World Congress, Barcelona, Spain, pp: 1-6.

Ben Hamed M. and L. Sbita, 2006. Speed sensorless indirect stator field oriented control of induction motor based on Luenberger observer. In: Proc. IEEE. ISIE Conf. Montréal, Québec, Canada, 3: 2473-2478.

Blaschke, F., 1972. The Principle of Field Orientation as Applied to the New Transvector Close-Loop Control System for Rotating-Field Machines. Siemens Rev., 1 (34): 217-220.

Kim, S.M., W.Y. Han and S.J. Kim, 2004. Design of a New Adaptive Sliding Mode Observer for Sensorless Induction Motor Drive. Elec. Power Syst. Res., No. 70, pp: 16-22.

Kojabadi, H.M., L. Chang and R. Draiswami, 2005. A MRAS-Based Adaptive Pseudoreduced-Order Flux Observer for Soensorless Induction Motor Drives. IEEE. Trans. Power Elec., 20 (4): 930-938.

Kwon, T.S., M.H. Shin and D.S. Hyun, 2005. Speed Sensorless Stator Flux-Oriented Control of Induction Motor in the Field Weakening Region Using Luenberger Observer. IEEE. Trans. Power Elec., 20 (4): 864-869.

Lee, C.M. and C.L. Chen, 1998. Speed Sensorless Vector Control of Induction Motor Using Kalman-Filter-Assisted Adaptive Observer. IEEE. Trans. Ind. Elec., 45 (2): 359-361.

Lee, K.B. and F. Blaabjerg, 2006. Reduced-Order Extended Luenberger Observer Based Sensorless Vector Control Driven by Matrix Converter with Nonlinearity Compensation. IEEE. Trans. Ind. Elec., 53 (1): 66-75.

Messaoudi, M., L. Sbita and M.N. Abdelkrim, 2007a. On-line Rotor Resistance Estimation for Sensorless Indirect Vector Control of Induction Motor Drives. 4th IEEE Int. Multi-Conf. SSD Proc., Hammamet, Tunisia.

Messaoudi, M., L. Sbita and M.N. Abdelkrim, 2007b. A Robust Nonlinear Observer for States and Parameters Estimation and Online Adaptation of Rotor Time Constant in Sensorless Induction Motor Drives. Int. J. Phys. Sci., 2 (8): 217-225.

Sbita, L. and M. Ben Hamed, 2007a. Fuzzy Controller and ANN Speed Estimation for Induction Motor Driver. 4th IEEE International Multi-Conference SSD7 Proc., Hammamet, Tunisia.

- Sbita, L. and M. Ben Hamed, 2007b. An MRAS-Based Full Order Luenberger Observer for Sensorless DRFOC of Induction Motors. ACSE Journal.
- Schauder, C., 1992. Adaptive Speed Identification for Vector Control of Induction Motors without Rotational Transducers. IEEE. Trans. Ind. Applic., 28 (5): 1054-1062.
- Simoes, M.G. and B. Bose, 2001. Neural Networks and Fuzzy Based Estimation for Feedback Signals for a Vector Controlled Induction Motor Drive. IEEE. Trans. Ind. Applic., 31 (3): 620-629.
- Vas, P., 1998. Sensorless Vector and Direct Torque Control. Oxford University Press, pp: 729.