

## Unified Power Quality Conditioner with Fuzzy Logic, Neural Network and Neuro Fuzzy Controllers for Power Quality Improvement

<sup>1</sup>D. Rajasekaran and <sup>2</sup>Subhransu Sekhar Dash

<sup>1</sup>Department of Electrical and Electronics Engineering,

R.M.D. Engineering College, 601 206 Chennai, Tamilnadu, India

<sup>2</sup>Department of Electrical and Electronics Engineering, SRM University,  
603 203 Chennai, Tamilnadu, India

**Abstract:** The major power quality issues are voltage sag, voltage swell and voltage harmonics in distribution system. These power quality issues are solved by custom power conditioning devices such as Dynamic Voltage Restorer (DVR), Distributed Static Compensator (DSTATCOM) and Unified Power Quality Conditioner (UPQC). This study presents the ability of Unified Power Quality Conditioner (UPQC) to mitigate voltage sag, voltage swell and voltage harmonics in distribution system. UPQC is modeled in MATLAB-SIMULINK environment with Fuzzy Logic (FL), Neural Network (NN) and Neuro Fuzzy (NF) controllers. The performances of UPQC with three controllers are compared and from comparison it is concluded that UPQC with NF controller effectively mitigates voltage sag, voltage swell and voltage harmonics.

**Key words:** Power quality, UPQC, voltage sag, voltage swell, voltage harmonics, IGBT, VSI, MATLAB/SIMULINK, fuzzy logic, neural network, neuro fuzzy, energy storage system, total harmonic distortion

### INTRODUCTION

Voltage sag, voltage swell and voltage harmonics are the most important power quality problem. Sensitive equipments used in industries and domestic are not tolerating these power quality issues (Dugan *et al.*, 2003; Singh, 2009). UPQC is a combination of series and shunt Active Power Filters (APF) connected to a common DC link voltage as shown in Fig. 1. UPQC is modeled either with voltage-source inverter or current source inverter (Pal *et al.*, 2010). In this study, UPQC is modeled by using Voltage Source Inverters (VSIs).

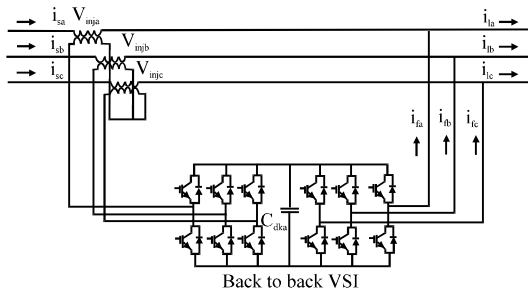

Fig. 1: Block diagram of UPQC

To make input current sinusoidal, shunt APF inject a compensating harmonic current and the series APF inject a compensating voltage to make load voltage sinusoidal (Kumar and Sastry, 2011). This study investigates the ability of UPQC with FL, NN and NF to mitigate voltage sag, swell and harmonics. UPQC with three controllers modeled in MATLAB-SIMULINK environment. The performances of UPQC with three controllers are compared. Results show that UPQC with NF controller effectively mitigates voltage sag, swell and harmonics.

### MATERIALS AND METHODS

Figure 2 shows distribution system under study with UPQC. The UPQC is connected in-between the source and load, to protect the load from voltage sag, swell and harmonics. Voltage sag, swell and harmonics are realized using RL load, RC load and Rectifier type load, respectively. Three different controllers such as FL, NN and NF are used for UPQC to mitigate the above mentioned issues. Each controller is discussed in study.

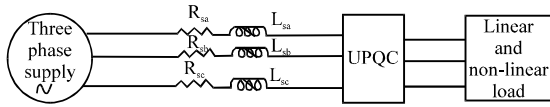

Fig. 2: Distribution system under study with UPQC

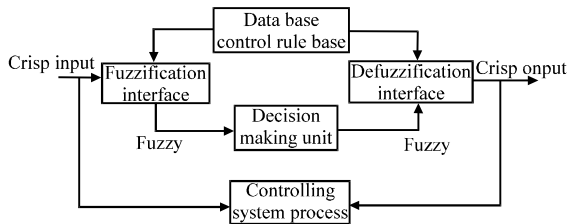

Fig. 3: Fuzzy logic controller

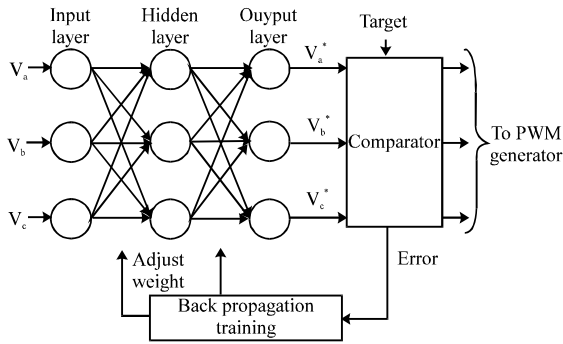

Fig. 4: Neural network controller

Table 1: Fuzzy rule base

E/AE	NB	NM	NS	Z	PS	PM	PB
NB	NB	NB	NB	NB	NM	NS	Z
NM	NB	NB	NB	NM	NS	Z	PS
NS	NB	NB	NM	NS	Z	PS	PM
Z	NB	NM	NS	Z	PS	PM	PB
PS	NM	NS	Z	PS	PM	PB	PB
PM	NS	Z	PS	PM	PB	PB	PB
PB	Z	PS	PM	PB	PB	PB	PB

**The fuzzy logic controller:** Figure 3 shows the block diagram of FL controller (Mikkili and Panda, 2011). Fuzzy rules are framed by expert experience or knowledge database (Saad and Zellouma, 2009). The fuzzy rule base is shown in Table 1 (Mikkili and Panda, 2012).

**The neural network controller:** NN controller consists of three neuron layers. The three layers are input layer, the hidden layer and the output layer. The output from NN is received by comparator and finally the output from comparator is applied to PWM generator to trigger VSI as shown in Fig. 4.

**The neuro fuzzy controller:** NF controller combines the feature of fuzzy and neural networks. Figure 5 shows

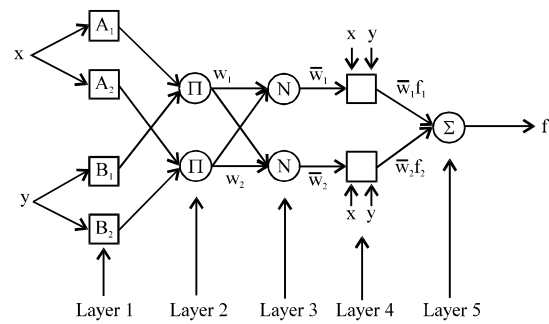

Fig. 5: Neuro fuzzy controller

diagram for NF controller. It consists of 5 layers such as the fuzzy layer, product layer, normalized layer, defuzzify layer, total output layer (Abdelkhalek *et al.*, 2010).

## RESULTS AND DISCUSSION

UPQC is simulated by using MATLAB/Simulink with FL, NN and FN controllers. Table 2 shows system parameters.

**System without UPQC:** Initially for 0-0.05 sec the load voltage is not find any issues such as sag, swell and harmonics. At 0.05 sec RL and rectifier type load is connected which leads to voltage sag. When load is removed suddenly at 0.05 sec from system, the system voltage rise, i.e., voltage swell occurs. Figure 6-8 show source voltage, load voltage with sag and load voltage with swell, respectively. The voltage sag and voltage swell occurs from 0.05-0.15 sec.

Figure 9-11 show FFT analysis of source voltage, load voltage with sag and load voltage with swell, respectively. The THD values of source voltage, voltage sag and voltage swell are 0.04, 43.21 and 26.08%, respectively. The THD value of system without UPQC is given in Table 3.

**Voltage sag, voltage swell and harmonics mitigation by UPQC with fuzzy logic controller:** Figure 12 and 13 show load voltage after mitigation for voltage sag and voltage swell, respectively by UPQC with FL controller. FFT analyses of mitigated voltages are shown in Fig. 14 and 15. The THD values of mitigated load voltage for voltage sag and voltage swell are 0.62 and 0.33%, respectively. The THD values of load voltage without and with mitigation by UPQC with FL controller are given in Table 4.

**Voltage sag, voltage swell and harmonics mitigation by UPQC with neural network controller:** Figure 16 and 17 show load voltage after mitigation for voltage sag and

Table 2: System parameters

Parameters	Values
Supply voltage phase to phase	380 V
Source resistance	0.1 $\Omega$
Source inductance	1 mH
Line frequency	50 Hz
Load	Diode rectifier
	Snubber resistance R = 500 $\Omega$
	Snubber capacitance C = 250e-9 F
Load resistance	15 $\Omega$
Load inductance	60 mH
DC link capacitance	5000e-6 F
DC link voltage	500 V

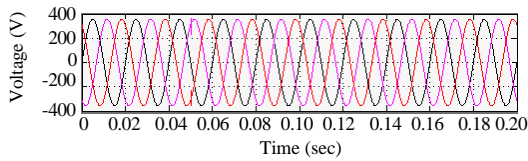

Fig. 6: Source voltage

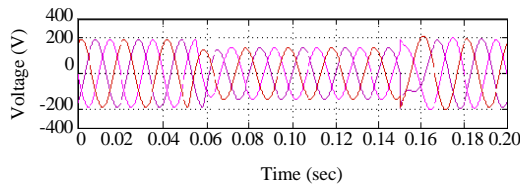

Fig. 7: Load voltage with sag

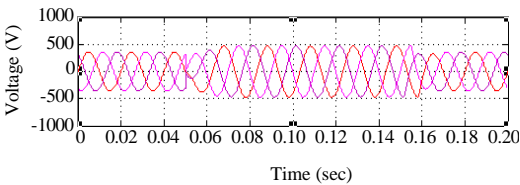

Fig. 8: Load voltage with swell

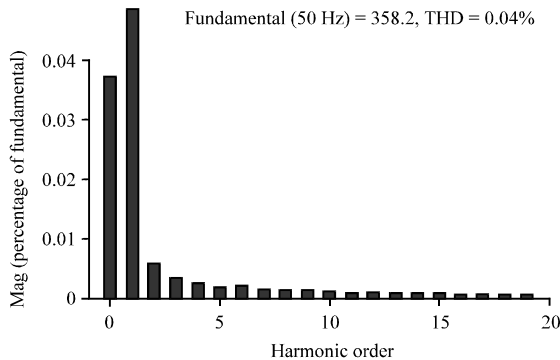

Fig. 9: FFT analysis source voltage

voltage swell, respectively by UPQC with NN controller. FFT analyses of mitigated voltages are shown in Fig. 18 and 19. The THD values of mitigated load voltage for voltage sag and voltage swell are 0.45 and 0.29%,

Table 3: THD values of the system without UPQC

THD	Values (%)
Without UPQC	
Load voltage with sag	43.21
Load voltage with swell	26.08

Table 4: THD values of load voltage without and with mitigation by UPQC with FL controller

THD	Values (%)
Without UPQC	
Load voltage with sag	43.21
Load voltage with swell	26.08
With UPQC	
Sag mitigated load voltage	0.62
Swell mitigated load voltage	0.33

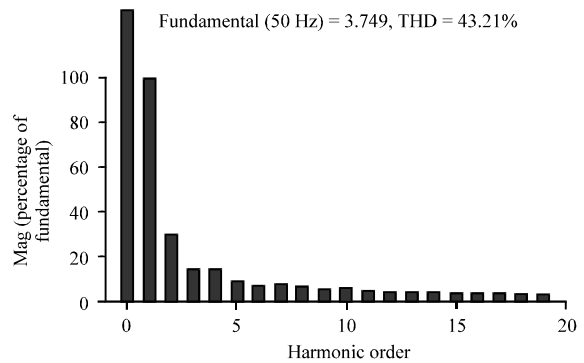

Fig. 10: FFT analysis of load voltage with sag

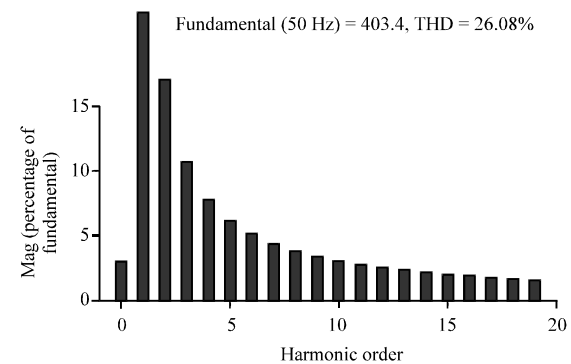

Fig. 11: FFT analysis of load voltage with swell

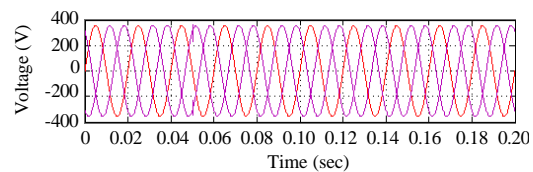

Fig. 12: Load voltage after sag mitigation by UPQC with FL controller

respectively. The THD values of load voltage without and with mitigation by UPQC with NN controller are given in Table 5.

Table 5: THD values of load voltage without and with mitigation by UPQC with NN controller

THD	Values(%)
<b>Without UPQC</b>	
Load Voltage with sag	43.21
Load voltage with swell	26.08
<b>With UPQC</b>	
Sag mitigated load voltage	0.45
Swell mitigated load voltage	0.29

Table 6: THD values of load voltage without and with mitigation by UPQC with NF controller

THD	Values(%)
<b>Without UPQC</b>	
Load voltage with sag	43.21
Load voltage with swell	26.08
<b>With UPQC</b>	
Sag mitigated load voltage	0.29
Swell mitigated load voltage	0.18

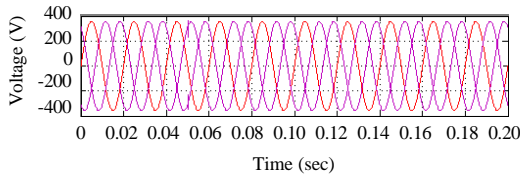

Fig. 13: Load voltage after swell mitigation by UPQC with FL controller

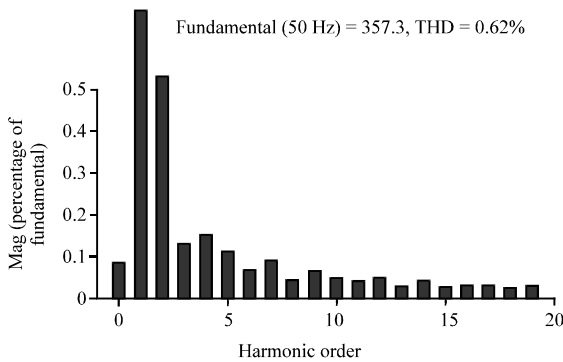

Fig. 14: FFT analysis of load voltage after Sag mitigation by UPQC with FL controller

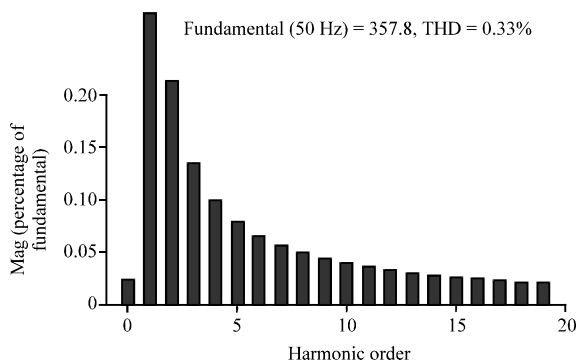

Fig. 15: FFT analysis of load voltage after swell mitigation by UPQC with FL controller

**Voltage sag, voltage swell and harmonics mitigation by UPQC with neuro fuzzy controller:** Figure 20 and 21 show load voltage after mitigation for voltage sag and voltage swell, respectively by UPQC with NF controller. FFT analyses of mitigated voltages are shown in

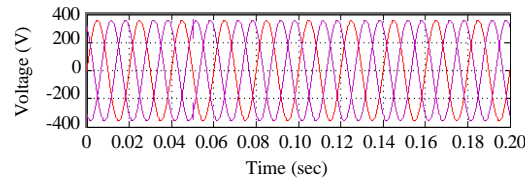

Fig. 16: Load voltage after sag mitigation by UPQC with NN controller

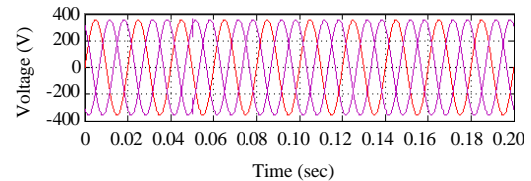

Fig. 17: Load voltage after swell mitigation by UPQC with NN controller

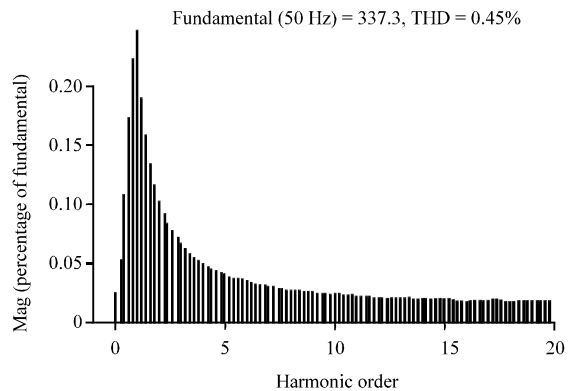

Fig. 18: FFT analysis of load voltage after sag mitigation by UPQC with NN controller

Fig. 22 and 23. The THD values of mitigated load voltage for voltage sag and voltage swell are 0.29 and 0.18%, respectively. The THD values of load voltage without and with mitigation by UPQC with NF controller are given in Table 6.

**Comparison of UPQC with fuzzy logic, neural network and neuro fuzzy controllers:** Performance of UPQC with FL, NN and NF controllers for voltage sag and voltage

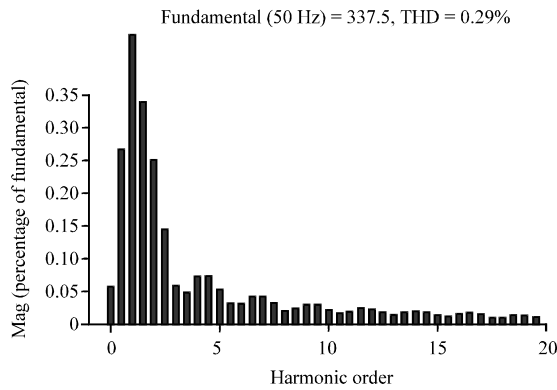

Fig. 19: FFT analysis of load voltage after swell mitigation by UPQC with NN controller

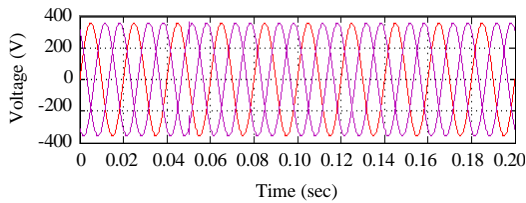

Fig. 20: Load voltage after sag mitigation by UPQC with NF controller

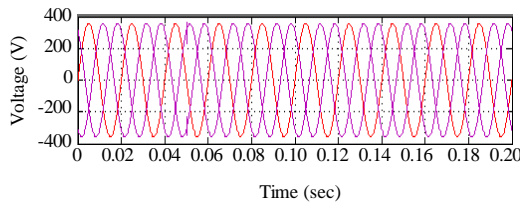

Fig. 21: Load voltage after swell mitigation by UPQC with NF controller

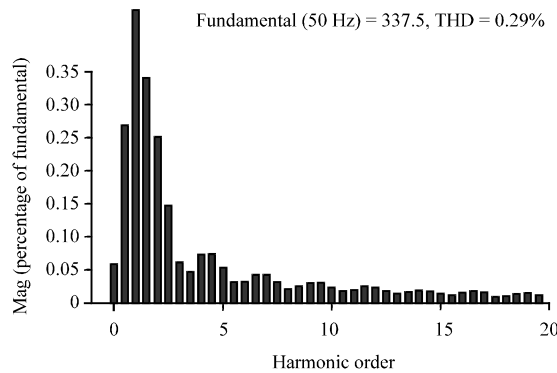

Fig. 22: FFT analysis of load voltage after sag mitigation by UPQC with NF controller

swell mitigation and THD are compared and given in Table 7. The performances of UPQC with FL, NN and NF

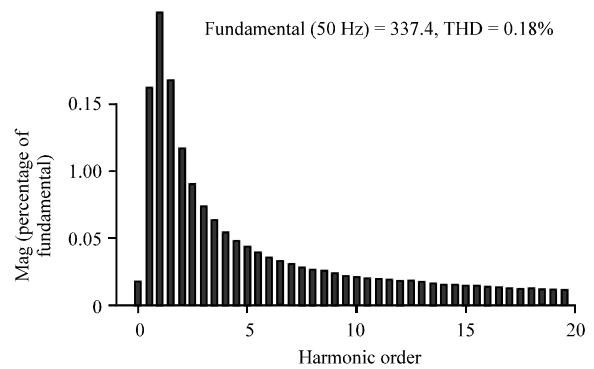

Fig. 23: FFT analysis of load voltage after Swell mitigation by UPQC with NF controller

Table 7: Comparison of UPQC with FL, NN and NF controller

Factors	Controller		
	FL	NN	NF
Load voltage THD after sag mitigation (%)	0.62	0.45	0.29
Load voltage THD after swell mitigation (%)	0.33	0.29	0.18
Load voltage after mitigation	377.00	375.00	379.00
Error in load voltage after mitigation (%)	0.03	0.05	0.01

controllers are compared. The simulation results show UPQC with NF controller effectively mitigates voltage sag, voltage swell and voltage harmonics in distribution system compared to FL and NN controllers.

### CONCLUSION

Unified Power Quality Conditioner (UPQC) is used to mitigate voltage sag, swell and harmonics in distribution system. Three different controllers such as Fuzzy Logic (FL), Neural Network (NN) and Neuro Fuzzy (NF) are used. UPQC is simulated with FL, NN and NF in MATLAB-SIMULINK environment. The performances of UPQC with three controllers are compared. The simulation results show UPQC with Neuro Fuzzy (NF) controller effectively mitigates voltage sag, swell and harmonics in distribution system compared to Fuzzy Logic (FL) and Neural Network (NN) controllers.

### REFERENCES

Abdelkhalik, O., C. Bbenachaiba, B. Gasbaoui and A. Nasri, 2010. Using of ANFIS and FIS methods to improve the UPQC performance. *Int. J. Eng. Sci. Technol.*, 2: 6889-6901.

Dugan, R.C., S. Santoso, M.F. McGranaghan and H.W. Beaty, 2003. *Electrical Power Systems Quality*. 2nd Edn., McGraw-Hill, New York, ISBN-10: 007138622X, Pages: 528.

- Kumar, K.S.R. and S.V.A.R. Sastry, 2011. Application of PI, fuzzy logic and ANN in improvement of power quality using unified power quality conditioner. *Int. J. Comput. Sci. Eng. Technol.*, 1: 214-217.
- Mikkili, S. and A.K. Panda, 2011. RTDS hardware implementation and simulation of 3-ph 4-wire SHAF for mitigation of current harmonics with p-q and  $I_d$ - $I_q$  control strategies using fuzzy logic controller. *Int. J. Emerg. Electr. Power Syst.*, Vol. 12. 10.2202/1553-779X.2758.
- Mikkili, S. and A.K. Panda, 2012. Real-time implementation of PI and fuzzy logic controllers based shunt active filter control strategies for power quality improvement. *Int. J. Electr. Power Energy Syst.*, 43: 1114-1126.
- Pal, Y., A. Swarup and B. Singh, 2010. Performance of UPQC for power quality improvement. *Proceedings of the Power India, 2010 Joint International Conference on Power Electronics, Drives and Energy Systems*, December 20-23, 2010, New Delhi, pp: 1-7.
- Saad, S. and L. Zellouma, 2009. Fuzzy logic controller for three-level shunt active filter compensating harmonics and reactive power. *Electr. Power Syst. Res.*, 79: 1337-1341.
- Singh, G.K., 2009. Power system harmonics research: A survey. *Eur. Trans. Elect. Power*, 19: 151-172.