

Energy Efficient Polynomial Time Resource Channelized Framework for Data Communication in MANET

¹S. Jayachitra and ²C. Nelson Kennedy Babu

¹Shree Satyam College of Engineering and Technology, Salem,
637301 Tamil Nadu, India

²Dhanalakshmi Srinivasan College of Engineering, Coimbatore,
641105 Tamil Nadu, India

Abstract: Energy efficient and bandwidth allocation on data forwarding in mobile ad hoc network have been extensively studied in the literature. However, such allocation models typically result in minimized bandwidth and involve high energy consumption with implementation complexity. In this study to improve the energy and bandwidth utilization, a framework called Energy Efficient Polynomial Time Resource Channelized (EE-PTRC) for data communication in MANET is introduced. The EE-PTRC includes two main parts. In the first part the resource conserved channels are evaluated by means of deploying bandwidth allocation strategy. Bandwidth allocation of the intermediate nodes, are calculated with traffic condition based on the channels and load balancing capacity (i.e., weight) of the geo-optimized route path. Polynomial Time Resource Conserved Channelized model is designed aiming at reducing the energy consumption and therefore minimizing the data delivery overhead. In Polynomial Time Resource model, the energy requirements for the intermediate nodes to deliver the data are summed together. The data delivery means are finally generated with both overall energy requirement and the bandwidth consumption rate. With this, the data communication framework maximizes the bandwidth utilization and data delivery rate and performs experimental evaluation on factors such as energy consumption, density of mobile nodes and data delivery overhead. Experimental analysis shows that EE-PTRC framework is able to reduce the data delivery overhead during data communication in MANET by x% and reduce the energy consumption by y% compared to the state-of-the-art works.

Key words: Polynomial time, resource channelized, bandwidth allocation, geo-optimized, data delivery, load balancing

INTRODUCTION

Energy efficient data communication is one of the key aspects in mobile ad hoc network. With the objective of improving the energy efficiency model, many research works had been concentrated by different resource persons. Distributed Cache Invalidation Mechanism (DCIM) (Almotairi and Shen, 2013) was designed with the objective of reducing the overhead occurring in traffic by applying pull-based algorithm. Energy Efficient Routing (EER) (Jinhua and Xin, 2011) was introduced with the objective of reducing the energy consumption during transmission using progressive routing. A routing measure based on the channel awareness was introduced by Chen *et al.* (2011) by applying multipath distance vector resulting in the improvement of network performance (Yi *et al.*, 2011). Reservation based channel access was performed to reduce energy and minimum bandwidth. Two Constrained Markov Decision model was

introduced by Niyato *et al.* (2011) aiming at reducing the communication cost. Though network performance and energy consumption was improved but data delivery rate was not concentrated in the above methods. To minimize the data delivery rate, in EE-PTRC framework, polynomial time model is introduced. With the objective of improving the throughput during routing by Dong *et al.* (2011), multicast routing was introduced using measurement-based detection and accusation-based reaction techniques. Chenn *et al.* (2011), multicast throughput under Gaussian channel model was introduced aiming at improving the rate of throughput. A novel distributed multi-channel medium access control model was introduced aiming at improving the rate of throughput. Li *et al.* (2015) with the objective of minimizing the energy consumption, non-linear programming model was introduced. Store-Carry and Forward (SCF) (Kolios *et al.*, 2014) mechanism was introduced to minimize the energy during routing. One of the solutions for minimizing the

energy cost during data communication in MANET is the design of energy-efficient routing model. In (Vazifehdan *et al.*, 2014), Reliable Minimum Energy Cost Routing (RMECR) was designed to provide an energy efficient mechanism. Throughput maximization (Lee *et al.*, 2012) was addressed using randomization approach. An Unobservable Secure On Demand Routing (USOR) (Wan *et al.*, 2012) was designed aiming at improving the privacy during routing.

In order to improve the data dissemination, Connected Dominating Set (CDS) (Ros *et al.*, 2012) was used resulting in intermittent connectivity. Resource Biasing Approach (RBA) (Singh *et al.*, 2012) used fair allocation model to improve the rate of throughput. Though throughput and energy optimization was addressed in the above said methods, the bandwidth utilization remained unaddressed.

To address the issues related to bandwidth utilization, EE-PTRC framework used two hop propagations. In order to provide bandwidth guarantee, a new path weight was measured (Hou *et al.*, 2012), to support quality of service. With multi-hop data transmission, MANETs received a great deal of attention. In Position-based Opportunistic Routing (POR) protocol was introduced aiming at reducing the data delivery overhead (Yang *et al.*, 2012). Back pressure adaptive routing algorithm was introduced aiming at extending the network lifetime using routing and scheduling components (Bui *et al.*, 2013).

An energy efficient communication scheme called Random Cast was designed by Lim *et al.* (2009) using dynamic source routing resulting in minimizing total energy consumption during routing. In a robust model for energy efficient tracking was introduced resulting in the accuracy of object tracking (Bhattacharya *et al.*, 2015). Based on the aforementioned methods and techniques, in this study, an efficient data communication framework called Energy Efficient Polynomial Time Resource Channelized (EE-PTRC) is designed with the objective of improving the energy and bandwidth utilization during data forwarding in MANET.

MATERIALS AND METHODS

Design of energy efficient polynomial time resource channelized framework: This study, describes the proposed framework called Energy Efficient Polynomial Time Resource Channelized (EE-PTRC) for efficient data communication in MAENT. It starts with the design of Two Hop Propagate Bandwidth Allocation model aiming at improving the bandwidth utilization and therefore the data delivery rate. The framework is also designed in such a manner to improve energy performance by introducing Polynomial Time Resource Conserved Channelized model and forwarding the data packets without significant impact on network performance. Figure 1 shows the block diagram of EE-PTRC framework.

The figure given above shows the block diagram of Energy Efficient Polynomial Time Resource Channelized framework. The framework includes two main parts. The

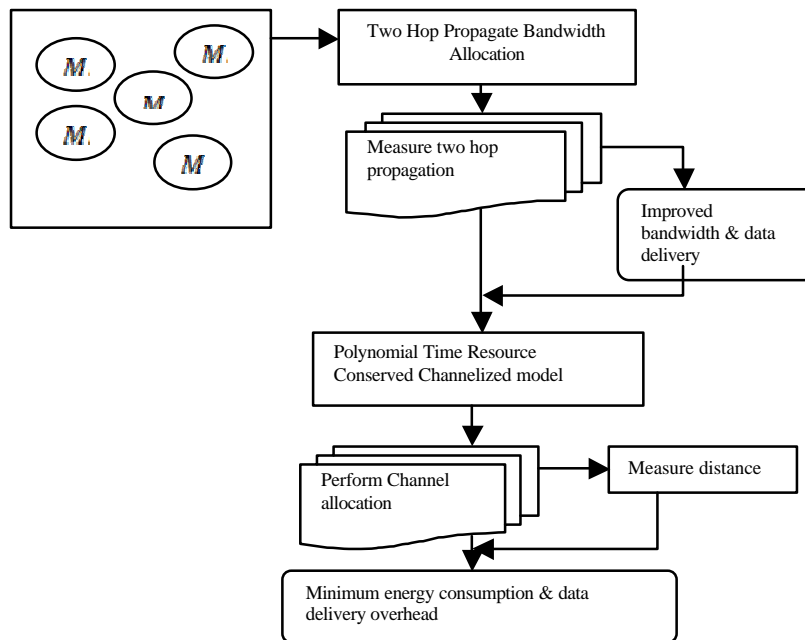

Fig. 1: Block diagram of energy efficient polynomial time resource channelized framework

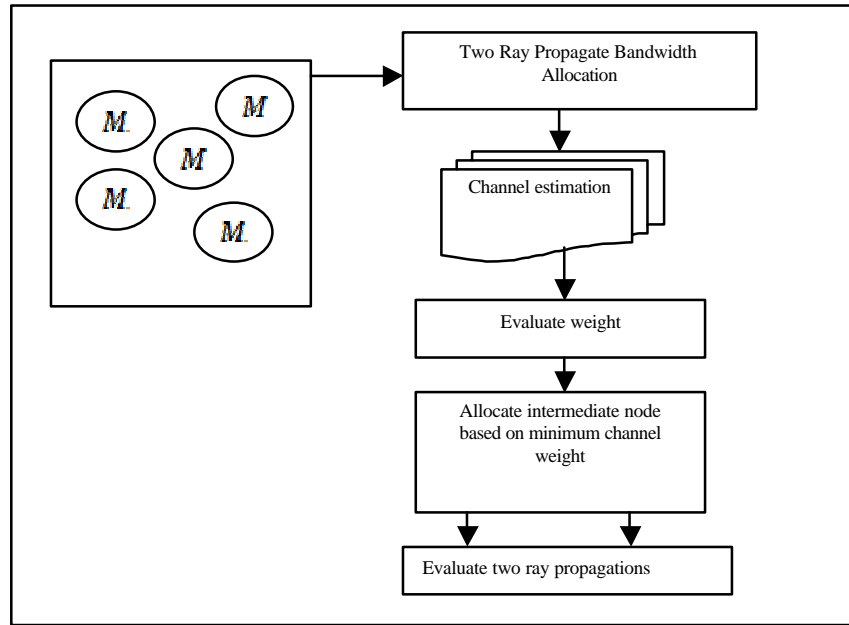

Fig. 2: Block diagram of two hop propagate bandwidth allocation model

first part improves the bandwidth utilization and data delivery rate by applying Two Hop Propagate Bandwidth Allocation model. Next, with the objective of minimizing the energy consumption during data communication in MANET, an efficient Polynomial Time Resource Conserved Channelized model is designed. The elaborate description of the framework is provided in the forthcoming sections.

Design of two hop propagate bandwidth allocation model:

In this study, the resource conserved channels are evaluated by means of deploying Two Hop Propagate Bandwidth Allocation model (THPBA). Using THPBA model, the intermediate nodes in Mobile Ad Hoc Network (MANET) forward data packets on behalf of the source mobile node, thus minimizing the transmission power consumed by the network and therefore improving the bandwidth allocation.

In THPBA model, the resource considered is not the channel but a resource conserved channel with the objective of improving the bandwidth utilization and therefore improve the data delivery rate. Figure 2 shows the block diagram of Two Hop Propagate Bandwidth Allocation model.

As shown in the Fig. 2, the Two Hop Propagate Bandwidth Allocation model initially identifies the channels through which the data packets can be sent from the source node to the destination node. On successful identification of the channels, the channels which are

possessing maximum weight is then obtained and assigned with as the hop. Next, the Two Hop Propagate measures the two hops to arrive at due to the fading and channel problems in mobile ad hoc network. This in turn improves the bandwidth utilization and data delivery rate in MANET.

To illustrate the Two Hop Propagate Bandwidth Allocation model, let us consider the network as a graph ‘G = (V, E)’ with mobile nodes represented as ‘Mn₁, MN₂, ..., MN_n’ the graph is mathematically formulated as given below:

$$G = (V, E), V \rightarrow \text{Vertices} \ \& \ E \rightarrow \text{Edges} \quad (1)$$

From Eq. 1, the mobile nodes represent the vertices where ‘V ∈ Mn₁, MN₂, ..., MN_n’ and edges ‘E ∈ Channel’ represents the channels to several neighboring mobile nodes. All mobile nodes in the network join either they belong within the channel area or having destinations nodes that are within the channel area. Then, a set of ‘n’ connection are existing in the network. Each connection in THPBA model is then mathematically formulated as:

$$SN_n \rightarrow DN_n = (SN_n, DN_n, Channel, W_n) \quad (2)$$

where, Sn_n, Dn_n, Channel, W_n denotes the source node, destination node, channel and the weight for the channel between the source and the intermediate node, respectively. Figure 3 given below shows the channel

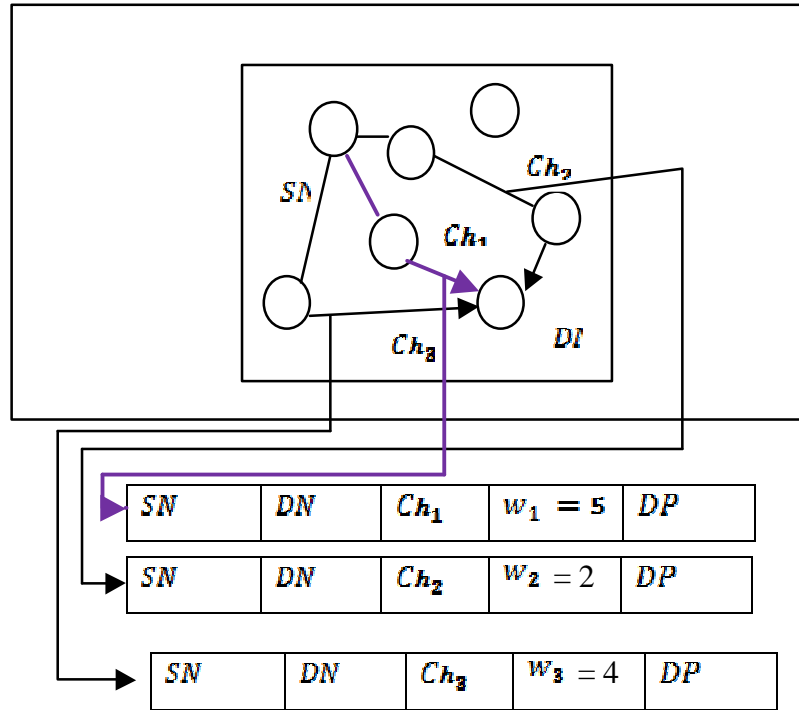

Fig. 3: Block diagram of channel organization

organization used in the design of THPBA model. As illustrated in the figure, the proposed EE-PTRC using THPBA model manages multiple channels.

The block diagram of channel organization used for THPBA model uses the channel as the basis to send the data packets 'DP' from the source node 'SN' to the destination node 'DN'. The number of channels in the network depends upon the total mobile nodes in the network.

From the above figure, in order to send the data packets to the destination node, the source node 'SN' senses three channels 'Sh₁, Ch₂ and Ch₃' respectively. The weight possessing higher value is assigned with the channel for the specific source node through which the data packets are transmitted to the destination node. The weight assigned is formulated as given Eq. 3:

$$\text{ChannelAllocation}(CA) = \sum_{i=1}^n \text{Ch}(\text{Max}(W_i)) \quad (3)$$

From Eq. 3, the channel possessing maximum weight is the final channel being allocated through which the data packets are sent from the source to the destination mobile nodes. So, as illustrated in the figure, channel 1 'Ch₁' has higher weight and therefore is assigned for transmission of data packets to the destination node.

Once the channel is selected, the proposed EE-PTRC then evaluates the distance separating the source mobile node and destination nodes using the Two Hop Propagate Bandwidth Allocation model. The distance is then formulated using two Hop propagation is given as below:

$$\text{Dis} = \text{FHP} = \left(\frac{\text{Trans}_j \times \text{Time}_{\text{Chi}}}{n} \right) \quad (4)$$

From Eq. 4, the distance 'Dis' is measured using the product of transmission to be taken place from the source node 'i' to the destination node 'j' and the time taken to arrive at the channel 'i'. Due to fading and channel problems with noise being observed in the channel, the proposed EE-PTRC uses the second Hop propagation aiming at improving the bandwidth utilization. The second hop propagation is then given as below:

$$\text{Dis} = \text{SHP} = \left(\frac{\text{Trans}_j \times \text{Time}_{\text{Chi}}}{n} \right) \quad (5)$$

From Eq. 5, the actual value of distance 'Dis' between the nodes 'MN_i' and 'MN_j' is obtained for each mobile node in the network based on the observed variations or the number of mobile nodes in the network. This in turn improves the bandwidth utilization. Figure shows the algorithmic description of Two Hop Propagation algorithm.

Algorithm A; Two hop propagation algorithm:

Input: Mobile Nodes ‘‘, Source Nodes ‘‘, Destination Nodes ‘‘
 Output: Improved data delivery rate at the destined node
 Step 1:Begin
 Step 2: For each Source Node ‘‘
 Step 3: For each Mobile Nodes ‘‘
 Step 4: Evaluate source to destination connection using Eq. 2
 Step 5: Evaluate channel allocation using Eq. 3
 Step 6: Evaluate First Hop Propagation using Eq. 4
 Step 7: Evaluate Second Hop Propagation using Eq. 5
 Step 8: End for
 Step 9: End for
 Step 10:End

As listed in algorithm, the algorithm includes four steps. The first step evaluates the source to destination connection based on the channel availability and weight. The second step performs the actual channel allocation where the minimum weight channel is selected for transmission of data packets between the source and destination mobile node. Finally, the third and fourth step performs the first and second hop propagation with the objective of improving the bandwidth utilization on the basis of the observed variations.

Design of polynomial time resource conserved channelized model: In this section, a Polynomial Time Resource Conserved Channelized (PTRSS) data delivery model which reduces the total energy consumed during routing and also guarantees that the total load on each mobile node and on each link does not exceed the channel capacity. This in turn minimizes the energy consumption and therefore the data delivery overhead.

Let us consider the mobile ad hoc network modeled as a directed graph ‘‘G = (V, E)’ where ‘V = V_{MN} × V_{IN}’ where ‘MN’ represents the set of mobile nodes and ‘IN’ represents the intermediate nodes through which the data packets are sent to the destination nodes. Here ‘E_{ij}’ represents the edges or the channels through which the data packets flow where ‘i ∈ V’ and ‘j ∈ V’ respectively.

The Polynomial Time Resource Conserved Channelized model is designed in such a way that each channels ‘E_{ij}’ has an analogous cost per data packet ‘Cost_{ij}’ with respect to time interval ‘Time_{ij}’ for each data packet and is given as:

$$E_{ij} = \sum_{i,j=1}^n \text{Cost}_{ij} \times \text{Time}_{ij} \tag{6}$$

From Eq. 6, the channel estimation is made by measuring the cost ‘Cost_{ij}’ with respect to time interval ‘Time_{ij}’. As a result, the data delivery overhead is reduced in a significant manner. Let ‘CHCost_{max}’ represent the maximum threshold of any channel cost and ‘CHStrength_{max}’ represent the maximum threshold of any

channel strength. Then, the energy consumption to transmit data packet from mobile node ‘MN_i’ to its intermediate neighbor node ‘MN_j’ is formulated as given below:

$$MN_i \rightarrow MN_j = \text{MAX}(\text{CHCost} + \text{CHStrength}) \times \text{Time}_{ij} \tag{7}$$

From Eq. 7, it is assumed that only one mobile node, to which the data packet is intended, consumes the energy whereas the other mobile nodes in the network though are the neighbors of the mobile nodes will remain in the sleep mode. As a result, no power is said to consume while the intermediate neighbor mobiles nodes are idle listening, therefore minimizing the energy consumption. Algorithm B given below shows the algorithmic description of Polynomial Time Resource Conserved algorithm.

Algorithm B; polynomial time resource conserved algorithm:

Input: Mobile Nodes ‘Mn₁ = MN₁MN₂, ..., MN_n’, Source Nodes ‘SN₁ = SN₁ SN₂, ..., SN_n’, Destination Nodes ‘Dn₁ = DN₁ DN₂, ..., DN_n’
 Output:
 Step 1: Begin
 Step 2: For each Source Nodes ‘SN_i’
 Step 3: For each Mobile Nodes ‘MN_i’
 Step 4: Evaluate cost per data packet for each channel using Eq. 6
 Step 5: Measure energy consumption based on the cost and time using Eq. 7
 Step 6: end for
 Step 7: end for

The Polynomial Time Resource Conserved algorithm involves two steps. For each source node and intermediate mobile nodes, in order to send the data packets and perform efficient communication the proposed EE-PTRC evaluates cost per data packet for each channel. Next, energy consumption is measured based on the cost and time resulting in the minimization of data delivery overhead.

Experimental settings: Energy Efficient Polynomial Time Resource Channelized (EE-PTRC) framework for data communication in MANET uses the NS-2 simulator with the network range of 1500×1500 m size. The number of mobile nodes selected for experimental purpose is 70 nodes that uses Random Way Point (RWM) model for EE-PTRC framework. The EE-PTRC framework uses Destination Sequence Based Distance Vector (DSDV) as routing protocol to perform the experimental work.

The EE-PTRC framework’s moving speed of the mobile nodes in MANET is about 5 m sec⁻¹ for each mobile node with a simulation rate of 50 milliseconds to perform single data packet transfer from source to destination node through intermediate nodes. The values

Table 1: Simulation setup

Parameters	Value
Protocols	DSDV
Network range	1500×1500 m
Simulation time	50 ms
Mobility model	Random way point
Number of nodes	10, 20, 30, 40, 50, 60, 70
Network simulator	NS 2.34
Network load	4 packets sec ⁻¹
Mobility speed	5 ms ⁻¹
Pause time	10 s

of each parameter for performing experiments are shown in Table 1. Experiment is conducted on the factors such as bandwidth utilization, data delivery rate, energy consumption and data delivery overhead for performing data communication in MANET. The results of the metrics of EE-PTRC framework is compared against the existing methods such as Distributed Cache Invalidation Method (DCIM) (Fawaz and Artail, 2013) and Energy Efficient Routing over MANET (EER) (Wang *et al.*, 2011) method.

RESULTS AND DISCUSSION

Performance metrics: The performance of Energy Efficient Polynomial Time Resource Channelized (EE-PTRC) framework is compared with the Distributed Cache Invalidation Method (DCIM) (Fawaz and Artail, 2013) and Energy Efficient Routing over MANET (EER) (Wang *et al.*, 2011) method. The performance is evaluated according to the following metrics.

Bandwidth consumption using BO-GIDF measures the amount of data that can be transmitted in a fixed amount of time. It is measured in terms of bits per second (bps). The formulation of bandwidth consumption is given as:

$$B = MN \times \text{Data}_T (\text{KB}) \times \text{Time} (\text{ms}) \quad (8)$$

From Eq. 8, the bandwidth consumption ‘B’ is measured based on mobile nodes ‘MN’, data being transmitted ‘Data_T’ and the time taken to transmit ‘Time’. It is measured in terms of bits per second (bps). The data delivery rate is measured which is the ratio of data packets sent and data packets received. The data delivery rate is measured in terms of percentage (%) and is formulated as given:

$$\text{DDR} = \left(\frac{\text{DP}_r}{\text{DP}_s} \right) \times 10_0 \quad (9)$$

From Eq. 9, the data delivery rate ‘DDR’ is measured using data packets received ‘DP_r’ and data packets sent ‘DP_s’ respectively. Energy consumption is the product of power consumed and the time taken to perform data communication in MANET. The energy consumption is formulated as given:

Table 2: Tabulation for bandwidth consumption

Mobile Nodes (MN)	Bandwidth consumption (bps)		
	EE-PTRC	DCIM	EER
10	642	805	970
20	680	805	917
30	725	930	1042
40	765	970	1082
50	810	1015	1127
60	849	1054	1166
70	885	1090	1195

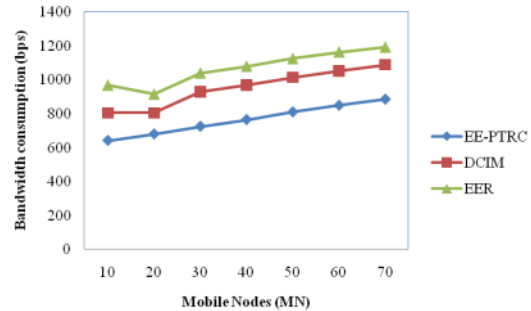

Fig. 4: Measure of bandwidth consumption

$$E = P \times T \quad (10)$$

From Eq. 10, the energy consumption ‘E’ is measured using the power ‘P’ and time ‘T’, respectively. It is measured in terms of Joules (J). Lower the energy consumption, more efficient the method is said to be. The data delivery overhead is the time taken to perform data communication with respect to the data size. The data delivery overhead is formulated as given:

$$\text{DDO} = \text{DS} \times \text{Time} (\text{Data Communication}) \quad (11)$$

From Eq. 11, the data delivery overhead ‘DDO’ is measured on the basis of the data size ‘DS’. It is measured in terms of milliseconds (ms). Lower the data delivery overhead, more efficient the method is said to be.

Scenario 1: Performance comparison of bandwidth consumption Table 2 represents the bandwidth consumption efficiency using NS simulator and comparison is made with two other methods, namely DCIM and EER (Wang *et al.*, 2011).

Figure 4 shows the result of bandwidth consumption efficiency versus the varying mobile nodes ranging between 10 and 70 KB. To better perceive the efficacy of the proposed EE-PTRC framework, substantial experimental results are illustrated in Fig. 4. The EE-PTRC framework is compared against the existing DCIM (Fawaz and Artail, 2013) and EER.

Table 3: Tabulation for data delivery rate

Data Packets (DP)	Data delivery rate (%)		
	EE-PTRC	DCIM	EER
10	80	70	60
20	82	74	69
30	85	78	73
40	78	70	65
50	83	75	70
60	85	78	73
70	88	80	75

Results are presented for different mobile nodes. The bandwidth consumption efficiency for data communication in MANET measures the amount of bandwidth consumed for different mobile nodes. Higher, the size of data, more successful the method is. The results reported here confirm that with the increase in the number of mobile nodes, the bandwidth consumption efficiency also increases. The process is repeated for 70 mobile nodes. As illustrated in Fig. 4, the proposed EE-PTRC framework performs relatively well when compared to two other methods DCIM (Fawaz and Artail, 2013) and EER (Wang *et al.*, 2011). The framework had better changes using the extensive Two Hop Propagate Bandwidth Allocation model. This is because in order to obtain the channels through which the data packets can be sent, the EE-PTRC framework uses the channel possessing maximum weight. This in turn improves the bandwidth consumption efficiency in MANET using EE-PTRC framework by 24.49% compared to DCIM and 40.37% compared to EER, respectively.

Scenario 2: Performance comparison of data delivery rate:

As listed in Table 3, the EE-PTRC framework measures the data delivery rate during data communication which is measured in terms of percentage (%). The data delivery rate using EE-PTRC framework offer comparable values than the state-of-the-art methods. In order to improve the data delivery rate with the increasing topological changes observed in MANET, the data packets for different nodes is considered. In the experimental setup, the data packets range from 10-70 bytes. The results for 70 different packets of varying size are illustrated in Fig. 5. The data delivery rate using our framework EE-PTRC offer comparable values than the state-of-the-art methods.

As shown in the Fig. 5, the proposed EE-PTRC framework offers comparatively increased data delivery rate than the state-of-the-art methods. Our framework differs from the DCIM and EER (Wang *et al.*, 2011) in that we have incorporated Two Hop Propagation algorithm. By applying this Two Hop Propagation algorithm, the channel allocation through which data communication has to be established is performed based on the channel

Table 4: Tabulation for energy consumption

Mobile Nodes (MN)	Energy consumption (J)		
	EE-PTRC	DCIM	EER
10	0.055	0.063	0.078
20	0.069	0.077	0.089
30	0.078	0.085	0.097
40	0.085	0.093	0.105
50	0.075	0.082	0.094
60	0.079	0.087	0.099
70	0.090	0.098	0.110

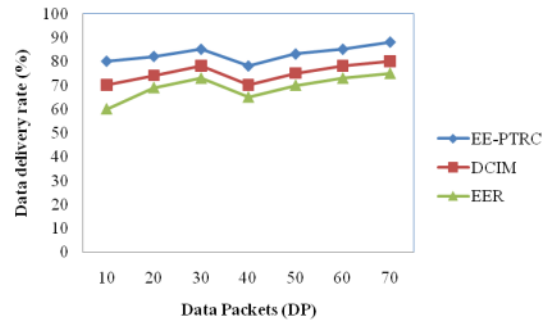

Fig. 5: Measure of data delivery rate

availability and weight based on a distance measure. This in turn helps in improving the data delivery rate using EE-PTRC framework compared to DCIM by 9.67% and 16.59% compared to EER.

Scenario 3: Performance comparison of energy consumption:

In Table 4, we further compare the energy consumption for identifying channel during routing in MANET using the EE-PTRC framework. The experiments were conducted using seven test cases in the range of 10 to 70 that measures the energy consumption in terms of joules (J).

Figure 6 given below shows the energy consumption for EE-PTRC framework, DCIM and EER (Wang *et al.*, 2011) versus increasing number of nodes in the range of 10-70. The energy consumption returned over DCIM and EER increases gradually as the number of nodes of mobile nodes gets increased are not linear because of the topological changes frequently observed in MANET.

From Fig. 6, it is illustrative that the energy consumption is reduced using the proposed framework EE-PTRC. For example when the number of nodes is 30, the percentage improvement of EE-PTRC framework compared to DCIM is 8.97% and 24.35% compared to EER, whereas when the number of nodes is 60 the improvements are around 10.12 and 25.31 percent compared to DCIM and EER respectively. This is because of the application of Polynomial Time Resource

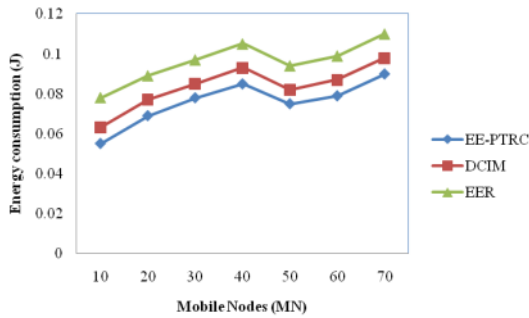

Fig. 6: Measure of energy consumption

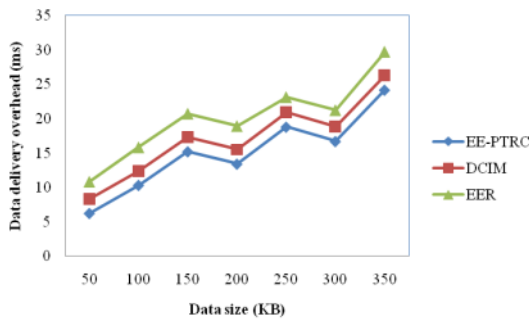

Fig. 7: Measure of data delivery overhead

Table 5: Tabulation for data delivery overhead

Data size (KB)	Data delivery overhead (ms)		
	EE-PTRC	DCIM	EER
50	6.2	8.3	10.8
100	10.3	12.4	15.8
150	15.2	17.3	20.7
200	13.4	15.5	18.9
250	18.8	20.9	23.1
300	16.7	18.8	21.2
350	24.2	26.3	29.7

Conserved Channelized data delivery model in EE-PTRC framework that sees to that the total load on each mobile node and on each link does not exceed the channel capacity. Therefore, the energy consumption during routing is reduced using the EE-PTRC framework by 10.41% compared to DCIM and 27.36% compared to EER, respectively.

Scenario 4: Performance comparison of data delivery overhead: Table 5 lists out the data delivery overhead provided by EE-PTRC framework and the two state-of-the-art methods (Fawaz and Artail, 2013; Wang *et al.*, 2011).

Figure 7 shows the data delivery overhead observed using three methods, EE-PTRC, DCIM and EER. From the figure, it is evident that the data delivery overhead is reduced in the proposed framework EE-PTRC compared to

DCIM and EER. This is because by selecting the data packet based on the cost with respect to the time, the data delivery overhead is reduced in a significant manner. Furthermore, with the application of Polynomial Time Resource Conserved algorithm, the resource is conserved based on the polynomial time, reducing the data delivery overhead in EE-PTRC framework by 16.59% in DCIM and 39.62% in EER.

CONCLUSION

Energy Efficient Polynomial Time Resource Channelized (EE-PTRC) framework to improve the data communication in mobile ad hoc network is introduced. We then showed how this framework can be extended to incorporate Two Hop Propagate Bandwidth Allocation model. This Two Hop Propagate Bandwidth Allocation model improves the bandwidth consumption efficiency and the data delivery rate by first estimating the channel based on the weight and therefore allocating the node with data packets based on maximum channel weight. Polynomial Time Resource Conserved Channelized model improves the energy efficiency and therefore reduces the data delivery overhead by applying the cost function with respect to the time interval. Next, the introduced Polynomial Time Resource Conserved algorithm works on improving the data delivery overhead and energy consumption through the time occurrence of packet arrival because of efficient data communication. We compared the performance with many different system parameters, and evaluated the performance in terms of different metrics, such as bandwidth utilization, data delivery rate, energy consumption and data delivery overhead. The results show that EE-PTRC framework offers better performance with an improvement of the data delivery rate by 13.13% and reduced the bandwidth consumption by 32.43% compared to DCIM and EER respectively.

REFERENCES

Almotairi, K.H. and X.S. Shen, 2015. A distributed multi-channel MAC protocol for ad hoc wireless networks. *IEEE. Trans. Mobile Comput.*, 14: 1-13.

Bhattacharya, S., H. Blunck, M.B. Kjargaard and P. Nurmi, 2015. Robust and energy-efficient trajectory tracking for mobile devices. *Mobile Comput. IEEE. Trans.*, 14: 430-443.

Chen, X., H.M. Jones and D. Jayalath, 2011. Channel-aware routing in MANETs with route handoff. *IEEE. Trans. Mobile Comput.*, 10: 108-121.

- Dong, J., R. Curtmola, C.N. Rotaru, 2011. Secure high-throughput multicast routing in wireless mesh networks. *Mob. Comput. IEEE. Trans.*, 10: 653-668.
- Fawaz, K. and H. Artail, 2013. DCIM: Distributed cache invalidation method for maintaining cache consistency in wireless mobile networks. *IEEE. Trans. Mob. Comput.*, 12: 680-693.
- Hou, R., K.S. Lui, F. Baker and J. Li, 2012. Hop-by-hop routing in wireless mesh networks with bandwidth guarantees. *IEEE. Trans. Mobile Comput.*, 11: 264-277.
- Jinhua, Z. and W. Xin, 2011. Model and protocol for energy-efficient routing over mobile ad hoc networks. *IEEE Trans. Mobile Comput.*, 10: 1546-1557.
- Kolios, P., V. Friderikos and K. Papadaki, 2014. Energy-efficient relaying via store-carry and forward within the cell. *Mobile Comput. IEEE. Trans.*, 13: 202-215.
- Lee, H.W., E. Modiano and L.B. Le, 2012. Distributed throughput maximization in wireless networks via random power allocation. *IEEE. Trans. Mobile Comput.*, 11: 577-590.
- Li, M., P. Li, X. Huang, Y. Fang and S. Glisic, 2015. Energy consumption optimization for multihop cognitive cellular networks. *Mobile Comput. IEEE. Trans.*, 14: 358-372.
- Lim, S., C. Yu and C.R. Das, 2009. Random cast: An energy-efficient communication scheme for mobile Ad hoc networks. *IEEE Trans. Mobile Comput.*, 8: 1039-1051.
- Niyato, D., E. Hossain and P. Wang, 2011. Optimal channel access management with QoS support for cognitive vehicular networks. *IEEE. Trans. Mobile Comput.*, 10: 573-591.
- Ros, F.J., P.M. Ruiz and I. Stojmenovic, 2012. Acknowledgment-based broadcast protocol for reliable and efficient data dissemination in vehicular ad hoc networks. *IEEE. Trans. Mobile Comput.*, 11: 33-46.
- Singh, S., U. Madhow and E.M. Belding, 2012. Shaping throughput profiles in multihop wireless networks: A resource-biasing approach. *IEEE. Trans. Mobile Comput.*, 11: 367-376.
- Vazifehdan, J., R.V. Prasad and I. Niemegeers, 2014. Energy-efficient reliable routing considering residual energy in wireless ad hoc networks. *Mobile Comput. IEEE. Trans.*, 13: 434-447.
- Wan, Z., K. Ren and M. Gu, 2012. USOR: An unobservable secure on-demand routing protocol for mobile Ad Hoc networks. *IEEE Trans. Wireless Commun.*, 11: 1922-1932.
- Wang, C., X.Y. Li, C. Jiang, S. Tang and Y. Liu, 2011. Multicast throughput for hybrid wireless networks under gaussian channel model. *IEEE Trans. Mob. Comput.*, 10: 839-852.
- Yang, S., C.K. Yeo and B.S. Lee, 2012. Toward reliable data delivery for highly dynamic mobile ad hoc networks. *IEEE Trans. Mobile Comput.*, 11: 111-124.
- Yi, J., C. Poellabauer, X.S. Hu and L. Zhang, 2011. Minimum bandwidth reservations for periodic streams in wireless real-time systems. *IEEE. Trans. Mobile Comput.*, 10: 479-490.