

## High Speed Switching for Li-Fi Backbone

<sup>1</sup>Seyed Mehdi Mousavi, <sup>2</sup>Ahmad Khademzadeh and <sup>2</sup>Human Zarrabi

<sup>1</sup>Payame Noor University, Tehran, Iran

<sup>2</sup>Iran ICT Research Center, Tehran, Iran

---

**Abstract:** Now a days almost all the peoples are using internet to do their task through wired or wireless network. Though Wi-Fi gives us speed up to 150 Mbps as per IEEE 802.11n which is not sufficient to service number of desired users. To solve this problem of Wi-Fi, the new concept of Li-Fi technology is introduced. Li-Fi stands for the light fidelity by sending data through an LED light bulb that varies in intensity faster than the human eye can follow. It's the same idea behind infrared remote controls but far more powerful. can produce data rates faster than 10 Mbps. With this huge bandwidth preparation of Li-Fi, there is a propose in the insertion of optically interconnected networks with high-radix transparent optical switch fabrics. Silicon photonics is a particularly promising and applicable technology due to its small footprint, CMOS compatibility, high bandwidth density and the potential for nanosecond scale dynamic connectivity. In this study, shown the feasibility of building silicon photonic microring based switch fabrics for Li-Fi optical interconnection networks that can use a microring based switch fabric for WDM signals with this idea Li-Fi performance will improve by increasing switching speed over the backbone of the network. Also other researcher work on the applicability of silicon photonic microrings for data center switching and supercomputers that we need high speed switching.

**Key words:** Li-Fi, VLC, optical wireless, silicon photonic switch fabric, introduced, CMOS compatibility, Iran

### INTRODUCTION

The statistics of ITU said that the use of mobile and internet is increased, so that there is around 11 Exabyte (10<sup>18</sup>) of data transferred through mobile networks due to increase in various communication systems there is no doubt of electromagnetic spectrum band gets occupied within a few next tens of decades.

Over the past decade, significant research efforts have been directed towards exploring alternative parts of the electromagnetic spectrum that could potentially offload a large portion of the network traffic from the overcrowded RF domain. The Li-Fi brings the best solution over these all problem which uses Visible Light Communication (VLC) (Glick *et al.*, 2013).

Li-Fi stands for Light-Fidelity. Li-Fi is transmission of data through illumination by taking the fiber out of fiber optics by sending data through an LED light bulb that varies in intensity faster than the human eye can follow. Li-Fi is the term some have used to label the fast and cheap wireless communication system which is the optical version of Wi-Fi. Li-Fi uses visible light instead of Gigahertz radio waves for data transfer that can be used to produce data rates higher then 10 Gbp sec which is much faster than our average broadband connection.

Li-Fi offers much larger frequency band (300 THz) compared to that available in RF communications (300 GHz). Also, more data coming through the visible spectrum could help alleviate concerns that the electromagnetic waves that come with Wi-Fi could adversely affect our health. Li-Fi can be the technology for the future where data for laptops, smart phones and tablets will be transmitted through the light in a room. Security would not be an issue because if you can't see the light, you can't access the data. As a result, it can be used in high security military areas where RF communication is prone to eavesdropping.

Current wireless network coverage many users that require a large and efficient bandwidth and high speed interconnection network. The main challenge is providing a fast and non-blocking switching platform that is low cost, energy efficient and supports large-scale topologies (Nikolova *et al.*, 2015). In conventional intra Li-Fi networks, electronic packet switching is used as the switching substrate. Conventional electronic switching and interconnection network platforms operate with significant power consumption that grows with data rates.

Optical Wavelength Division Multiplexing (WDM) provides terabit data transmission and optical switching can fundamentally provide fast and low energy

switching functionalities for intra Li-Fi networks. Optical Point-to-Point (P2P) links are extensively used in current Li-Fi network for uplink connectivity. However utilizing optical links for P2P data transmission requires Optical-to-Electrical (O/E) and Electrical-to-Optical (E/O) conversions at each node as switching is still performed in the electrical domain (Shabani *et al.*, 2016).

Hybrid architectures have been proposed that simultaneously interconnect nodes with optical circuit switching and electrical packet switching. Silicon photonics is an excellent candidate technology for realizing such ultra-high speed optical switches. It provides small area footprint, low power consumption and the potential for reduced fabrication costs at large scales (Hendry *et al.*, 2010). Silicon photonic switches have received significant research interest in the past several years for realizing intra-chip and intra-node interconnects as well as inter-node interconnects for data centers or supercomputers. Integrated optical switching can be performed with various device configurations including Mach-Zehnder (MZ) interferometers, 2D MEMS and microrings.

## MATERIALS AND METHODS

**Construction of Li-Fi system:** Li-Fi is a fast and cheap optical version of Wi-Fi. It is based on Visible Light Communication (VLC). VLC is a data communication medium which uses visible light between 400 THz (780 nm) and 800 THz (375 nm) as optical carrier for data transmission and illumination. It uses fast pulses of light to transmit information wirelessly. The main components of Li-Fi system are a high brightness white LED which acts as transmission source and a silicon photodiode with good response to visible light as the receiving element (Fig. 1). LEDs can be switched on and off to generate digital strings of different combination of 1sec and 0sec. To generate a new data stream, data can be encoded in the light by varying the flickering rate of the LED. The LEDs can be used as a sender or source by modulating the LED light with the data signal. The LED output appears constant to the human eye by virtue of the fast flickering rate of the LED. Communication rate >100 Mbps is possible by using high speed LEDs with the help

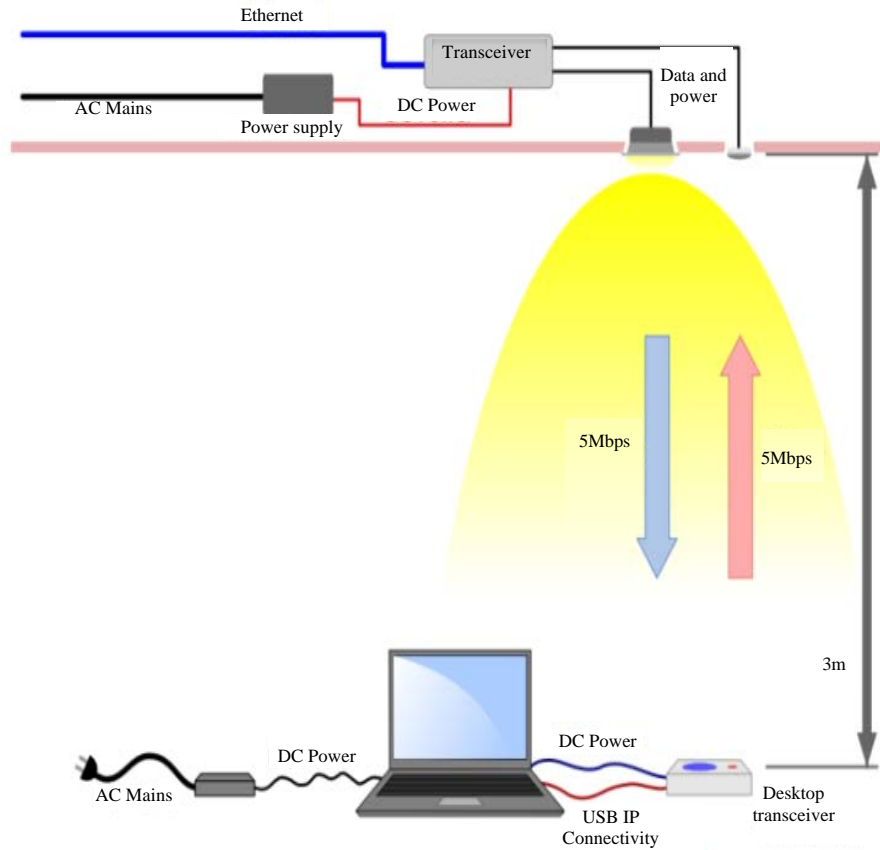

Fig. 1: Working principle of Li-Fi technology

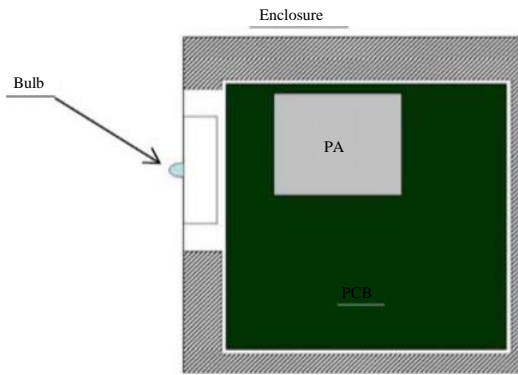

Fig. 2: Block diagram of Li-Fi sub-assembly

of various multiplexing techniques. VLC data rate can be increased by parallel data transmission using an array of LEDs where each LED transmits a different data stream. The Li-Fi emitter system consists of 4 primary subassemblies: bulb, RF Power Amplifier circuit (PA), Printed Circuit Board (PCB) and enclosure. The PCB controls the electrical inputs and outputs of the lamp and houses the microcontroller used to manage different lamp functions. A RF (Radio-Frequency) signal is generated by the solid-state PA and is guided into an electric field about the bulb. The high concentration of energy in the electric field vaporizes the contents of the bulb to a plasma state at the bulb's center; this controlled plasma generates an intense source of light. All of these subassemblies (Fig. 2) are contained in an aluminum enclosure.

The LED is connected to the internet through the modem and the receiver decodes the information which is then displayed on the device. When a constant current is applied to an LED light bulb a constant stream of photons are emitted from the bulb which is observed as visible light. If the current is varied slowly the output intensity of the light dims up and down. Because LED bulbs are semi-conductor devices, the current and hence the optical output, can be modulated at extremely high speeds which can be detected by a photo-detector device and converted back to electrical current. If we have multiple Li-Fi APs in a room, we need to connect every optical Ethernet link to a high speed optical switch that it can connect to other high speed optical switch and make a big network with wide coverage (Fig. 3).

By using silicon photonic switch fabrics for Li-Fi nodes interconnection, we have a solution toward all-optical network with high performance and high speed and a low consumption power (Vijaykumar, 2015).

**Silicon photonic microrings based 2x2 switch:** The basic 2x2 switching element, schematically drawn in Fig. 4, consists of two silicon microring resonators and

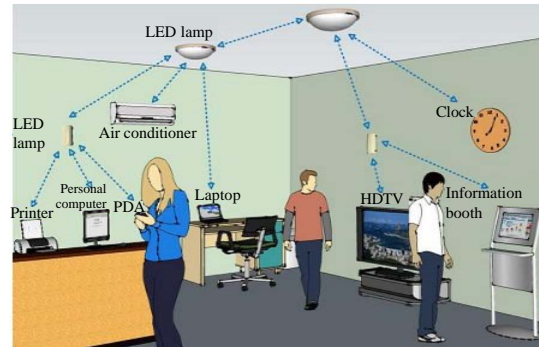

Fig. 3: Li-Fi system connecting devices in a room

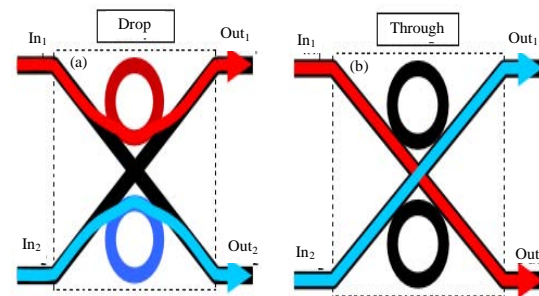

Fig. 4: The 2x2 switching element in: a) "drop" and b) "through" state

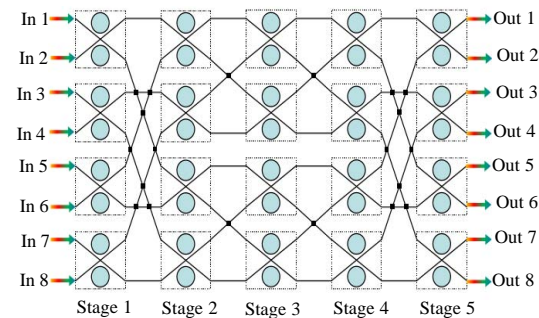

Fig. 5: The 8-by-8 multistage switch with benes topology

two crossing silicon waveguides. When the rings are ON resonance with an input signal this signal is coupled to the ring then coupled back to the second waveguide. In this way, the signal is "dropped" onto the other waveguide as shown in Fig. 4a. When the rings are OFF resonance, the signal passes through the switching element remaining on the same waveguide as shown in Fig. 4b. Both input signals can be dropped into or allowed to pass by the rings simultaneously which allows this type of switch to be used as a full 2x2 switching element for composing more complex switch architectures (Sharma and Sanagal, 2014) (Fig. 5).

In order to create higher radix switching fabrics, multiple  $2 \times 2$  switching elements can be interconnected in stages. To form a reconfigurable non-blocking switching fabric, we consider the basic switching elements interconnected in Benes network. Hence a switching fabric with  $N$  input and  $N$  output ports has  $\log_2 N - 1$  stages each consisting of  $N/2$  switches as shown on Fig. 5. The interconnection of these  $N \log_2 N - N/2$  switching elements translates into waveguide crossings, provided that all waveguides located on the same chip share the same plane. A particular attention must be paid to these crossings as they both attenuate and generate crosstalk (Dobroslav *et al.*, 2015).

### RESULTS AND DISCUSSION

**Silicon photonic switch fabrics control and Li-Fi network integration:** Integrating nanophotonic switch fabrics in network switches requires implementing mechanisms for arbitration, actuation control and in the case of microrings, thermal stabilization. Mechanisms for thermal stabilization using control systems have been developed and demonstrated. Control signals can be generated in reaction to some monitoring of the individual element. Ongoing research efforts aim at generating microring control signals using FPGAs coupled to high-speed Analog-to-Digital (ADC) and Digital-to-Analog (DAC) devices, based on generation of errors signals. In more advanced prototypes, FPGAs can be replaced by Application-Specific Integrated Circuits (ASICs). This will allow further decreasing of the energy footprint of

required electrical arbitration logic. Additionally, it has been shown that optimized photonic circuits can be designed such that their fundamental operating states can be switched with an inverter, providing a low-power system solution. The overall mechanism for silicon photonic switch fabric control consists of establishing a switch arbitration plan, according to which actuation signals will be generated. If this plan is locally defined, a switch controller exchanging control messages with (or simply receiving from) the optical network clients must be developed (Poonam and Siddiqui, 2014). A protocol through which network clients announce their communication needs and are informed of the optical network availabilities also must be defined. Alternatively, network-wide arbitration can be realized by an independent component, potentially in charge of multiple switch fabrics.

A combined broadband switching and oriented control architecture is depicted in Fig. 6. It shows how a silicon photonic switch receives its commands and can be controlled via an electrical network interface connected to digital logic devices. Using the appropriate electrical driving mechanisms for the optics these devices achieve the system level configuration. The electrical network interface typically receives instructions and commands from the currently deployed data center software application. Such an architectural approach is necessary for implementing high-radix silicon photonic microring switching devices in Li-Fi backbone interconnection networks (Rani *et al.*, 2012).

The ring resonator can be configured to be used as a Photonic Switching Element (PSE) as shown in Fig. 7. By

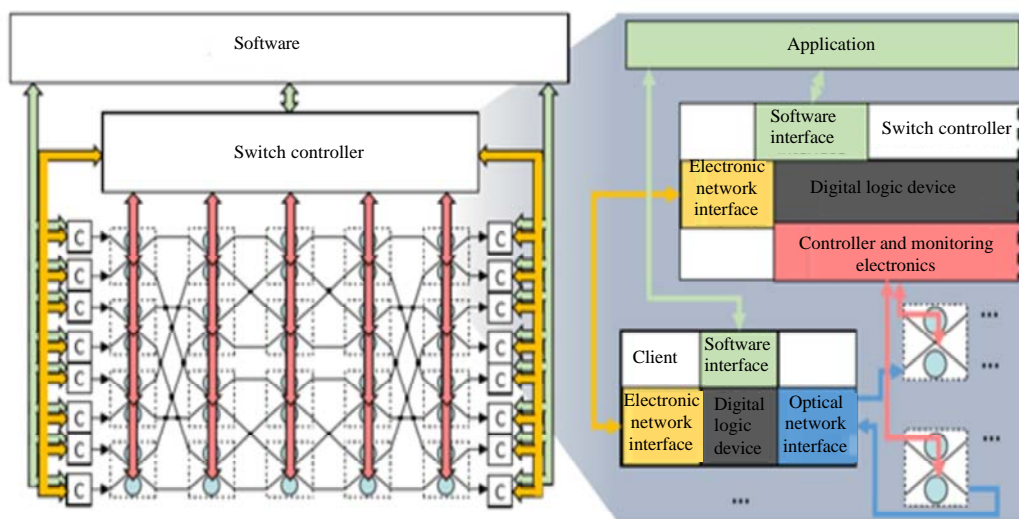

Fig. 6: Silicon photonic computing architecture applicable to Li-Fi backbone network

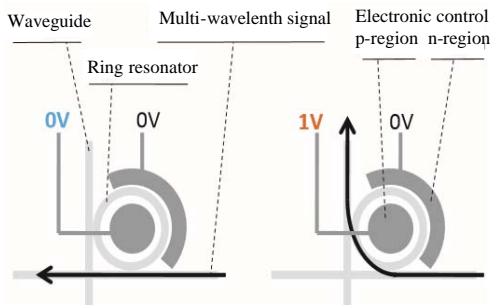

Fig. 7: Operation of PSE. Left-PSE in off state. Right-PSE in on state

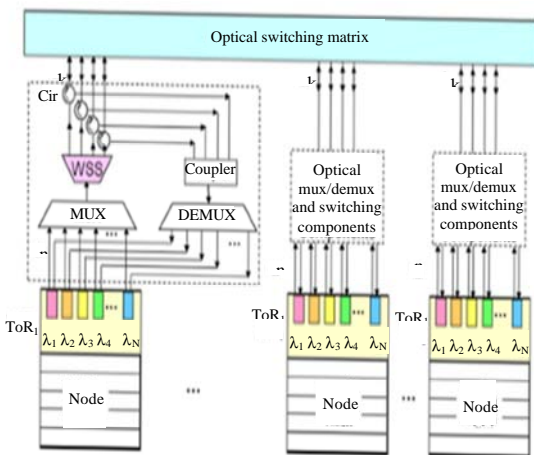

Fig. 8: Network topology for Li-Fi nodes interconnection

electrically injecting carriers into the ring, the entire resonant profile is shifted, effectively creating a spatial switch between the ports of the device. This process is analogous to setting the control signals of an electronic crossbar. Given the operation of a single PSE, we can then construct higher order switches and ultimately entire networks. Using ring-resonator devices in this way opens the possibility to explore different network topologies in much the same way as packet-switched electronic networks. Different numbers and configurations of ring switches yield different amounts of energy, different path-blocking characteristics as well as varying insertion loss. illustrating the potential for vastly higher bandwidth density that is offered by using photonic waveguides when using WDM.

**Network topology:** For connecting Li-Fi nodes to optical switching matrix, we can configure network topology as shown in Fig. 8. In optical switch matrix that we use silicon photonic switch, some famous topologies for example mesh, torus, fat-tree can be used on the circuit switching way and XY routing model.

## CONCLUSION

The confidence brought by encouraging recent research results and by the successful VLC link-level demonstrations, has now shifted the focus towards an entire Li-Fi attocell networking solution. The unique physical properties of light promise to deliver very densely-packed high-speed network connections resulting in orders of magnitude improved user data rates. Based on these very promising results, it seems that Li-Fi is rapidly emerging as a powerful wireless networking solution to the looming RF spectrum crisis and an enabling technology for the future internet-of-everything. Based on past experience that the number of wireless applications increases by the square of the number of available physical connections, Li-Fi could be at the heart of an entire new industry for the next wave of wireless communications.

High-port count photonic switch fabrics that can be dynamically configured at nanosecond rates are essential for reducing network latency and increasing high-bandwidth connectivity in Li-Fi backbone interconnection network. Silicon photonics with its CMOS compatibility and dense WDM capabilities is an excellent candidate technology for their realization.

We proposed a way how the silicon photonic switching fabric can be controlled, managed and hence fully integrated into an optically interconnected Li-Fi system design. The silicon photonic platform is capable of offering energy efficient, scalable high-radix integrated switching fabrics.

## RECOMMENDATIONS

In future we can perform experimental network with LWSim (Light Weight Sim) which focuses on the traffic dynamics of the network only at simulation time but incorporates the parameterized models for photonics devices of PhoenixSim at the model construction. More generally, we believe that rather than integrating all the possible models into one simulator, a preferable method consists in having a suite of simulators, each one focusing on a given time scale, level of detail and/or metric of interest.

## REFERENCES

Dobroslav, T., V. Stefan and H. Harald, 2015. Light Fidelity (Li-Fi): Towards All-Optical Networking. The University of Edinburgh, Edinburgh, Scotland, UK.

- Glick, M., S. Rumley, G. Dongaonkar, Q. Li and K. Bergman *et al.*, 2013. Silicon photonic interconnection networks for data centers. Proceedings of the Conference on Photonics Society Summer Topical Meeting Series, July 8-10, 2013, IEEE, Waikoloa, Hawaii, USA, ISBN:978-1-4673-5060-0, pp: 244-245.
- Hendry, G., E. Robinson, V. Gleyzer, J. Chan and L. Carloni *et al.*, 2010. Circuit-switched memory access in photonic interconnection networks for high-performance embedded computing. Proceedings of the 2010 ACM/IEEE International Conference on High Performance Computing, Networking, Storage and Analysis, November 13-19, 2010, IEEE, Washington, DC., USA., ISBN:978-1-4244-7559-9, pp: 1-12.
- Nikolova, D., S. Rumley, D. Calhoun, Q. Li and R. Hendry *et al.*, 2015. Scaling silicon photonic switch fabrics for data center interconnection networks. *Opt. Express*, 23: 1159-1175.
- Poonam, V.P. and M.S. Siddiqui, 2014. Li-Fi technology. *Intl. J. Comput. Sci. Inf. Technol.*, 5: 8031-8032.
- Rani, J., P. Chauhan and R. Tripathi, 2012. Li-Fi (Light Fidelity)-the future technology in wireless communication. *Intl. J. Appl. Eng. Res.*, 7: 258-262.
- Shabani, H., A. Roohi, A. Reza, M. Reshadi and N. Bagherzadeh *et al.*, 2016. Loss-aware switch design and non-blocking detection algorithm for intra-chip scale photonic interconnection networks. *IEEE. Trans. Comput.*, 65: 1789-1801.
- Sharma, R.R. and A. Sanganal, 2014. Li-Fi technology: Transmission of data through light. *Intl. J. Comput. Technol. Appl.*, 5: 150-154.
- Vijaykumar, N.S., 2015. Li-fi (Light Fidelity)-the changing scenario of wireless communication. *Intl. J. Res. Eng. Technol.*, 4: 435-438.