

## Head Gesture and Voice Control Wheel Chair System using Signal Processing

R. Sathish Kumar and M.G. Abdulla

*Department of Computer Science and Engineering, Manakula Vinayagar Institute of Technology, Pondicherry, India*

**Key words:** MEMS, head gesture, voice control, disabled folks, AT89S52

**Abstract:** This project could be a improved style of mechanically controlled chair that is exactly supposed for the folks with frailness. This device assistances the operators to transfer from one place to the opposite empty the support of others. The puzzling troublesome encountered by the paralytic persons is their self-acting movement. They have associate external facilitate to attain their every day accomplishments. powered wheelchairs square measure aimed to assist paraplegics unsuitably, these cannot be utilized by persons with higher degree of deficiency, like quadriplegics, i.e., persons that, thanks to age or illness, cannot move any of the body elements, except of the pinnacle. The key objective of the project is to afford associate automatic system for disabled folks. The wheel chair can labor supported the pinnacle live of the user. the quality gestures square measure accustomed turn out motion management tips to the management in order that it will control the motion of the wheel chair in step with the user intention. Proposal and growth of head motion controlled chair has been earned exploitation measuring system sensors and AT89S52 microcontroller. The system is instigated just about and works well. The measuring system device senses the amendment in direction of head and consequently the signal is given to microcontroller. betting on the direction of the Acceleration, microcontroller controls the wheel chair directions like left, right, front and back with the help of DC motors. The wheel chair is additionally controlled by voice recognition of the users through Bluetooth signal exploitation portable. Be contingent the voice signal, the microcontroller controls the track of the wheel chair.

### Corresponding Author:

R. Sathish Kumar

*Department of Computer Science and Engineering, Manakula Vinayagar Institute of Technology, Pondicherry, India*

Page No.: 207-215

Volume: 18, Issue 8, 2019

ISSN: 1682-3915

Asian Journal of Information Technology

Copy Right: Medwell Publications

## INTRODUCTION

An combined approach to tangible discovery, chasing and track feeling of hands unreal to be used as a human-robot in interface is inventively adopted for the intelligent chair. Accelerometers are accustomed meritoriously translate head motion into computer construed signals. For motion recognition the measuring

system info is standardized and filtered. The accelerometers live the magnitude and track of gravity to boot to enterprise induced acceleration. We've got an inclination to rotate the device "delicate axis with relevancy gravity and use the resultant signal as associate absolute dimension. Act one chip wireless elucidation with a MEMS accelerometer (Pajkanovic and Dokic, 2013) desired yields associate autonomous device

sufficiently little to use to the fingernails, thanks to the smaller size and weight. Accelerometers are dedicated to the receiver. Arrows on the receiver show the location of accelerometers and their refined directions. The sensitive direction of the measuring system is at intervals the plane of the top. The motion based chair is suitable for the aged or the physically challenged folks that are sadly lost the facility of their limbs thanks to this function or by birth or by adulthood. Elders understand it powerful to maneuver within the house for day to day activities whereas not facilitate or external aid. Our projected system makes use of a chair which can be utilized by aged or physically challenged to maneuver at intervals the house with none issue and with none external aid (Veeraiah *et al.*, 2013; Pajkanovic and Dokic, 2013). The physically challenged, understand it robust to maneuver the wheel chair with none facilitate. By making use of the system, the aged and conjointly the physically, challenged can move at intervals the house by merely showing a gesture that's predefined to the particular space. It's together a virtue of the system that even the foot are going to be substituted in place of the hand for users world health organization might understand it further convenient. The aim of this innovation is to dominant a wheel chair and electrical devices by practice MEMS measuring system detector (micro electro-mechanical systems) technology. MEMS measuring system detector might be a tiny low robot detector that's terribly sensitive and capable of detection the lean. This detector transforms the lean and makes use of the measuring system to vary the direction of the wheel chair count on motion of head. If the lean is to the right side then the wheel chair moves in right direction or if the lean is to the left aspect then the wheel chair moves in left direction (Kalantri and Chitre, 2013). Wheel chair movement are going to be controlled in forward, reverse and left and Right directions excluding obstacle detection practice quiet detector. Automation is that the foremost typically spelled term at intervals the sphere of physics. The hunger for automation brought many revolutions at intervals the present technologies. One in each of the technologies that had larger developments is that the MEMS measuring system detector. They have bigger importance than the opposite technologies due its straightforward nature. MEMS measuring system detector based devices can be simply adopted to their easier operation.

**Literature review:** When associate unfortunate event affects the motor quality of somebody, it is necessary to use devices like wheelchairs that provide a approach of movement for patients with drawback of moving the lower limbs (Bhuiyan and Picking, 2011). Tremendous developments square measure created at intervals the field of chair technology. However, even these important advances haven't been able to facilitate quadriplegics

navigate chair unassisted. Some patients UN agency cannot manipulate the chair with their arms due to lack of force or completely different problems at intervals the bounds can operate this kind of electrical wheelchairs, manipulated with head motion (Veeraiah *et al.*, 2013). The movement of a chair is controlled by head motion. The advances area unit created by the idea of the management package victimization an measuring instrument and some distances and mechanism sensors controlled by a PIC microcontroller that establishes the communication with a program developed in workplace scan. Sensible wheelchairs will keep a fertile ground for technological analysis for many years to come back (Gray *et al.*, 2007). Smart wheelchairs area unit wonderful take a glance at beds for device analysis, notably machine vision. smart wheelchairs together provide an opportunity to ascertain human-robot interaction, accommodative or shared management and novel input ways in which like voice management, EOG and eye-tracking. What's a lot of smart wheelchairs will still operate take a glance at beds for golem management design.

**Movement primarily based chair management for physically challenged:** Various ways are projected for permitting disabled persons, together with a handicapped person to manage a wheelchair.

There square measure projected methodologies in recent times that involve varied gestures like hand gesture, measuring system and voice controlled, graphical record primarily based system, etc.

**Motion recognitions:** Motion recognition could be a method during which a receiver acknowledges user's motion. During this context, motions square measure expressional movements of build elements such as: fingers, hands, arms, head, face, legs. The aim of those movements will be info transfer or the interaction with the environments.

**Measuring system and voice controlled:** This research describes a chair for physically disabled folks its exploitation voice recognition kit and MEMS motion device. User dependent voice recognition system had been integrated within the chair. During this approach a chair will be driven exploitation each motion and voice commands (Mazo, 2001).

**Hand movements primarily based management of associate intelligent wheelchair:** Physically challenged folks, UN agency needs to maneuver around with the assistance of some artificial suggests that is unceasingly increasing. Driving a chair in domestic environments could be a troublesome task for a standard person and becomes even tougher for folks with arms or hands impairments. Use of measuring system, inaudible and infrared device systems square measure properly

integrated during this chair (Iturrate *et al.*, 2009). A pre-fabricated wheel chair will be driven exploitation measuring system and with the chance of avoiding obstacles exploitation IR device and downstairs or hole detection exploitation inaudible device. Supposed users management the system by sporting a glove fitted with measuring system for dominant the movement and direction of the chair. The MEMS device senses the angle of the hand, i.e. in step with the lean of hand it provides voltages to microcontroller the most advantage of this chair is low value, low power consumption and simple to control by the physically challenged folks.

## MATERIALS AND METHODS

### Hardware style details

#### A. AT89S52 microcontroller

##### Features:

- Compatible with MCS(R)-51 product
- 8K Bytes of In-System Programmable (ISP) nonvolatile storage-Endurance: one thousand write/erase cycles
- 4.0-5.5V operational vary
- Fully static operation: zero hertz to thirty three mega-hertz. Three-level program memory lock
- 256×8-bit Internal RAM
- 32 programmable I/O lines
- Three 16-bit timer/counters
- Eight interrupt sources
- Full duplex UART serial channel
- Low-power idle and power-down modes
- Interrupt recovery from power-down mode
- Watchdog timer
- Dual information pointer

**Description:** The AT89S52 could be a low-power, superior CMOS 8-bit microcontroller with 8K bytes of in-system programmable nonvolatile storage. The device is factory-made exploitation Atmel's high-density non-volatile memory technology and is compatible with the indus-try-standard 80C51 instruction set and pin out. The on-chip flash permits the program memory to be reprogrammed in-system or by a standard non-volatile memory pro-grammars. By combining a flexible 8-bit central processing unit with in-system programmable Flash on a monolithic chip, Fig. 1 Atmel AT89S52 could be a powerful microcontroller that provides a highly-flexible and cost-efficient resolution to several embedded management applications (Seki *et al.*, 2000). The AT89S52 provides the subsequent customary features: 8K bytes of flash, 256 bytes of RAM, 32 I/O lines, Watchdog timer, 2 information pointers, 3 16-bit timer/counters, a six-vector two-level interrupt design, a full duplex port on-chip generator and clock electronic

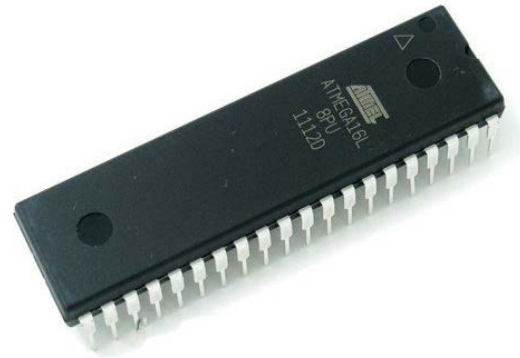

Fig. 1: At89s52 microcontroller

equipment. Additionally, the AT89S52 is intended with static logic for operation all the way down to zero frequency and supports 2 code selectable power saving modes. The idle mode stops the central processing unit whereas permitting the RAM, timer/counters, port and interrupt system to continue functioning. The power-down mode saves the RAM contents however freezes the generator, disabling all different chip functions till succeeding interrupt or hardware reset (Pajkanovic and Dokic, 2013).

**Power supply:** Power provide could be a regard to a supply of power. a tool or system that provides electrical or different forms of energy to associate output load or cluster of hundreds is named an influence provide unit or PSU as shown in Fig. 2. The term is most ordinarily applied to electricity provides, less typically to mechanical ones and infrequently to others (Gangopadhy *et al.*, 2013).

A 230V, 50 Hz single part AC power provide is given to a step down electrical device to urge 12V provide (Kumar and Pariselvam, 2012). This voltage is regenerate to DC voltage employing a bridge rectifier. The regenerate beating DC voltage is filtered by a 2200 uf electrical device then given to 7805 transformer to get constant 5V provide. This 5V provide is given to all or any the parts within the circuit. A RC time constant circuit is additional to discharge all the capacitors quickly to confirm the facility provide a junction rectifier is connected for indication purpose.

**Bridge rectifier:** A bridge rectifier makes use of 4 diodes in a very bridge arrangement to attain full-wave rectification as shown in Fig. 3. This can be a wide used configuration, each with individual diodes wired as shown and with single part bridges wherever the diode bridge is wired internally (Ding *et al.*, 2007).

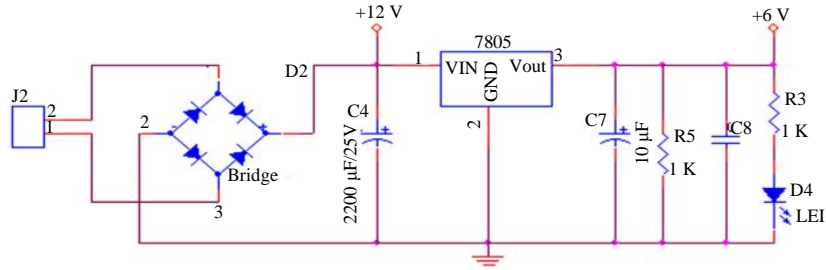

Fig 2: Power provider

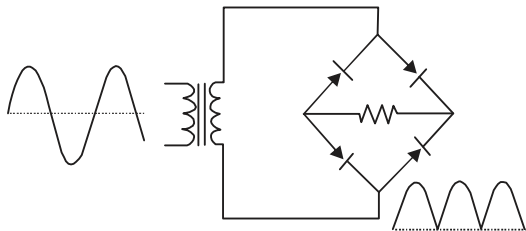

Fig. 3: Circuit of bridge rectifier LM7805: 3-Terminal 1A positive transformer

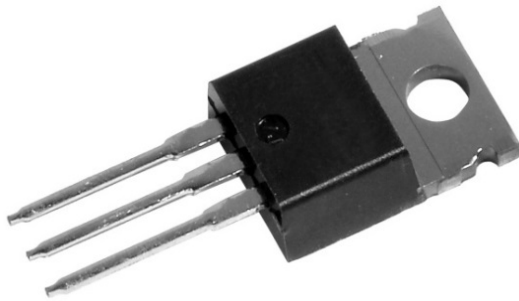

Fig. 4: Diagram of transformer

**Features:**

- Output current up to 1A
- Output voltages of five, 6, 8, 9, 10, 12, 15, 18, 24V
- Thermal overload protection
- Short circuit protection
- Output electronic transistor safe operational space protection

**Description:** The KA78XX/KA78XXA series of three-terminal positive regulator square wave accessible within the TO-220/D-PAK package and with many fastened output voltages, creating them helpful in a very big selection of applications. every sort employs internal current limiting, thermal stop working and safe operational space protection, creating it primarily indestructible (Kalantri and Chitre, 2013). If adequate heat sinking is provided, they'll deliver over 1A output

current. though designed primarily as fastened voltage regulators, these devices will be used with external parts to get adjustable voltages and currents (Fig. 4 and 5).

**Relay:** A relay is associate electrically operated switch. several relays use associate magnet to automatically operate a switch, however different operational principles also are used like solid state relays as shown in Fig. 6. Relays square measure used wherever it's necessary to manage a circuit by a separate low-power signal or wherever many circuits should be controlled by one signal.

**Relay locations:** Relays square measure placed throughout the complete vehicle. Relay blocks, each giant and tiny, square measure placed within the engine compartment; behind the left or right kick panels or below the dash square measure common locations. Relays square measure typically sorted along or with different parts like fuses or placed by themselves (Srishti and Jain, 2015).

**Relay operation:** All relays operate exploitation identical bedrock. Our example can use a unremarkably used four pin relay. Relays have 2 circuits as shown Fig. 7. An impression circuit (shown in green) and a load circuit (shown in red) (Ding *et al.*, 2007). The feedback circuit encompasses a little management coil whereas the load circuit encompasses a switch. The coil controls the operation of the switch.

**Relay energized (on):** Current flowing through the feedback circuit coil pins one and three creates a tiny low flux that causes the switch to shut, pins a pair of and four. The switch that is a component is associate element of the load circuit is employed to manage an electric circuit that will connect with it as shown in Fig. 8. Current currently flows through pins a pair of and four shown in RED, once the relay in energized (Katevas *et al.*, 1997).

**Ultrasonic sensor:** Associate ultrasonic sensor device could be a device that may live the space to associate object by exploitation sound waves. It measures distance

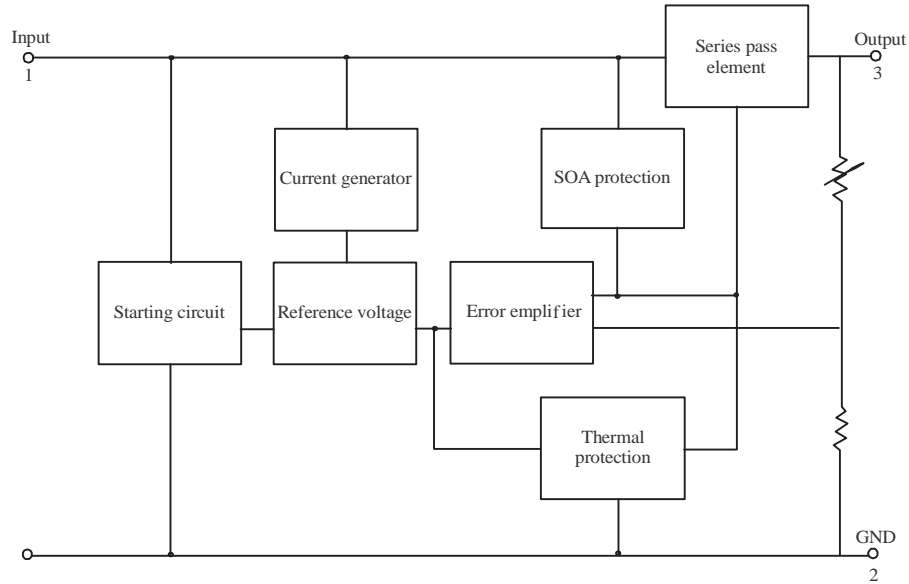

Fig. 5: Diagram of transformer



Fig. 6: Relays

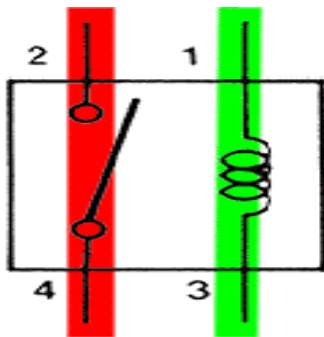

Fig. 7: Relay operation

by causing out a wave at a selected frequency and listening for that wave to make a comeback. By recording the period between the wave being generated and therefore the wave bouncing back as shown in Fig. 9, it's do able to calculate the space between the measuring instrument device and therefore, the object.

Fig. 8: Relay energized

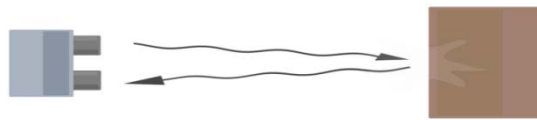

Fig. 9: Ultrasonic sensor operation

It is vital to grasp that some objects may not be detected by inaudible sensors. this can be as a result of some objects square measure formed or positioned in such the way that the wave bounces off the item, however, square measure deflected aloof from the inaudible device. It's conjointly doable for the item to be too little to replicate enough of the wave back to the device to be detected.

Other objects will absorb the wave all at once (cloth, carpeting, etc.) which implies that there's no approach for the device to discover them accurately. These square measure vital factors to think about once planning associated programming a mechanism exploitation an inaudible device (Landi, 2003).

Table 1: Electrical parameters

Parameters	Power supply
Operating voltage	DC 5 V
Operating current	15 mA
Operating frequency	40 Hz
Scoop vary	4 m
Min vary	2 cm
Mensuration angle	15°
Trigger signaling	10 μS TTL pulse
Echo signal	Input TTL lever signal and the range in proportion
Dimension	45*20*15 mm

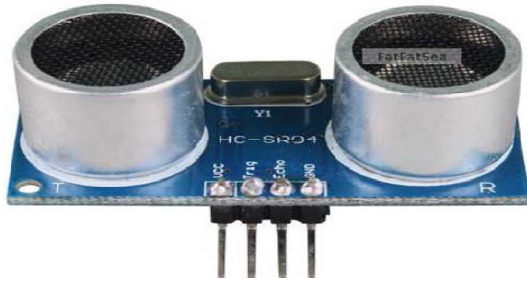

Fig. 10: Ultrasonic device

**Formula to calculate distance:**

$$\text{Distance} = \frac{\text{Speed of sound} \times \text{time taken}}{2}$$

**Product features:** Inaudible go module HC-SR04 provides 2-400 cm non contact activity operate, the go accuracy will reach to 3 mm. The modules includes inaudible transmitters, receiver and feedback circuit shown in Fig. 10. The basic principle of work (Table 1):

- Exploitation IO trigger for a minimum of 10 usec high level signal
- The module mechanically sends eight forty rate and discover whether or not there’s a pulse signal back
- IF the signal back, through high level, time of high output IO period is that the time from causing inaudible to returning

**Electric parameter**

**Design and drawings**

**Hardware requirements:**

- Microcontroller (AT89S52)
- MEMS
- Relay
- Ultrasonic device
- ADC
- Servo motor

**Software requirements:**

- EMBEDDED C
- KEIL Compiler



Fig. 11: Style model

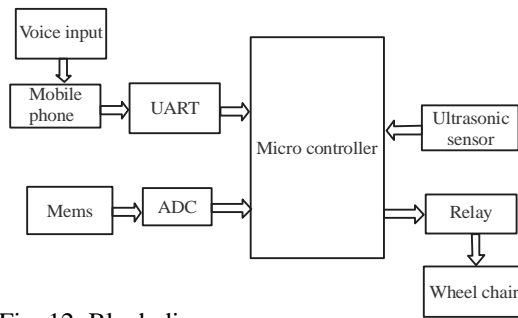

Fig. 12: Block diagram

**Design model**

**Block diagram**

**Working principle**

**Obstacle-recognition algorithm:** Since, a collection of doable motions during this case is incredibly little, the amount of accessible commands is additionally terribly restricted as shown in Fig. 11-17. Thus, the system that we tend to propose permits the user to convey solely four completely different commands: “forward”, “backward”, “left” and “right” (Bourhis *et al.*, 2001). This implies that the set of motions to be recognized has solely four members. The enforced algorithmic program depends greatly on this truth. The that means of every of the commands is relative and depends on this chair state.

Namely, we tend to outline six completely different chair states: “state of still”, “moving forward - first gear”, “moving forward -2d gear”, “moving backward”, “rotating left” and “rotating right”. If the chair is within the “state of still”, the command “forward” can place it within the state “moving forward first gear” and therefore, the command “backward” can place it within the state “moving backward”. On the opposite hand, if the chair is within the state “moving forward first gear”, the command “forward” can place it within the state “moving forward-2d gear” and therefore, the command” backward

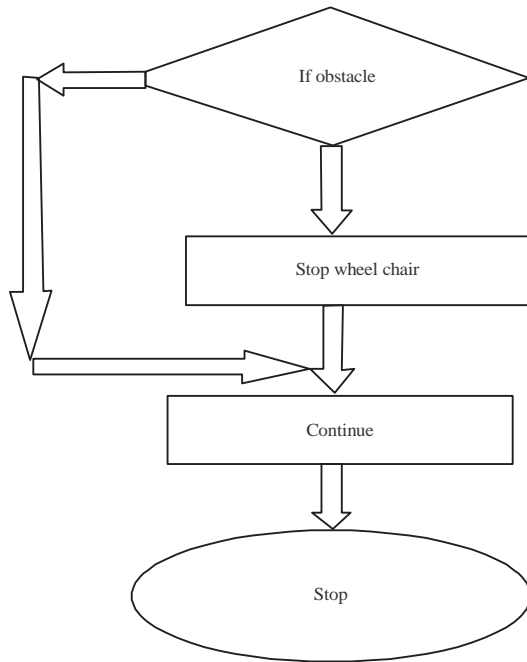

Fig. 13: Ultrasonic recognition algorithm



Fig. 14: At traditional position

can place it within the state “state of still”, i.e., stop the chair. Analogously, if the chair is within the state “moving backward”, the command “forward” can stop it (Lankenau and Rofer, 2001; Srishti and Jain, 2015).

**Voice recognition:** The main objective is to style a system that provides resolution for the physically disabled (challenged) folks those that cannot move by themselves. Exploitation speech commands by interfacing the Speech Recognition kit (HM2007) with microcontroller and wheel chair. The Mic is provided to the person sitting on the wheel chair. HM2007 speech recognition kit registers the commands and forward them to the microcontroller. Microcontroller takes the commands from speech

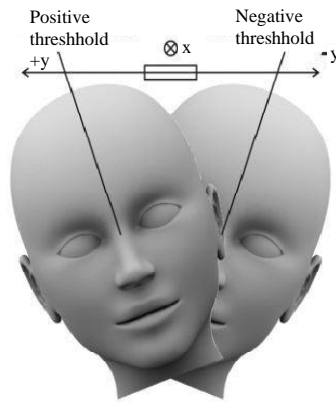

Fig. 15: At left and right movement

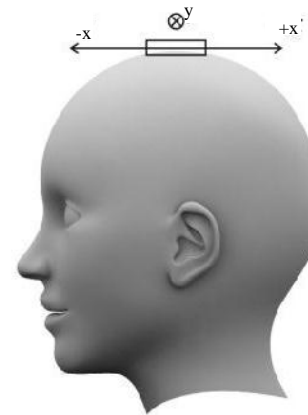

Fig. 16: Negative and positive

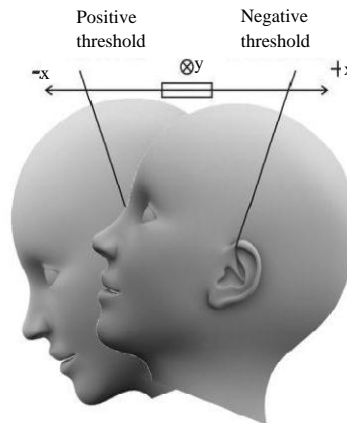

Fig. 17: At forward and threshold backward

recognition kit and passes them to the motor drivers. Motor driver receives the commands from microcontroller P89V51RD2BN and moves the motors in step with them. The motors square measure connected to the wheels of the chair (Lankenau and Rofer, 2001).

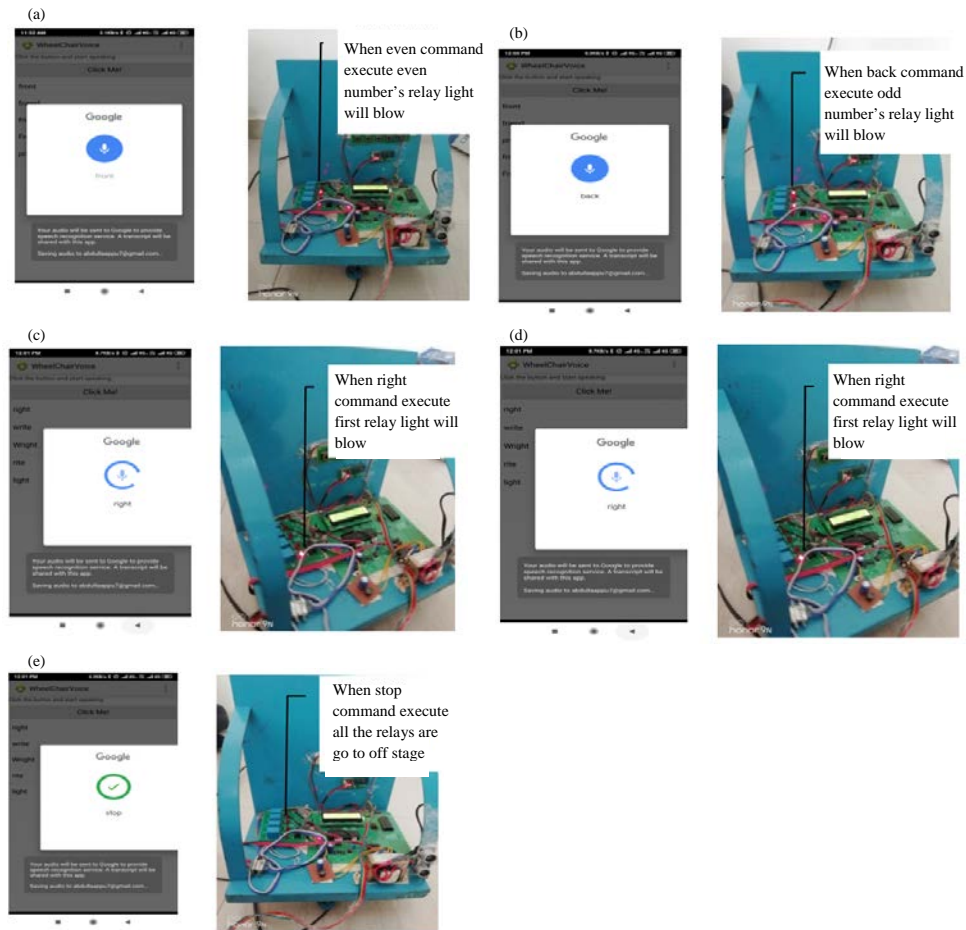

Fig. 18 (a-e): Worth for passes by MEMS, (a) Front command, (b) Back command, (c) Right command, (d) Left command and (e) Right command

**Algorithm steps:**

- The operating will be explained within the following steps:
- Step 1: At the start 5V power provide is given to the HM2007 speech recognition kit, P89V51RD2 microcontroller and motor drivers
- Step 2: Voice module is prepared to receive the commands
- Step 3: If the given voice command is LEFT then the wheel chair moves left facet
- Step 4: If the command is true the wheel chair moves right facet
- Step 5: If the command is FORWARD the wheel chair moves forward
- Step 6: If the command is BACKWARD the wheel chair moves backward
- Step 7: If the command is STOP the chair stops moving

**Head motion recognition:** This robotic wheel chair permits the patient to own an impression over four completely different directions specifically the forward, backward as shown in Fig. 14 and 15, right and left as shown in Fig. 16-18 (Pajkanovic and Dokic, 2013).

An measuring system is associate integrated device that measures correct acceleration, the acceleration experience relative to free fall. Single and multi axis models square measure accessible to discover magnitude

and direction of the acceleration as a vector amount and may be accustomed sense orientation, acceleration, vibration shock and falling. Small machined accelerometers square measure more and more gift in transportable electronic devices to discover the position of the device (Gray *et al.*, 2007). It's capable of menstruation how briskly the speed of object is dynamical. It generates associate a log voltage because the output that is employed as an input to the system. The measuring system employed in this machine controlled system is ADXL335. it's a 3 axis measuring system that senses the lean in 2 directions solely.

Associate measuring system is associate integrated device that measures correct acceleration, the acceleration experienced relative to free fall. Single and multi axis models (X, Y, Z) square measure accessible to discover magnitude and direction of the acceleration as a vector amount and may be accustomed sense orientation, acceleration, vibration shock and falling. Small machined accelerometers square measure more and more gift in transportable electronic devices to discover the position of





Fig. 19: Worth for passes by MEMS

the device it's a capable of menstruation how briskly the speed of object is dynamical. It generates associate a log voltage because the output that is employed as an input to the system. The measuring system employed in this machine-controlled system is ADXL335 it's a 3 axis measuring system that senses the lean in 2 directions solely. The availability voltage ranges from a pair of to 3.6 V as shown in Fig. 18 and 19.

### CONCLUSION

Intelligent wheel chair has been with success designed and tested. It's been primarily designed to cut back human effort in driving a chair. several existing systems of wheelchairs still have problem in moving manually. So, as to avoid that problem, rather than dominant the chair electrically or by gestures, we've got succeeded in moving the chair exploitation head motion and voice commands. once the voice commands and head motion square measure given by the disabled person sitting on the chair, exploitation speech recognition kit and measuring system device the commands square measure received and in step with those commands the motors can move the wheel chair. This wheel chair conjointly found will be stopped once meets associate obstacle.

### REFERENCES

Bhuiyan, M. and R. Picking, 2011. A gesture controlled user interface for inclusive design and evaluative study of its usability. *J. Software Eng. Appl.*, 4: 513-521.

Bourhis, G., O. Horn, O. Habert and A. Pruski, 2001. An autonomous vehicle for people with motor disabilities. *IEEE. Rob. Autom. Mag.*, 8: 20-28.

Ding, D., B. Parmanto, H.A. Karimi, D. Roongpiboonsopit, G. Pramana, T. Conahan and P. Kasemsuppakorn, 2007. Design considerations for a personalized wheelchair navigation system. *Proceedings of the 2007 29th Annual International Conference of the IEEE Engineering in Medicine and Biology Society*, August 22-26, 2007, IEEE, Lyon, France, pp: 4790-4793.

Gangopadhyay, S., S. Mukherjee and S. Chatterjee, 2013. Intelligent gesture controlled wireless wheelchair for the physically handicapped. *Proceedings of 5th International Conference on IRAJ*, September 15, 2013, Pune, India, pp: 47-52.

Gray, J.O., P. Jia, H.H. Hu, T. Lu and K. Yuan, 2007. Head gesture recognition for hands-free control of an intelligent wheelchair. *Ind. Robot Int. J.*, 34: 60-68.

Iturrate, I., J. Antelis and J. Minguez, 2009. Synchronous EEG brain-actuated wheelchair with automated navigation. *Proceedings of the 2009 IEEE International Conference on Robotics and Automation*, May 12-17, 2009, IEEE, Kobe, Japan, pp: 2318-2325.

Kalantri, R.A. and D.K. Chitre, 2013. Automatic wheelchair using gesture recognition. *Int. J. Eng. Adv. Technol. (IJEAT.)*, 2: 216-218.

Katevas, N.I., N.M. Sgouros, S.G. Tzafestas, G. Papakonstantinou and P. Beattie *et al.*, 1997. The autonomous mobile robot SENARIO: A sensor aided intelligent navigation system for powered wheelchairs. *IEEE. Rob. Autom. Mag.*, 4: 60-70.

Landi, A., 2003. Update on tetraplegia. *J. Hand Surg.*, 28: 196-204.

Lankenau, A. and T. Rofer, 2001. A versatile and safe mobility assistant. *IEEE. Rob. Autom. Mag.*, 8: 29-37.

Mazo, M., 2001. An integral system for assisted mobility (automated wheelchair). *IEEE. Rob. Autom. Mag.*, 8: 46-56.

Pajkanovic, A. and B. Dokic, 2013. Wheelchair control by head motion. *Serb. J. Electr. Eng.*, 10: 135-151.

Sathish Kumar, S. Pariselvam, 2012. Formative impact of gauss markov mobility model on data availability in MANET. *Asian J. Inform. Technol.*, 11: 108-116.

Seki, H., S. Kobayashi, Y. Kamiya, M. Hikizu and H. Nomura, 2000. Autonomous/semi-autonomous navigation system of a wheelchair by active ultrasonic beacons. *Proceedings 2000 ICRA Millennium IEEE International Conference on Robotics and Automation (Cat. No.00CH37065)*, Vol. 2, April 24-28, 2000, IEEE, San Francisco, California, USA., pp: 1366-1371.

Srishti, S. and P. Jain, 2015. The smart wheelchair using head gesture control. *Int. J. Adv. Eng. Sci. Technol. Res.*, 3: 2321-1202.

Veeraiah, J., P.A. Syam, N.N. Durga, K.R. Kanth and G. Vasudha, 2013. Accelerometer based gesture recognition for wheel chair direction control using ZIGBEE protocol. *Int. J. Technol. Explor. Learn.*, 2: 104-108.