

## Control of Torque and Unity Stator Side Power Factor of the Doubly-Fed Induction Generator

A. Chaiba, R. Abdessemed, M.L. Bendaas and A. Dendouga  
LEB-Research Laboratory, Department of Electrical Engineering,  
University of Batna, Chahid Med El Hadi Boukhrouf Batna 05000, Algeria

**Abstract:** In this study, a control of torque and unity stator side power factor of the Doubly-Fed Induction Generator (DFIG) is proposed. First, a mathematical model of the doubly-fed induction generator written in an appropriate d-q reference frame is established to investigate simulations. In order to control the rotor currents of DFIG, a control law is synthesized using PI controllers; under conditions of the stator side power factor is controlled at unity level. Results obtained in Matlab/Simulink environment, are presented illustrating a good control system performance.

**Key words:** Doubly-Fed Induction Generator (DFIG), modelling, control of torque, power factor

### INTRODUCTION

A doubly-fed induction generator is an electrical asynchronous three-phase machine with open rotor windings which can be fed by external voltages. The typical connection scheme of this generator is reported in Fig. 1. The stator windings are directly connected to the line grid, while the rotor windings are controlled by means of an PWM inverter, (Peterson, 2003; Bose, 1996). This solution is very attractive for all the applications where limited speed variations around the synchronous velocity are present, since the power handled by the converter at rotor side will be a small fraction (depending on the slip) of the overall system power. In particular, for electric energy generation applications, it is important to note that the asynchronous nature of the DFIG allows to produce constant-frequency electric power with a variable mechanical speed and to reduce copper losses, (Bose, 1996).

Different strategies were proposed in the study to solve the DFIG control problem. A vector controlled

doubly fed induction generator is an attractive solution for high performance and energy generation application (Peterson, 2003; Bose, 1996; Leonhard, 1995).

In this study, control of torque strategy is achieved by adjusting rotor currents and using stator voltage vector oriented reference frame. Simulation is investigated with PI regulators, under condition of unity stator side power factor. Simulation results present a high dynamic performance vector controlled doubly-fed induction generator.

### MATHEMATICAL MODEL OF THE DFIG

The equivalent two-phase model of the symmetrical DFIG is represented in stator voltage-vector oriented frame (d-q) is Peresada *et al.* (1998) and Tapia *et al.* (2003):

$$J \frac{d\omega}{dt} = [p\mu(\Psi_{qs} \cdot i_{dr} - \Psi_{ds} \cdot i_{qr}) - T_L - f\omega] \quad (1)$$

$$\frac{d\Psi_{ds}}{dt} = -\alpha_s \Psi_{ds} + \omega_s \Psi_{qs} + \alpha_s M i_{dr} + V_{ds} \quad (2)$$

$$\frac{d\Psi_{qs}}{dt} = -\alpha_s \Psi_{qs} - \omega_s \Psi_{ds} + \alpha_s M i_{qr} + V_{qs} \quad (3)$$

$$\frac{di_{dr}}{dt} = -\gamma_r i_{dr} + \omega_r i_{qr} + \alpha_s \beta \Psi_{ds} \quad (4)$$

$$-\beta p \omega \Psi_{qs} - \beta V_{ds} + \frac{1}{\sigma_r} V_{dr}$$

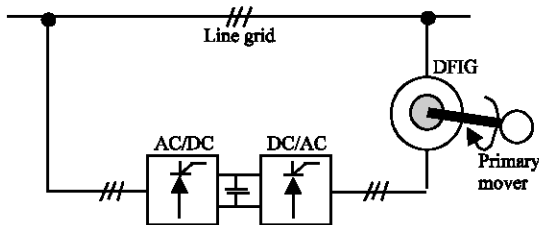

Fig. 1: The typical connection scheme of DFIG

$$\frac{di_{qr}}{dt} = -\gamma_r i_{qr} - \omega_r i_{dr} + \alpha_s \beta \Psi_{qs} + \beta p \omega \Psi_{ds} - \beta V_{qs} + \frac{1}{\sigma_r} V_{qr} \quad (5)$$

$$\dot{\theta} = \omega \quad (6)$$

Where:  $V_{ds}$ ,  $V_{qs}$ ,  $i_{ds}$ ,  $i_{qs}$ ,  $\Psi_{ds}$ ,  $\Psi_{qs}$  are rotor voltages, rotor currents and stator fluxes,  $T_L$  is a moving torque generated by the primary mover,  $U_m$  and  $\omega_s$  are stator (line) voltage amplitude and angular frequency,  $\theta$  and  $\omega$  are angular position and rotor speed,  $\omega_r = \omega_s - \omega$  is sleep angular frequency,  $p$  is number of pole pairs.

Positive constants related to DFIG electrical parameters are defined as:

$$\begin{aligned} \alpha_s &= R_s/L_s; \\ \sigma_r &= L_r(1-M^2/L_s L_r); \\ \beta &= M/(L_s \sigma_r); \\ \mu &= 3M/2L_s; \\ \gamma_r &= R_r/\sigma_r + (R_s M^2)/L_s^2 \sigma_r \end{aligned}$$

Where  $R_s$ ,  $R_r$ ,  $S_s$ ,  $R_r$ : Resistance and inductance of stator and rotor, respectively,  $M$ : Mutual inductance (Appendix 1).

Appendix 1: Doubly fed induction generator parameters (Persada *et al.*, 1998)

Rotor resistance	$R_r = 5.3 \Omega$
Rated current	5.2 A
Stator inductance	$L_s = 0.161 \text{ H}$
Rated voltage	220/380 V
Rotor inductance	$L_r = 0.161 \text{ H}$
Rated torque	15 Nm
Mutual inductance	$M = 0.138 \text{ H}$
Rated speed	880 rev/min
Number of pole pair	$p = 3$
Stator resistance	$R_s = 4.7 \Omega$
Friction coefficient	$f = 0.45$

### VECTOR CONTROL ALGORITHM FOR DFIG

Conditions of stator flux field orientation and line voltage orientation are equivalent if the stator side power factor is controlled at unity level (Tapia *et al.*, 2003; Pena *et al.*, 1996). Under such condition the stator flux modulus is not a free output variable but it is a function of the produced electromagnetic torque.

The reactive component of the stator current is practically equal to zero as it is the given working condition of DFIG control algorithm. Figure 2 shows the diagram control of power factor.

The setting of different vectors and transformation angles is represented in Fig. 3.

Under using this reference frame, the flux errors defined as:

$$\tilde{\Psi}_{ds} = \Psi_{ds}, \tilde{\Psi}_{qs} = \Psi_{qs} - \Psi^*, i_{qs}^* = 0.$$

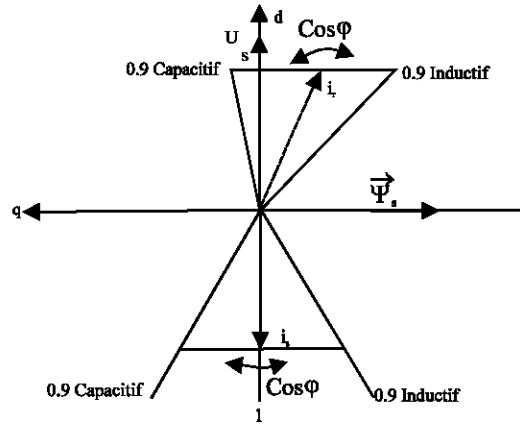

Fig. 2: Diagram control of power factor

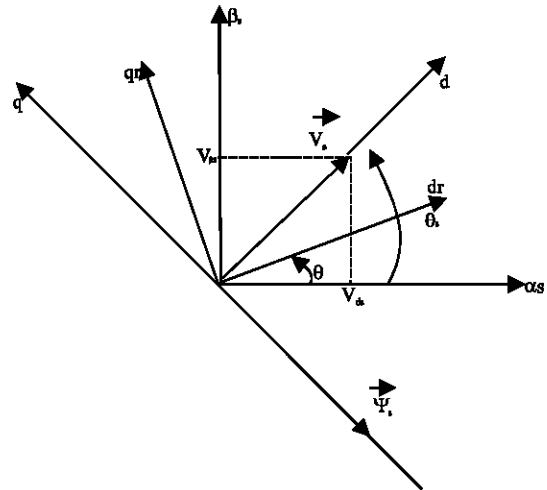

Fig. 3: Setting of vectors oriented and transformation angles

Where:  $\Psi^*$  is the flux level reference trajectory.

The complete equations of the vector control of the doubly-fed induction generator are given by:

Stator flux vector controller:

$$i_{qr}^* = \frac{1}{\alpha_s M} (\alpha_s \Psi^* + \dot{\Psi}^*) \quad (7)$$

$$\Psi^* = \frac{-U_m - (U_m^2 - 4(2/3)\omega_s R_s T_g^*)}{2\omega_s} \quad (8)$$

Torque controller:

$$i_{dr}^* = \frac{T_g^*}{\mu \Psi_{qs}^*} \quad (9)$$

Rotor current controller:

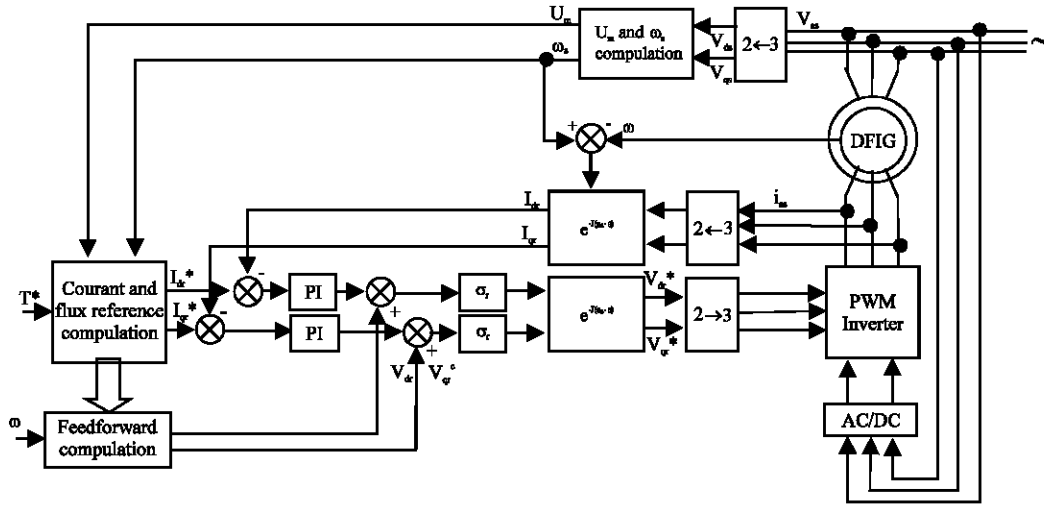

Fig. 4: Block diagram of the DFIG vector control

$$U_{dr} = \sigma_r [\gamma_r i_{dr}^* - \omega_r i_{qr}^* + \beta \omega \Psi^* + \beta U_m + \frac{di_{dr}^*}{dt} + kp \tilde{i}_{dr} + x_d]$$

$$U_{qr} = \sigma_r [\gamma_r i_{qr}^* + \omega_r i_{dr}^* - \beta \alpha_s \Psi^* + \frac{di_{qr}^*}{dt} - kp \tilde{i}_{qr} + x_q]$$

(10)

$$\dot{x}_d = -ki \cdot \tilde{i}_{dr}$$

(11)

$$\dot{x}_q = -ki \cdot \tilde{i}_{qr}$$

(12)

$$\tilde{i}_{dr} = i_{dr} - i_{dr}^*$$

(13)

$$\tilde{i}_{qr} = i_{qr} - i_{qr}^*$$

(14)

Where  $i_{dr}^*$ ,  $i_{qr}^*$  are rotor currents reference in (d-q) reference frame;  $k_p$  and  $k_i$  are positive proportional and integral gains of rotor current controllers;  $\Psi^*$  is stator flux reference;  $x_d$ ,  $x_q$  are integral components of current controllers.

Under such condition, the stator side active and reactive powers are given by:

$$P = -\frac{3}{2} U_m i_{ds}$$

(15)

$$Q = \frac{3}{2} U_m i_{qs}$$

(16)

The study, that we present, consists in using a generator where the rotor is supplied through a converter. This converter is based on PWM control algorithm (Zhang and Watthanasam, 1998) operating at 2 KHz switching frequency.

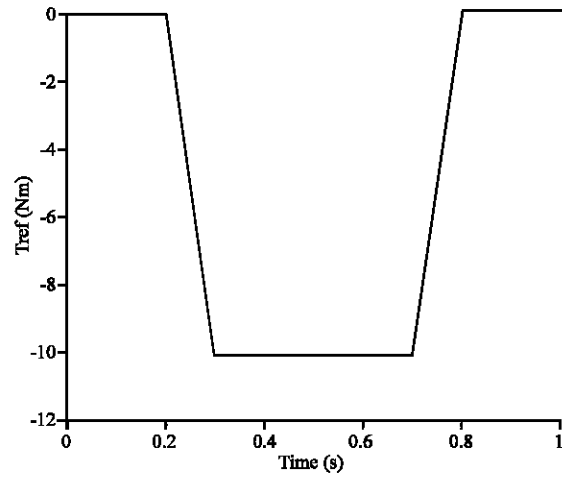

Fig. 5: Torque reference

The proportional and integral gains of the rotor current controllers have been set at  $k_p=500$ ,  $k_i=62040$ . All programs for controller implementation have been written using Matlab/simulink environment. The bloc diagram of the proposed controller is shown in Fig. 4.

The proportional and integral gains of the rotor current controllers have been set at  $k_p = 500$ ,  $k_i = 62040$ . All programs for controller implementation have been written using Matlab/simulink environment.

### SIMULATION RESULTS

The results reported in Fig. 5-14. was performed to investigate system behaviour during torque tracking. The sequence of operation during this test is shown in Fig. 5. The DFIG, already connected to the line grid, is required to track a trapezoidal torque reference, which starts at  $t = 0.2s$  from zero initial value and reaches the rated value of  $-10 \text{ Nm}$  at  $t = 0.3 \text{ s}$ .

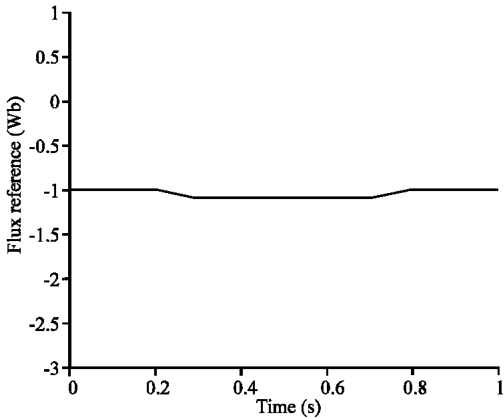

Fig. 6: Flux reference

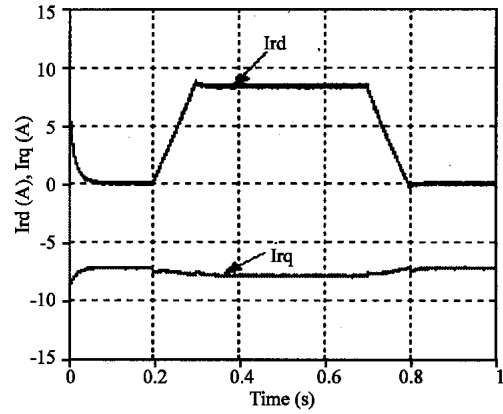

Fig. 9: Rotor currents responses  $I_{rd}$  and  $I_{rq}$

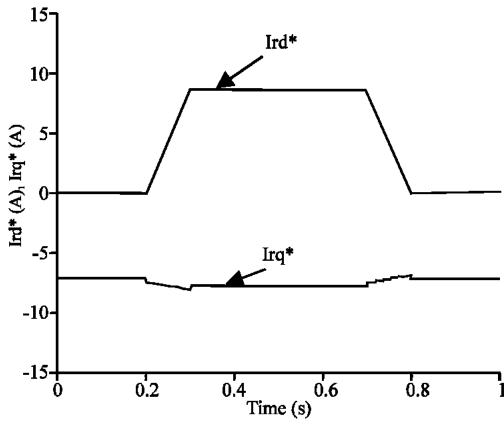

Fig. 7: Rotor reference currents  $I_{rd}^*$  and  $I_{rq}^*$

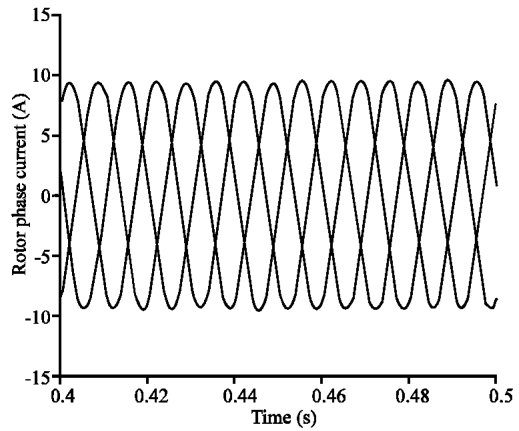

Fig. 10: Rotor phases currents

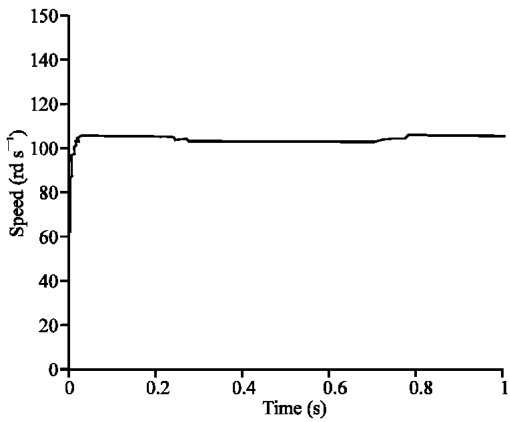

Fig. 8: Speed

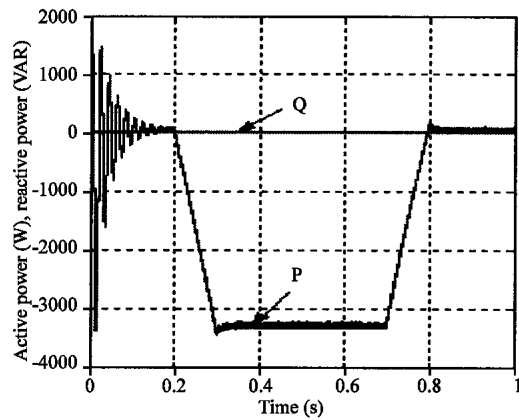

Fig. 11: Stator active power  $P$  and reactive power  $Q$

Note that flux value, required to track torque trajectory with unity power factor at stator side is not a constant. The rotor current is sinusoidal as shown in Fig. 10. Waveforms of the rotor reference currents and are shown in Fig. 7. The stator power follows the current as shown in Fig. 11. This results in unity power factor on the grid as the stator reactive power is zero. Rotor current

errors are controlled at zero level. The reactive component of the stator current is almost equal to zero during all the time. As result, the stator phase current, reported in Fig. 14, has an opposite phase angle to the line voltage one and shows a low content of high order harmonics.

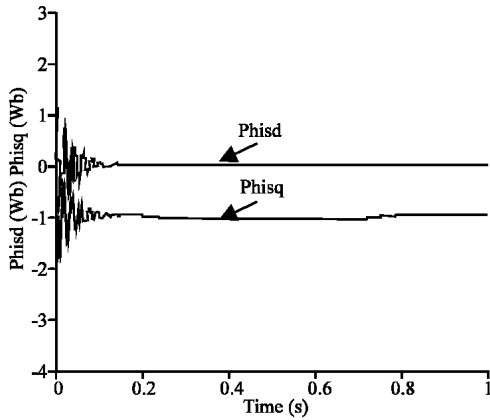

Fig. 12: Stator flux phisd and phisq

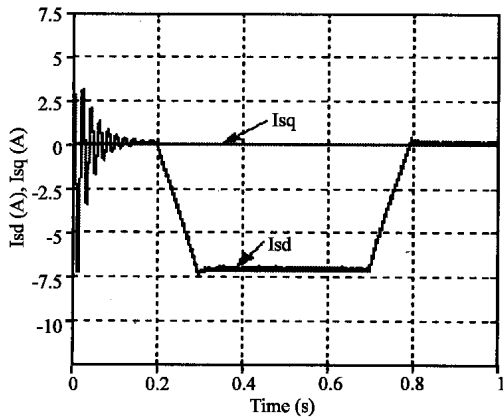

Fig. 13: Stator currents responses Isd and Isq

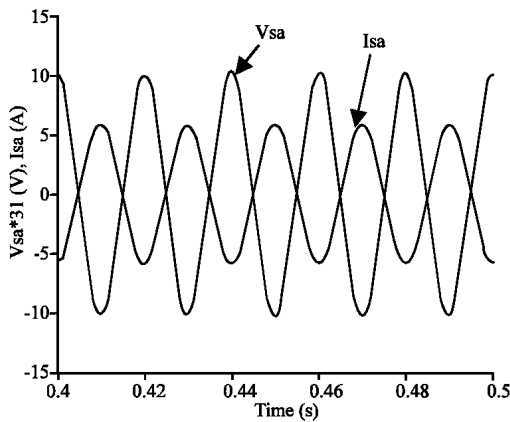

Fig. 14: Stator voltage and current

## CONCLUSION

In this study, a control of torque of the doubly-fed induction generator has been proposed. Vector-control strategy has been achieved by adjusting rotor currents and using stator voltage vector oriented reference frame. Simulations have been investigated with PI regulators. Results show high performance torque tracking under condition of unity stator side power factor. Finally the proposed control is suitable for electric energy generation applications with DFIG.

## REFERENCES

- Bose, B.K., 1996. Power Electronics and Variable Frequency Drives: Technology Applications, IEEE Press, New York.
- Leonhard, W., 1995. Control of Electric Drives, Springer-Verlag, Berlin.
- Pena, R., J.C. Clare and G.M. Asher, 1996. Doubly fed induction generator using back-to-back PWM converters and its application to variable-speed wind-energy generation, IEEE. Proc. Part B, 143: 231-241.
- Peresada, S., E. Chekhet and I. Shapoval, 1998. Asymptotic control of torque and unity stator side power factor of the doubly-fed induction machine, in Proceedings. Int. Conf. Problems Elec. Drives, Alushta, pp: 81-86.
- Petersson, A., 2003. Analysis, Modeling and control of Doubly-fed Induction Generator for wind turbines, tutorial's thesis, Chalmers university of technology, Göteborg, Sweden.
- Tapia, A., G. Tapia, J.X. Ostolaza and J.R. Saenz, 2003. Modiling and control of a wind turbine driven doubly fed induction generator, IEEE. Trans. Energy Conversion, 18: 194-204.
- Xu, L. and W. Cheng, 1995. Torque and reactive power control of a doubly-fed induction machine by position sensorless scheme, IEEE. Trans. Indus. Applications, 31: 636-642.
- Zhang, L. and C. Watthanasarn, 1998. A matrix converter excited Doubly-fed Induction Machine as a wind power generator, IEEE. Conf. Pub. N456, Power Elec. Variable Speed Drives, pp: 532-537.