

Optimal Location of Power System Stabilizers in a Multi Machine Power System Using Relative Gain Array (RGA) and Genetic Algorithm (GA)

A. Mahabuba and M. Abdullah Khan

Department of EEE, B.S.A. Crescent Engineering, India

Abstract: This study deals with the identification of best locations for placing the Power System Stabilizers (PSSs) in order to improve the overall dynamic stability of multimachine power systems using Relative gain Array (RGA) Analysis and Genetic Algorithm(GA) search technique. RGA is a simple and effective measure of interaction among the control loops in a Multi Input-Multi Output (MIMO) system. This study investigates the use of Relative Gain Array (RGA) for the selection of an appropriate set of manipulated variables to control a set of specified output through PSSs. The algorithm for identifying optimal location of PSS proposed in this paper uses the RGA in frequency domain computed at the frequency of the critical swing mode and rearranging the rows and columns of the RGA using an optimization search procedure guided by Genetic Algorithm (GA). The validity of the proposed algorithm is tested using a 5 machine, 8 bus test system and the results obtained demonstrate the effectiveness of the proposed algorithm.

Key words: Small signal stability, Power System Stabilizers (PSSs), stabilization of multi machine power system, Relative Gain Array (RGA), Genetic Algorithm (GA)

INTRODUCTION

Power Systems are highly complex systems that contain non-linear and time varying elements. Many power systems face the problem of troublesome dynamic oscillations in the range of 0.1 to 2.5 Hz associated with some poorly damped swing modes. Power System Stabilizers (PSSs) are commonly used to damp these oscillations by increasing the damping of critical swing modes (Padiyar, 1996).

In the application of PSS to increase the damping of troublesome modes in a multimachine power system, the very first step is to determine the best location for placing PSSs. For a local mode the job of selecting the PSS location is not difficult because only few machines are involved in this local oscillation and there are only a few choices. But for an interarea mode, large number of machines may be involved in the oscillation. This makes the PSS location selection problem very complicated (Lakshmi and Abdullah, 2000).

In a multi machine power system, it is possible to have a PSS at each machine. But in practice only PSSs located at certain machines would result in better damping of all rotor modes. Improper location of stabilizers would lead to higher stabilizer gains and would result in severe deviation in voltage profile under disturbance conditions. In some cases, the stabilizer may even cause operation of generators at leading power factor. Siting the stabilizers at

the best location is therefore an important factor in a multi machine system to obtain a stable closed loop system with well damped rotor modes using small stabilizer gains (Kundur *et al.*, 1989).

The PSS location selection problem has been studied for a long time. The most commonly used approach for stabilizer siting is the Eigen Vector method proposed by Mello and Concordia (1969). This method may fail in certain circumstances and may lead to undesirable stabilizer location as found out in various studies (Hsu and Chen, 1987; Hsu and Cheny, 1990).

Hsu and Chen (1987) and Hsu and Cheny (1990) presented the method of using Participation Factors for the identification of the location of Power System Stabilizers (PSSs) for the multi machine power system.

Hiyama (1983) presented an approach using the concept of coherent groups. This method suffers from the major disadvantage that generators within one coherent group for a large disturbance do not necessarily remain in the same group under small-disturbance conditions. Again, the selection of particular generator to be equipped with PSS within one coherent group is somewhat arbitrary.

Zhout *et al.* (1991) proposed another approach based on Sensitivity of PSS Effect (SPE) for the selection of location of PSS in multi machine power systems. The concept of Sensitivity of PSS Effect includes both input

and control information of PSS and hence can also be used to predict the performance of PSS.

Nam *et al.* (2000) developed a new second-order eigen sensitivity of the augmented system matrix using only eigen values and their left and right eigen vectors.

Milanovic *et al.* (2001, 2004) suggested Relative Gain Array (RGA) analysis for the determination of location of PSS in multi machine power systems. This method is not suitable for the large system which involves time consuming complicate manipulations in rearranging the RGA matrix to determine the best input-output pair.

The present study deals with use of RGA and Genetic Algorithm in the selection of optimum location of PSSs in a multi machine power system in order to achieve the best possible damping of critical electromechanical modes. Genetic algorithm is used to simplify the manipulations of the RGA matrix which makes this method very attractive for large scale power systems for the placement of Power System Stabilizers for improving the damping of the critical swing modes. RGA can be an alternative to modal analysis for systematic application to large power systems.

DYNAMIC STABILITY MODEL OF A MULTI MACHINE POWER SYSTEM

This study uses the two-axis model with four state variables for synchronous machine. The linearized state equations representing the synchronous machine with the assumption $x_d' = x_q' = x'$ are as follows (Anderson and Fouad, 2003):

$$\begin{aligned} \bullet & \\ \Delta E_{d'1} &= \{ -\Delta E_{d'1} - (x_{qi} - x'_i) \Delta I_{qi} \} / \tau_{qo'i} \\ \bullet & \\ \Delta E_{q'1} &= \{ \Delta E_{FDi} - \Delta E_{q'1} + (x_{di} - x'_i) \Delta I_{di} \} / \tau_{do'i} \\ \bullet & \\ \Delta \omega_{ri} &= \{ \Delta T_{mi} - (I_{d'0} \Delta E_{d'1} + I_{q'0} \Delta E_{q'1} + E_{d'10} \Delta I_{di} + E_{q'10} \Delta I_{qi}) - D_i \omega_{ri} \} / \tau_{ji} \quad i = 1, 2 \dots m \\ \bullet & \\ \Delta \delta_i &= \omega_{r1} - \omega_{ri} \quad ; \quad i = 2, 3 \dots m \text{ taking machine 1 as reference.} \end{aligned} \quad (1)$$

Where,

- E_d' - Direct axis component of voltage behind transient reactance.
- E_q' - Quadrature axis component of voltage behind transient reactance.
- ω_r - Angular velocity of rotor.
- δ - Rotor angle in electrical radians.
- x_d' - Direct axis transient generator reactance.
- x_q' - Quadrature axis transient generator reactance in p.u

The static type (IEEE Type ST 1A) exciter is used (Kundur, 1994). The linearized state equation for the exciter is:

$$\Delta \dot{E}_{fdi} = \frac{-K_{Ai}}{\tau_{Ai}} (-\Delta V_{Ref_i} + \Delta V_i) - \frac{1}{\tau_{Ai}} \Delta E_{fdi} \quad ; \quad i = 1, \dots, m \quad (2)$$

Where,

- E_{FD} - Equivalent stator emf proportional to field voltage
- K_A - Gain of the exciter
- τ_A - Time constant in secs
- V_i = Terminal voltage of the machine
- V_{Ref1} = Reference voltage of the machine

In Eq. 1 the currents I_{di} and I_{qi} and voltages E_{di}' and E_{qi}' are referred to the rotor axis of the individual machine. The loads are modeled as constant impedance loads. The network equation is represented as:

$$\hat{I} = Y \hat{V} \quad (3)$$

Where,

Y is the admittance matrix of the reduced network pertaining to the generator nodes only.

\hat{V}_i and \hat{I}_i are the machine nodal voltage and current referred to the common frame of reference. It can be converted into individual machine rotor reference by defining

$$\hat{V}_i = \bar{V}_i e^{j\delta_i}, \hat{I}_i = \bar{I}_i e^{j\delta_i} \quad i = 1, \dots, m \quad (4)$$

Where,

\bar{V}_i and \bar{I}_i are the voltage and current referred to the rotor axis of the individual machine i .

The Eq. 4 can be written as:

$$\hat{V} = T \bar{V}; \hat{I} = \bar{I} \quad (5)$$

Where,

$$T = \begin{bmatrix} e^{j\delta_1} & 0 & \dots & 0 \\ \dots & e^{j\delta_2} & \dots & 0 \\ \dots & \dots & \dots & 0 \\ \dots & \dots & \dots & 0 \\ 0 & 0 & 0 & 0 & e^{j\delta_m} \end{bmatrix} \quad (6)$$

Using Eq. 5, the 3 becomes

$$\bar{I} = \bar{M}\bar{V} \quad (7)$$

Where,

$$\bar{M} = T^{-1}YT \quad (8)$$

To connect the machine equations and network equations by invoking the assumption, $x_d' = x_q' = x'$, we get the voltage-current equation for the machine as:

$$E_i' = \bar{V}_i + jx_i' \bar{I}_i \quad (9)$$

Now linearize the Eq. 7 and then separating into real and imaginary parts, we get the equations for ΔI_{di} and ΔI_{qi} as per (Anderson and Fouad, 2003). Now in the equations of ΔI_{di} and ΔI_{qi} , using the assumption $x_d' = x_q' = x'$ and Eq. 9, we will get the complete set of linearized state equation (Anderson and Fouad, 2003).

$$[\dot{X}] = [A][X] + [B][U] \quad (10)$$

For the two axis model, there are 5 state variables which includes four state variables for the machine ($E_d', E_q', \omega_r, \delta'$ and one state variable for the static exciter ' E_{FD}' ') and 'm' is the total number of machines. In Eq. 10 the dimensions of the following are,

- A : System matrix of size $(5*m^{-1}) \times (5*m^{-1})$
- X : State vector of size $(5*m^{-1}) \times 1$
- B : Input matrix of size $(5*m^{-1}) \times m$
- U : Input vector of size $(m \times 1)$

Where U vector denotes $\Delta V_{refi}, i = 1, \dots, m$

The Conventional Power System Stabilizer (CPSS) which has $\Delta \omega_r$ signal (Speed signal) as input and ΔV_s (stabilizer signal to exciter) as output is used as the controller in this study. It involves a transfer function consisting of an gain block, a washout block and first order lead-lag compensator block (Kundur, 1994).

PROPOSED METHOD FOR OPTIMAL LOCATION OF PSSS

The proposed study deals with use of Relative Gain Array and Genetic Algorithm in the selection of optimum location of PSS in a multi machine power system in order to achieve the best possible damping of critical electromechanical modes.

The RGA is calculated on the basis of transfer functions between the selected outputs and inputs. The Relative Gain Array (RGA) was introduced as a steady-state measure of interactions for multivariable,

decentralized control by Bristol (1966) and then modified by Shinskey and then further improved by McAvoy. It was later extended to frequency domain.

The proposed method uses the following approach: The eigen values are found out from the "A" matrix. The critical modes and nature of this critical modes are identified. The RGA matrix is computed for the frequency of the first critical mode. The RGA matrix is rearranged to make it diagonal dominant. From this modified RGA matrix, the element which is closer to one is used to damp the particular critical mode.

Relative Gain Array (RGA): The RGA is a matrix R which characterizes an MIMO system (Stephamopoulos, 2006). The elements r_{ij} represents the relative gain for an input-output control pair, y_i - u_j and is defined as the ratio of uncontrolled gain to controlled gain.

Consider two input-two output system in (Fig. 1). The relative gain R_{12} for the pair u_1 - y_2 is defined as:

$$R_{12} = \frac{UG_{12}}{CG_{12}}$$

The Uncontrollable Gain (UG_{12}) can be obtained by introducing a step Δu_1 in the input u_1 and measuring the output change Δy_2 , keeping all other inputs (u_2) constant.

$$\text{i.e., } UG_{12} = \left. \frac{\Delta y_2}{\Delta u_1} \right|_{\Delta u_2 = 0} \quad (11)$$

Then Controlled Gain (CG_{12}) can be obtained by introducing a step change Δu_1 and measuring the output Δy_2 by keeping all other outputs (y_1) constant through a feedback control on the respective input variation (u_2). (Fig. 2).

$$\text{i.e., } CG_{12} = \left. \frac{\Delta y_2}{\Delta u_1} \right|_{\Delta y_1 = 0} \quad (12)$$

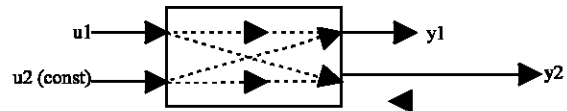

Fig. 1: Two input-two output system

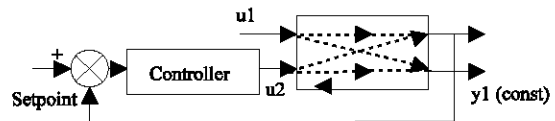

Fig. 2: Controlled Gain (CG_{12})

The relative gain between output y_2 and input u_1 is the ratio of Uncontrolled Gain (UG_{12}) to Controlled Gain (CG_{12}).

$$R^{12} = \frac{UG_{12}}{CG_{12}} = \frac{\left. \frac{\Delta y_2}{\Delta u_1} \right|_{\Delta u_2=0}}{\left. \frac{\Delta y_2}{\Delta u_1} \right|_{\Delta y_1=0}} \quad (13)$$

In general the RGA matrix R in s- domain can be calculated as follows:

$$R = G(s) \otimes [G(s)^{-1}]^T \quad (14)$$

Where, $G(s)$ is the transfer function matrix of a multi input multi output the system, the symbol \otimes denotes element by element multiplication.

In frequency domain, the RGA matrix can be calculated for the frequency corresponding to the critical mode. Then the rows and columns of the RGA matrix are rearranged in such a way that the RGA matrix is closer to identity matrix. This is done by the application of Genetic Algorithm. The important property of RGA matrix is that each row and each column sum to one.

Interpretation of the significant Relative Gain Array (RGA) element: The modified RGA matrix after the rearrangement of columns and rows of the original RGA matrix using genetic algorithm is similar to the identity matrix. The ideal modified RGA matrix is a diagonal dominant (identity) matrix. The other rows and columns of the modified RGA matrix are zero.

If the value of the significant element of modified RGA matrix is one (i.e.,) $r_{ij} = 1$. then the value of the other elements are zero. Then, the uncontrolled gain UG_{ij} is same as the controlled gain CG_{ij} which implies that the input 'u_j' does not affect the output 'y_j' and the control loop between y_j- u_j doesn't interact with the other control loops (y_i-u_j). This case is the ideal case.

But in practice, the value of r_{ij} is not equal to one, but is closer to one. The sum of the corresponding row and also the sum of the sum of the column is nearly equal to zero.

From the above discussion, we can conclude for the selection of loops from the RGA matrix as follows.

- The RGA matrix is used to find the best input-output signals which give the good control.
- hBecause of the selection of this input-output pair, the interaction effects by the other loops on this loop should be minimal.

As per the above two points the loop should be selected which has the less interaction and also the Input-output variables which have good control effect on each other. Hence RGA element which is equal to one or very closer to one is to be chosen which indicates less interaction on the other loops if any and has good control on each other.

Genetic algorithms in RGA: A genetic algorithm works with a population of strings known as chromosomes. The RGA is a matrix of numbers each of which represents the relative influence of a given input on a defined output, is manipulated by moving complete rows or columns, until it most closely approximate to the ideal solution, represented by the identity matrix (French *et al.*, 1945). For small systems such manipulations are straight forward. However, as systems become larger such manipulations become more complex and some automated search solution like genetic algorithm is advisable. To utilize the Genetic Algorithm for the optimal input-output parings, the relative placement of the row/columns of the RGA must be encoded. In this study, two strings are selected. One for row and another for column. The two strings contain only integers in the range one to row/column length.

Fitness function: It is the function of the sum of the absolute differences between the candidate solution and template matrix:

$$\sum_{i=1}^n \sum_{j=1}^n |C_{ij} - T_{ij}|$$

C- Candidate solution[row/ column sting(RGA)]

T- Template matrix

$$T = \begin{bmatrix} 1.0 & 0.8 & 0.6 & 0.4 & 0.2 \\ 0.8 & 1.0 & 0.8 & 0.6 & 0.4 \\ 0.6 & 0.8 & 0.1 & 0.8 & 0.6 \\ 0.4 & 0.6 & 0.8 & 1.0 & 0.8 \\ 0.2 & 0.4 & 0.6 & 0.8 & 0.8 \end{bmatrix}$$

The above technique can be applied to the RGA matrix calculated for the large system which has the dominant off-diagonal terms and in order to move the off-diagonal terms to the leading diagonal by moving its complete rows or columns until it most closely approximate to the ideal solution with out changing the input and output configuration of the original matrix.

SAMPLE SYTEM AND RESULTS

The test system taken for analysis is 5 machine 8 bus system (El-Metawally and Malik, 1996). The one line diagram of this sample system is given in Appendix-1. The system data: The bus data, line data, generator data and the exciter data is given as in Lakshmi and Mbdullah (2000). The test system consists of two areas; the area 1 with generators 2,3 and 5 and load1 and the area 2 with generators 1 and 4 and with the loads 2 and 3. All the machines are represented by two axis model with five states variables. The loads are modeled as constant impedances. A full-load operating condition of the system is analyzed.

Initially the system matrix 'A' is computed for the system. From the A matrix, the eigen values are found out (Fig. 3). The critical swing modes are identified and then damping ratio and frequency of the critical modes are found out. For this test system there are three critical electromechanical modes were identified and they are tabulated with their damping ratios and frequencies are shown in the Table 1. The critical damping ratio, α_{cr} is chosen as 0.05.

Damping of the first critical mode of frequency 0.52 Hz:
The RGA was calculated at the frequency for the first critical mode (i.e.,) 0.52HZ and is shown in the Table 2.

The modified RGA matrix after the application of Genetic Algorithm (GA) is shown in Table 3.

In the Table 3 all the dominant values of the RGA matrix are located in the leading diagonal.

The element at the location 4-4 is much closest to unity among all the four diagonal elements and hence machine 4 which has the ΔV_{s_4} and $\Delta \omega_4$ is chosen for the placement of PSS. The gain of the stabilizer is tuned by trial and error method and the gain of the PSS at machine 4 for the improvement of 0.52HZ mode was fixed at 60. The damping ratios before and after the placement of PSS at machine 4 are shown in the Table 4.

From Table 4, it is observed that by placing the PSS in the fourth machine, the damping of the first critical mode and the second critical mode are improved.

The system response without the conventional PSS is shown in Fig. 4-7.

The following Fig. 8-11 shows the system response for $\Delta \Delta_{12}$ to $\Delta \Delta_{15}$ with the PSS located in machine 4.

Figure 8-11 System response when PSS located in machine 4.

Damping of Third Critical Mode of frequency 1.80 Hz

Then, the RGA is calculated for the 1.80HZ mode is shown in the Table 5 which indicates the location 2-2. The gain value of the PSS at machine 2 is tuned using trial and error method to the value of 140.

Appendix-1
test system

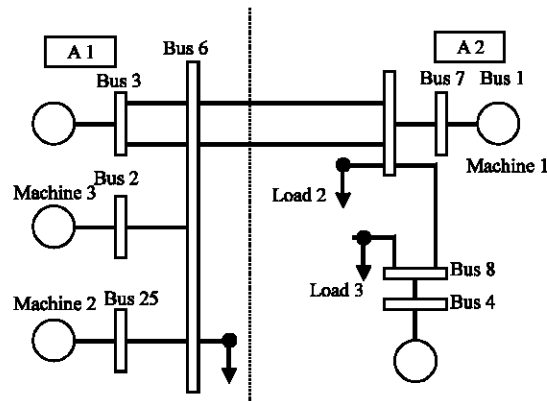

Table 1: Electromechanical modes of test system

SNo	Eigen values	Damping ratio	Frequency in p.u/Hz
1	-0.0001+j 0.0085	0.0068	0.0014(0.52 HZ)
2	-0.0002+j 0.0206	0.0101	0.0033(1.24HZ)
3	-0.0015+j 0.0304	0.0484	0.0048(1.80HZ)

Table 2: RGA matrix for 0.52 HZ mode

$\Delta \omega$	ΔV_{s_1}	ΔV_{s_2}	ΔV_{s_3}	ΔV_{s_4}	ΔV_{s_5}
$\Delta \omega_1$	1.0158	-0.01089	0.001265	-0.00617	0
$\Delta \omega_2$	0.000897	0.068138	0.93098	-1.16E-05	0
$\Delta \omega_3$	-0.01139	0.94365	0.067984	-0.00025	0
$\Delta \omega_4$	-0.00532	-0.0009	-0.00023	1.0064	0
$\Delta \omega_5$	-7.58E-17	2.88E-16	9.04E-17	3.58E-18	1

Table 3: Modified RGA matrix for 0.52 Hz after the application of GA

Column/Row	ΔV_{s_1}	ΔV_{s_2}	ΔV_{s_3}	ΔV_{s_4}	ΔV_{s_5}
$\Delta \omega_1$	1.0158	0.001265	-0.01089	-0.00617	0
$\Delta \omega_2$	0.000897	0.93098	0.068138	-1.16E-05	0
$\Delta \omega_3$	-0.01139	0.067984	0.94365	-0.00025	0
$\Delta \omega_4$	-0.00532	-0.00023	-0.0009	1.0064	0
$\Delta \omega_5$	-7.58E-17	9.04E-17	2.88E-16	3.58E-18	1

Table 4: Improvement in the damping ratio for 0.52 HZ mode

S.No	Damping ratio before PSS	Damping ratio when PSS at machine 4
1	0.0068	0.3311
2	0.0101	0.359
3	0.0484	0.0484

The improvement in the damping ratio for the third critical mode whose frequency is 1.80 Hz with the placement of PSS in machine 2 is shown in the Table 6. From Table 6, it is observed that the PSS located at machine 2 improves all the damping of the first critical mode and third critical mode 3.

The system response with PSS located in machine 2 and without PSS is shown in Fig. 12-15.

Figure 12-15 system response when PSS located in machine 2.

Table 7 shows the comparison for the improvement in damping ratios when PSS located in Machine 4, Machine 2 and Machine 4 and 2.

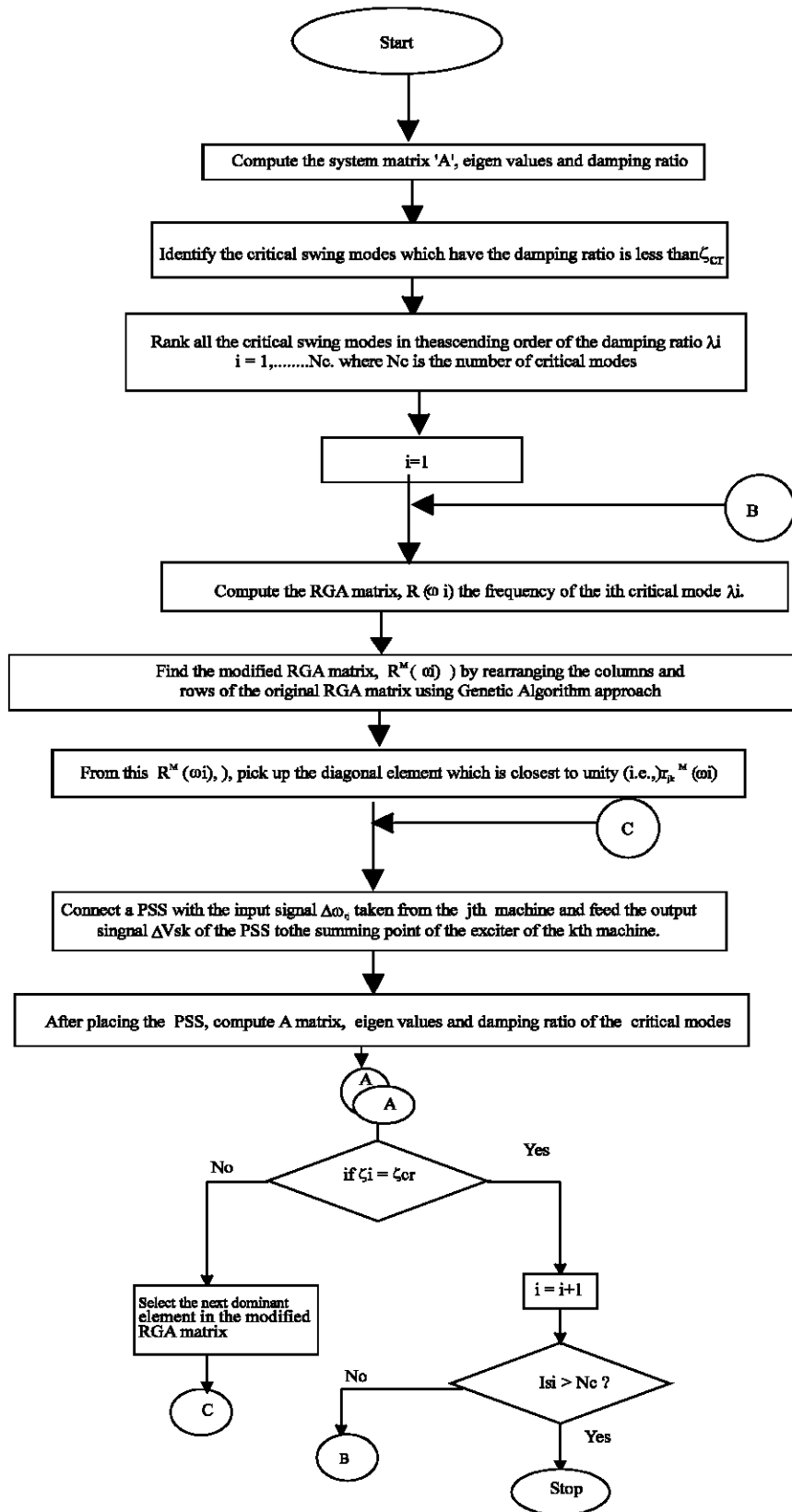

Fig. 3: Flowchart for the proposed method

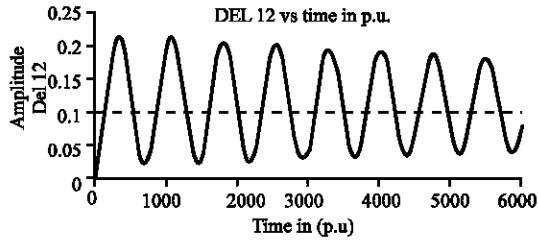

Fig 4: System response for $\Delta\delta_{12}$ without PSS

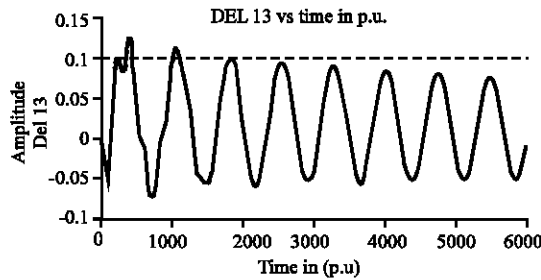

Fig 5: System response for $\Delta\delta_{13}$ without PSS

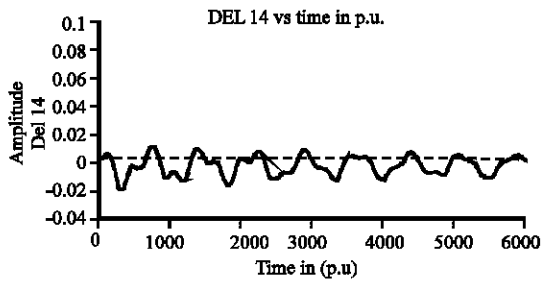

Fig 6: System response for $\Delta\delta_{14}$ without PSS

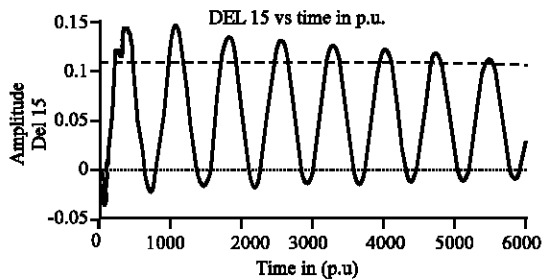

Fig 7: System response for $\Delta\delta_{15}$ without PSS

By placing the PSS in machine 4 and machine 2 improves all the critical modes. The system response also proven this result. Figure 16-19 shows the system response when PSS located in machine 4 and machine 2.

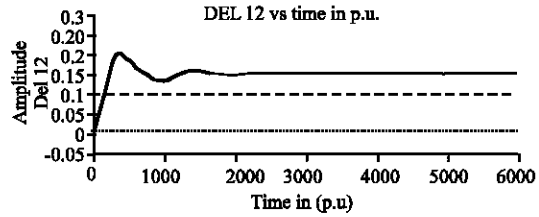

Fig. 8: System response for $\Delta\delta_{12}$ with PSS in Machine 4

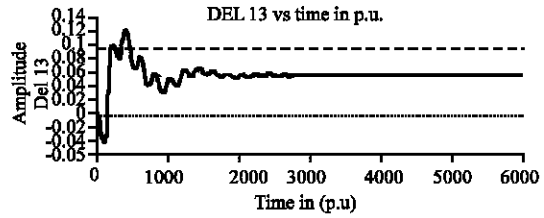

Fig. 9: System response for $\Delta\delta_{13}$ with PSS in Machine 4

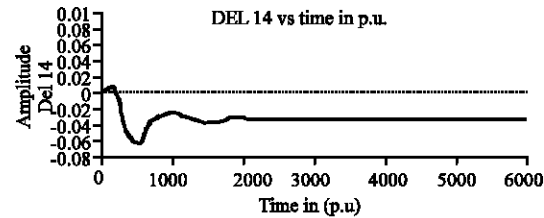

Fig 10: System response for $\Delta\delta_{14}$ with PSS in Machine 4

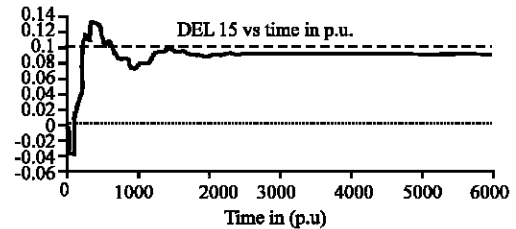

Fig 11: System response for $\Delta\delta_{15}$ with PSS in Machine 4

Table 5: The RGA for the mode 1.80HZ

Column/Row	ΔV_{s1}	ΔV_{s2}	ΔV_{s3}	ΔV_{s4}	ΔV_{s5}
$\Delta\omega_1$	1.0428	0.006887	-0.00046	-0.04926	0
$\Delta\omega_2$	0.006539	1.0354	-0.0422	0.000286	0
$\Delta\omega_3$	0.000258	-0.04295	1.0427	1.07E-05	0
$\Delta\omega_4$	-0.04962	0.000685	-2.28E-05	1.049	0
$\Delta\omega_5$	-1.61E-17	-3.82E-16	3.32E-18	-1.46E-18	1

Table 6: Improvement in the damping ratio for 1.80HZ mode

S.No	Damping ratio before PSS	Damping ratio when PSS at machine 2
1	0.0068	0.4496
2	0.0101	0.0139
3	0.0484	0.115

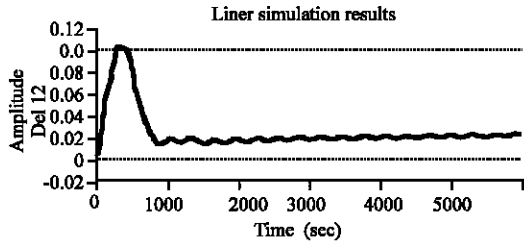

Fig 12: System response for $\Delta\delta_{12}$ with PSS in Machine 2

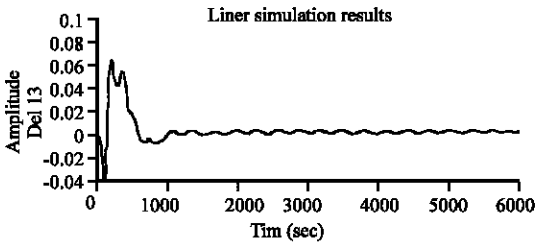

Fig 13: System response for $\Delta\delta_{13}$ with PSS in Machine 2

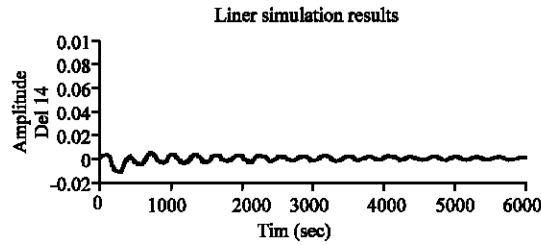

Fig 14: System response for $\Delta\delta_{13}$ with PSS in Machine 2

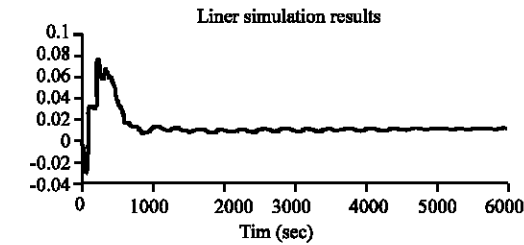

Fig 15: System response for $\Delta\delta_{15}$ with PSS in Machine 2

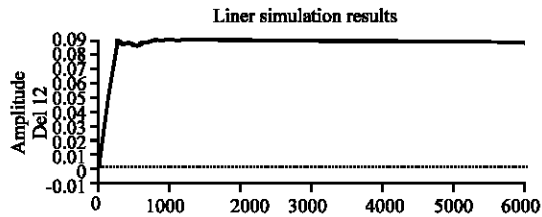

Fig. 16: System response for $\Delta\delta_{12}$ with PSS in Machine 4 and 2

Table 7: Improvement in the damping ratio for PSS at machines 4 and 2

S.no	Mode no.	No PSS	PSS in machine 4	PSS in machine 2	PSS in machine 4 and 2
1	Critical Mode 1	0.0068	0.3311	0.4496	0.7758
2	Critical Mode 2	0.0101	0.359	0.0139	0.115
3	Critical Mode 3	0.0484	0.0484	0.115	0.3585

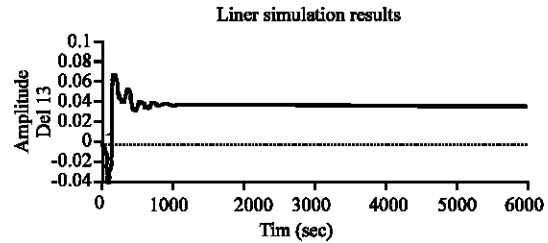

Fig. 17: System response for Δ_{13} with PSS in Machine 4 and 2

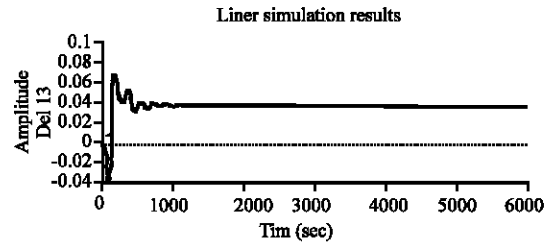

Fig. 18: System response for Δ_{14} with PSS in Machine 4 and 2

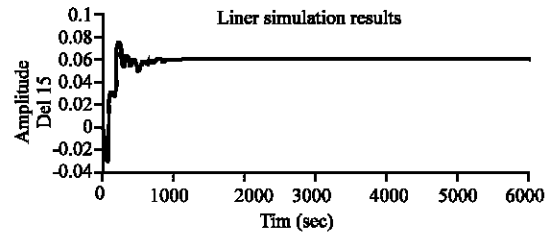

Fig. 19: System response for Δ_{15} with PSS in Machine 4 and 2

Figure 16-19 system response when PSS located in machine 4 and machine 2.

CONCLUSION

This study analyzes the possibility of use of Relative Gain Array (RGA) and Genetic Algorithm (GA) for the location of Power system stabilizers for damping electromechanical oscillations in the multi machine power system. The Relative Gain Array used to find out the best input-output pairing which has the good control to damp the critical modes. And also this input-output pair is used to minimize amount of interaction between the other control loops if any.

The Genetic algorithm search technique used in this study is very effective for large scale power systems.

The results obtained using the test system demonstrates the effectiveness of the proposed method. The Relative Gain Array (RGA) analysis and Genetic Algorithm (GA) is used in the Five- machine Eight-Bus El Metawally Malik test system to select the best possible place for the location of the PSSs to damp the critical modes.

ACKNOWLEDGEMENT

I express my sincere thanks to my guide Dr. M.Abdullah Khan, Professor, Department of Electrical and Electronics Engineering, B.S.A. Crescent Engineering College, India for his valuable guidance in preparing this research study.

REFERENCES

- Anderson, P.M. and A.A. Fouad, 2003. Power system control and stability. The Iowa state university press, Ames, IOWA, USA, Galgotia Publication, Vol. 1.
- Bristol, E.H., 1966. On a new measure of interaction for multivariable process control. IEEE. Trans. Automatic Control, AC-11: 133-134.
- De-Mello, F.P. and C. Concordia, 1969. Concepts of synchronous machine stability as affected by excitation control. IEEE. Trans. Power Apparatus Sys., 88: 316-329.
- El- Metawally, K.A. and O.P. Malik, Application of fuzzy logic stabilizers in a multi machine power system environment. IEEE. Proc. Part C, 143: 263-268.
- French, I.G., C.K.S. Ho and C.S. Cox, 1995. Genetic Algorithms in Controller Structure Selection. IEEE. Conf. Pub. Innovation and Application, pp: 12-14.
- Hae-Kon Nam, Yong-Ku Kim, Kwan-Shik Shim and Y. Kwang Lee, 2000. A New Eigen-Sensitivity Theory of Augmented Matrix and its Applications to power systems stability Analysis. IEEE. Trans. Power Syst., 15: 363-369.
- Hiyama, T., 1983. Coherency based identification of optimum site for stabilizer applications. IEEE. Proc. Part C, 130: 71-74.
- Hsu, Y.Y. and C.H. Cheng, 1990. Design of fuzzy power system stabilizer for multi- machine power systems. IEEE. Proc. Part C, 137: 233-238.
- Hsu, Y.Y. and Chen C.L., 1987. Identification of optimum location for stabilizer applications using participation factors. IEEE. Proc. Part C, 134: 238-224.
- Kundur, P., 1994. Power System Stability and Control, McGraw Hill Inc, New York.
- Kundur, P., M. Klein, G.J. Rogers and M.S. Zywno, 1989. Application of power system stabilizers for the enhancement of overall system stability. IEEE. Trans. Power Syst., 4: 614-626.
- Lakshmi P. and M. Abdullah Khan, 2000. Stability enhancement of a multi-machine power system using fuzzy logic based power system stabilizer tuned through genetic algorithm. Int. J. Elec. Power Energy Syst., 22: 137-145.
- Milanovic, J.V. and A.C. Serrano Duque, 2001. The Use of Relative Gain Array for Optimal Placement of PSSs. IEEE Power Eng. Soc. Winter Meeting Columbus, OH.
- Milanovic, J.V. and A.C. Serrano Duque, 2004. Identification of Electromechanical Modes and Placement of PSSs Using Relative Gain Array. IEEE. Trans. Power Syst., pp: 19.
- Padiyar, K.R., 1996. Power System Dynamics and Control. J. Wiley.
- Stephanopoulos, G., 2006. Chemical Process Control An Introduction to Theory and Practice. Prentice-Hall of India.
- Zhout, E.Z., O.P. Malik and G.S. Hope, 1991. Theory And Method For Selection of PSSs Location IEEE. Trans. Energy Conversion, 6: 170-176.