

Technique of the Diagnosis and Detection of the Defects Electric of the Asynchronous Machine

¹A. Medoued, ¹A. Metatla, ²T. Bahi and ³A. Boukadoum

¹Department of Electrotechnic, ²Department of Mechanics,

Faculty of Engineering Science, University of Skikda, Algeria

³Department of Electrotechnic, Faculté des Sciences de l'Ingénieur,

Université Badji Mokhtar, Algeria

Abstract: In this study, we approach the diagnosis of the stator and rotor defects in the asynchronous squirrel-cage machines. After having evoked the principal defects being able to occur, we propose a model of the machine based on the method of circuits magnetically coupled. This model makes it possible to study the influence of the defect of short circuit and break of bar, on the general behavior of the asynchronous motor. In complement of the undertaken study, we will highlight the importance of the analysis of the signals for the diagnosis of the stator and rotor defects.

Key words: Induction motor, modeling, diagnosis, detection, short circuit, rupture of bar

INTRODUCTION

With the development of the modern techniques of the diagnosis and order, the modeling of the asynchronous machine in the space of state proves to be essential. The control without sensors makes it possible to improve the robustness and the reliability of the machine and to reduce the cost of the systems of drives at variable speed. Thanks to the advantages: robust, cost, the simple construction and least of maintenance the machine with induction remains very appreciated in the industrial world for the applications which require a high dynamic performance.

Various study on the estimate in real time of the sizes and the parameters was completed. However, the techniques based on observers of Luenberger and Calman require a model of state of the asynchronous machine.

In this study, we present a general model of the asynchronous machine in the space of state in an arbitrary reference frame having for variable of state: The stator current and rotor flow. Thanks to the technique of orientation of rotor flow, this model can be reduced. A comparative study of the complete model and small-scale model are presented in this research. The alternatives linear and nonlinear as well as the possibility of estimate of rotor resistance are also discussed.

MODELING OF THE ASYNCHRONOUS MACHINE

The induction motor is a nonlinear and nonstationary system. The complexity of its model can be simplified by using the transformation of Park and the technique of the orientation of flux. Various models exist in the literature. The model in the space of state of the induction motor in an arbitrary reference mark (initial) is given by (Blaschke, 1992):

$$\frac{d}{dt} \Psi = \Omega \Psi - RI + I_0 U \quad (1)$$

$$\Psi = L_M I \quad (2)$$

Where:

$$\Psi = [\Psi_s \quad \Psi_r]^T$$

$$I = [i_s \quad i_r]^T$$

$$U = [u_s \quad u_r]^T$$

With:

Ψ = The vector of flux.

I = The vector of current.

U = The vector of voltage.

Matrices Ω , R , I_0 and L_M are defined by:

$$\Omega = \begin{bmatrix} \Omega_a & 0_2 \\ 0_2 & \Omega_{ar} \end{bmatrix}, \quad \frac{d}{dt} \begin{pmatrix} i_s \\ \Phi_r \end{pmatrix} = \begin{bmatrix} a_{11} & a_{12} \\ -R_s & \Omega_a \end{bmatrix} \begin{pmatrix} i_s \\ \Phi_r \end{pmatrix} + \begin{bmatrix} b_{11} \\ I_2 \end{bmatrix} u_s \quad (4)$$

With:

$$\Omega_a = \begin{bmatrix} 0 & \omega_a \\ -\omega_a & 0 \end{bmatrix}, \quad \frac{d\omega_r}{dt} = \frac{1}{J} p (T_e - T_l) \quad (5)$$

$$\Omega_{ar} = \begin{bmatrix} 0 & (\omega_a - \omega_r) \\ -(\omega_a - \omega_r) & 0 \end{bmatrix}, \quad T_e = p i_s^T \begin{bmatrix} 0 & -1 \\ 1 & 0 \end{bmatrix} \Phi_s \quad (6)$$

and:

$$R = \begin{bmatrix} R_s & 0_2 \\ 0_2 & R_r \end{bmatrix}, \quad \begin{pmatrix} i_r \\ \Phi_r \end{pmatrix} = \begin{bmatrix} -M^{-1}L_s & M^{-1} \\ (M - L_r M^{-1}L_s) & L_r M^{-1} \end{bmatrix} \begin{pmatrix} i_s \\ \Phi_s \end{pmatrix} \quad (7)$$

With:

$$R_s = \begin{bmatrix} r_s & 0_2 \\ 0_2 & r_s \end{bmatrix}, R_r = \begin{bmatrix} r_r & 0_2 \\ 0_2 & r_r \end{bmatrix},$$

$$L_M \begin{bmatrix} L_s & M \\ M & L_r \end{bmatrix} \text{ with } L_s \begin{bmatrix} l_s & 0_2 \\ 0_2 & l_s \end{bmatrix},$$

$$L_r = \begin{bmatrix} l_r & 0_2 \\ 0_2 & l_r \end{bmatrix}, M = \begin{bmatrix} m & 0_2 \\ 0_2 & m \end{bmatrix},$$

and finally

$$I = \begin{bmatrix} I_2 & 0_2 \\ 0_2 & 0_2 \end{bmatrix}$$

The lemma of matrix inversion is used to simplify calculations and facilitate the transformation of the various dynamic models of the asynchronous machine. Let's have, the expression of the inversion of L_M

$$L_M^{-1} = \begin{bmatrix} (L_s - M L_r^{-1} M^T)^{-1} \\ -(L_{sr} - M L_r^{-1} M^T)^{-1} M L_r^{-1} \\ -(L_r - M^T L_s^{-1} M)^{-1} M^T L_s^{-1} \\ (L_r - M^T L_s^{-1} M)^{-1} \end{bmatrix} \quad (3)$$

According to the reference marks of reference and choice's of the variables of different state models are possible (Wamkeue and Kamwa, 1999). Among these models, we consider the case where the stator current and rotor flow are the variables of state. Thus, the model is written:

The parameters of the matrix of evolution are:

$$a_{11} = \Omega_{ar} + (M - L_r M^{-1} L_s)^{-1} (R_r M^{-1} L_s + L_r M^{-1} R_s)$$

$$a_{12} = (M - L_r M^{-1} L_s)^{-1} [(\Omega_a L_r - R_r) M^{-1} - L_r M^{-1} \Omega_a]$$

$$\text{et } b_{11} = -(M - L_r M^{-1} L_s)^{-1} L_r M^{-1}$$

Note: The case of the nonlinear model can be obtained by regarding the number of revolutions as an additional variable of state.

TECHNIQUE OF ESTIMATE OF STATE

Let us have a continuous system described by the equation of deterministic state as follows:

$$\dot{x}(t) = Ax(t) + Bu(t), \quad (8)$$

$$\dot{y}(t) = Cx(t) + Du(t), \quad (9)$$

Where $u(t)$, $y(t)$ and $x(t)$ are vectors of dimension m , L and n which, respectively represent the control, the measured output and the state of the system. Matrices A , B , C and D are constant matrices of suitable size (Bensaker, 1999). As generally, the state is not accessible, the objective of an observer consists in estimating this state by a variable which we will note $\hat{x}(t)$. This estimate is carried out by a dynamic system whose output will be precisely $\hat{x}(t)$ and the input will be consisted of the whole of information available, i.e., $u(t)$ and $y(t)$.

The structure of an observer is of the form:

$$\dot{\hat{x}}(t) = A\hat{x}(t) + Bu(t) + L(y(t) - \hat{y}(t)), \quad (10)$$

$$\hat{y}(t) = C\hat{x}(t) + Du(t), \quad (11)$$

Where appears clearly on one hand the corrective term $y(t) - \hat{y}(t)$, according to the error of rebuilding of the output, on the other hand, the profit of correction (L), called profit of the observer which one must determine.

This structure can be written in the following equivalent form:

$$\dot{\hat{x}}(t) = (A - LC)\hat{x}(t) + (B - LD)u(t) + Ly(t) \quad (12)$$

If one considers the error in estimation: $\tilde{x}(t) = x(t) - \hat{x}(t)$, then one obtains

$$\dot{\tilde{x}}(t) = (A - LC)\tilde{x}(t) \quad (13)$$

In this case, a great freedom is left with the choice of the eigenvalues, but in practice one chooses a dynamics of error faster than that of the process in the case of an observation in open loop or than that desired in closed loop (Metatla *et al.*, 2003). However, one cannot take them infinitely large for two essential reasons:

- One can use only realizable profits.
- The increase in the band-width of the reconstructor does not make it possible any more to neglect the noises which become dominating in high frequency.

The physical complexity of the asynchronous machines is related to the electromagnetic interactions between the stator and the rotor. The sizes of state or output used for the development of the order or the monitoring of the motorized systems are often difficult to reach for technical reasons or problems from cost (Bensaker *et al.*, 2004). Therefore, It is necessary to determine starting from the already measured sizes (current, tension...), without using dedicated sensors.

They can be reconstituted by traditional estimators used in open loop or observers correcting in closed loop the estimated variables.

The technique of the estimators rests on the use of a representation of the machine in the form of state defined in the reference mark of Park. In steady operation (static estimator) or transient (dynamic estimator), they are obtained by direct resolutions of the equations associated with the model.

For using a system in a chain of control it is first of all necessary to study its conditions of observability and commandability. These two concepts use also the model of state of the asynchronous machine.

APPLICATION OF THE OBSERVERS OF STATE WITH THE MONITORING

In addition to the rebuilding of the state to work out an control by return of state, we will see here another significant application of the observers in control, detection and diagnosis of the failures (Dehay, 1996) in the electric machines. In this optics, one uses the observer to generate residues allowing to working out a decision in a stage of monitoring of the system during the appearance of the disturbances or the defects (Holtz, 2002). The variables which act on the system cannot be measured; therefore the objective of the observer consists in building residues which, according to cases, must be sensitive to the defects and insensitive with the disturbances.

In all the methods of detection of the failures suggested in the literature (Pana, 1999; Bodson and Chiasson, 2002), one must take one or more signals to treat them, analyze them and conclude, with certainty, if there is a failure or not.

With this intention, four elementary signals can be taken. It is about the stator current, of the radiating flux of the machine, the vibrations number of revolutions. But in our case, it is enough to measure the stator current, since it is a diagnosis without sensors or more exactly a diagnosis with a minimum of sensors.

The control and monitoring principle without sensors is given by Fig. 1.

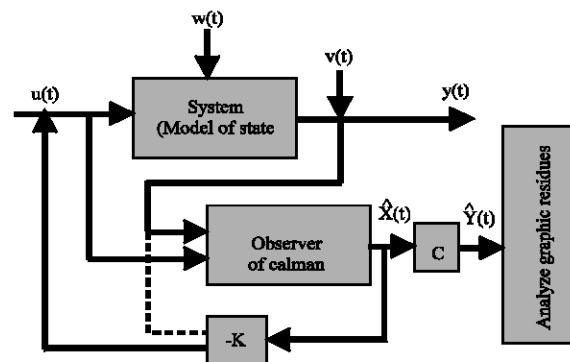

Fig. 1: Principle of the observation, controls, surveillance

DIGITAL SIMULATION

To highlight the performances of the suggested technique of monitoring we consider an induction motor having the characteristics (Appendix).

Simulation consists by studying the dynamic performances of the asynchronous machine in the space of state by using software MATLAB to see the

possibilities of detection without sensor. In this we have the results of simulation of the healthy model and the failing model. Indeed, 2-10, present the variation of the sizes of state of the machine with complete rate and steady operation shown in Fig. 2-5.

Figure 6 and 7 show the signature of phaseshift on the curve of Lissajou. This signature which enables us to easily determine the nature of defect thanks to the shape of the curve.

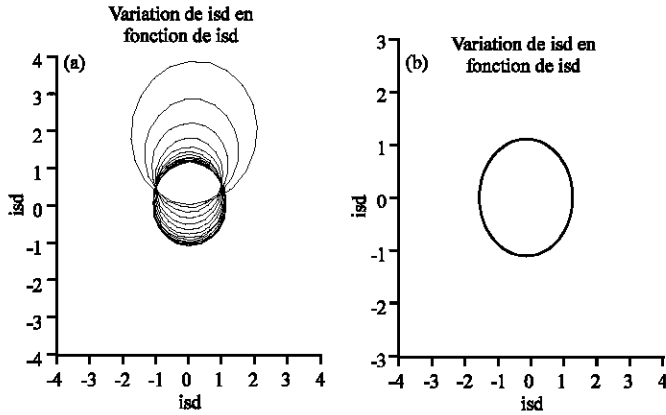

Fig. 2: Variation of the stator currents

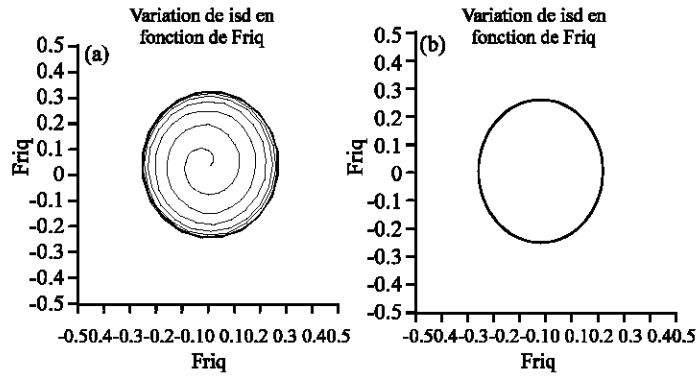

Fig. 3: Variation of rotor flux

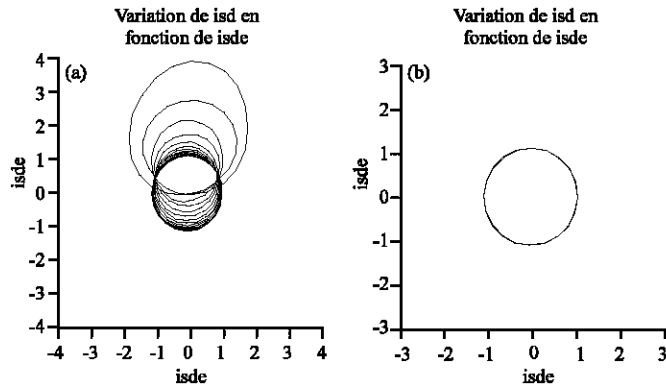

Fig. 4: Variation of the current if the stator estimated

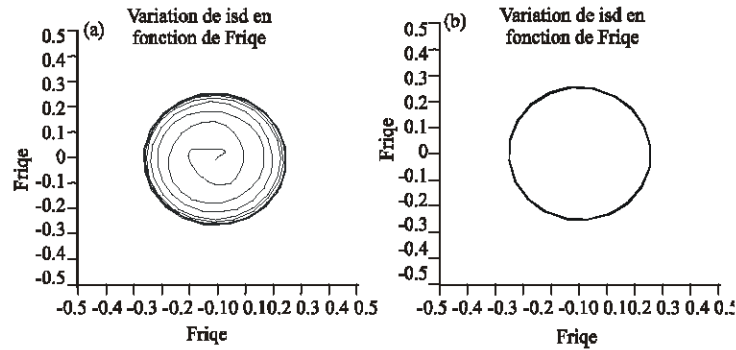

Fig. 5: Variation of fluxes of the estimated

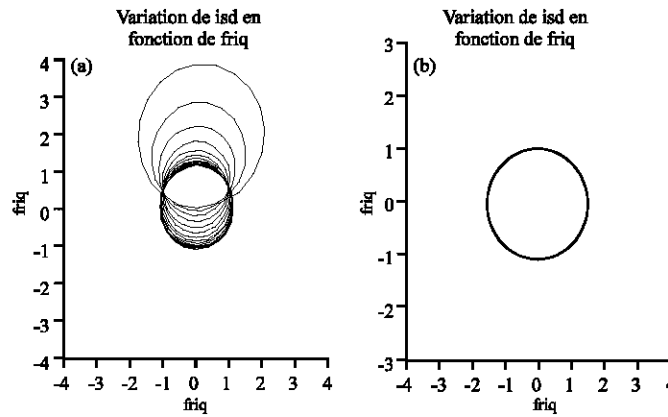

Fig. 6: Variation of the stator currents

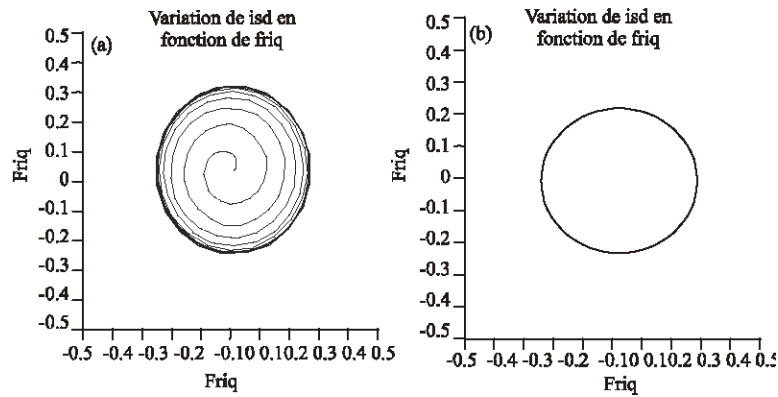

Fig. 7: Variation of stator flux

To this end, it is enough to make recordings of the variables of state estimated of the motor and to make a comparison with the results estimated in the event of failure by using the analysis of the curves of Lissajou or the spectral analysis shown in Fig. 8.

One notices, that these tests represent only the results obtained by the analysis of the current and

estimated flux, shown in Fig. 9. However, the possibility of analyzing other variable as the electromagnetic couple is also possible.

One can also make an spectral analysis by using the transform of fourrier of each vector of state, which gives the spectrum in the healthy and failing case.

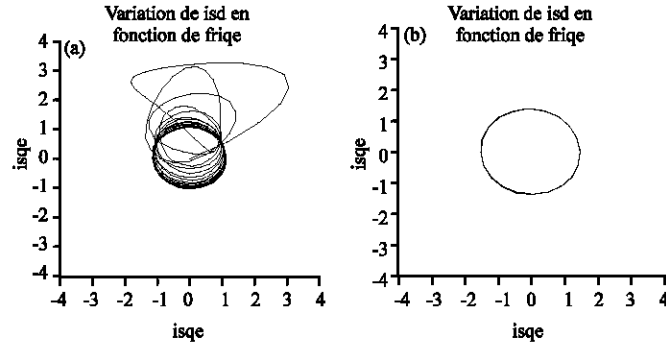

Fig. 8: Variation of the estimated stator currents

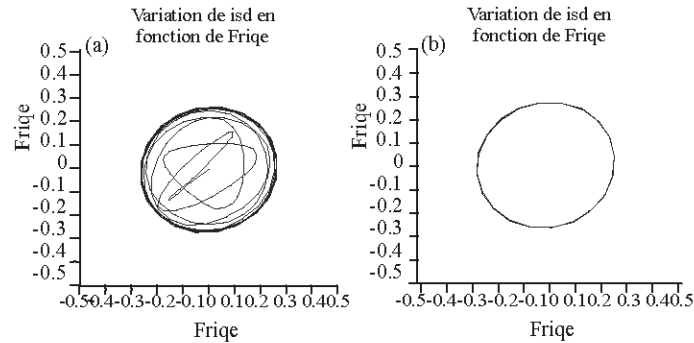

Fig. 9: Variation of estimated rotor flux

APPENDIX

$$f_r = 50\text{Hz}, U = 220\text{V}, \omega_m = 146.6\text{rd/s}, r_s = 0.63\Omega,$$

$$r_r = 0.4\Omega, l_s = 0.097\text{H}, l_r = 0.091\text{H},$$

$$m = 0.091\text{H}, \sigma = 1 - \frac{m^2}{l_s l_r} = 0.0682, T_r = 0.2275,$$

$$T_s = 0.1539, f = 1\text{Ns/rd}, J = 0.22\text{kgm}^2.$$

CONCLUSION

The industrial systems has become increasingly sophisticated with on one hand the numerical systems of control and on the other hand the technological solutions for distributed and hierarchical data processing. Because of these evolutions, the establishment of algorithms of diagnosis within industrial facilities became possible. So that the methods of diagnosis can apply to complex systems, it is crucial to conceive adapted methodologies and technologies. The systems of diagnosis must be conceived to support many procedures of test starting ones the others and often functioning in parallel and different places. On a

higher level, the results of the test of detection must be analyzed to lead to a reliable holding diagnosis.

REFERENCES

- Blaschke, F., 1992. The principle of field orientation as applied to the new transvektor closed loop control system for rotating-field machines. Siemens Review, No. 5.
- Bensaker, B., 1999. Parameter estimation for an electromechanical system via a continuous-time model. Proceedings of the 3rd international symposium on advanced electromechanical motion systems. University of Patras, Greece, pp: 759-762.
- Bensaker, B., A. Maouche, A. Metatla and H Kherfane, 2004. Sensorless control and monitoring of induction motor. Second ational symposium of hydrocarbons and chemistry, Ghardaia,
- Bodson, M. and J. Chiasson, 2002. Comparison of sensorless speed estimation methods for induction motor control. Proc. ACC., pp: 3076-3081.

- Dehay, G., 1996. Application des moindres carrés récursifs à l'estimation temps réel des paramètres de la machine asynchrone. Thèse de Doctorat d l'UTC, France.
- Holtz, J., 2002. Sensorless control of induction motor drives. Proc. IEEE., 90, 8, pp: 1359-1394.
- Metatla, A., A. Maouche and B. Bensaker, 2003. Application des techniques d'observation à la commande sans capteur du moteur à induction. SNSEM Université de Annaba,
- Pana, T., 1999. Speed sensorless induction drive system for direct driven electrical vehicle. Proceedings of 3rd International symposium on Advanced electrical motion systems. Patras, Greece, pp: 829-834.
- Wamkeue, R. and I. Kamwa, 1999. Generalised state space modelling of induction machines having multiple rotor circuits. Proceedings of 3rd international symposium on advanced electromechanical motion systems. Patras, Greece, pp: 61-66.