

## **Investigation and Evaluation of Voltage Drops: A Case Study of Guinness and Ikpoba Dam Injection Substations**

M.S. Okundamiya, O.S. Udeozor and O.J. Imade

Department of Electrical and Electronic Engineering, Ambrose Alli University,  
P.M.B. 14, Ekpoma, Nigeria

**Abstract:** This study presents an in-depth analysis and evaluation of the amount of voltage drops in houses along selected streets in Benin city, which was restricted to Power Holding Company of Nigeria (PHCN). The study embraced the readings of the transformer supplied voltage, house-to-house received voltage, currents, power consumption in each house using clip-on metre, while the distance of each house from the transformer supplying, the street was obtained using measuring tape. The results obtained shows that if consumers are to receive a reasonable supplied voltage for efficient operation of their appliances the distance of the consumer's service cable at the farthest end from the transformer should not exceed 400 m.

**Key words:** Voltage drops, substation, injection substation, consumers load distance, power distribution

### **INTRODUCTION**

In modern day world of engineering, voltage and current are inevitable to homes and industries. In houses where lighting gadgets are often used than industries, there is likelihood that low voltage can flow through these gadgets. The effects of excess voltage drop (Kopp, 2008; Lansing, 2008) include:

- Low voltage to the equipment being powered, causing improper, erratic, or no operation-and damage to the equipment.
- Poor efficiency and wasted energy.
- Excess heat at a high resistance connection/splice may result in a fire at high ampere loads.

The continuous breaking down of consumers electrical appliances, which occur in all season of the year has been a major concern. A consumer is defined as any person or group of persons who use the electrical power from the PHCN to meet his/their daily needs in any form. There are 3 types of consumers-industrial, commercial and residential. Consumers are connected to the grid through the LTS of any of the substations. For purpose of measurement, our investigation was restricted only to commercial and residential consumers.

Much has been done on the causes of voltage drops and power outages (Ramsey, 2006; Kopp, 2008; Osahenvenmwen and Omorogiuwa, 2009). However, such

work were limited to resistance in the cable (conductor), use of substandard conductors, poor electrical ground surface, plain loose connections, current flowing through the conductor, faulty equipment and faults in the power system, vandalization of equipment, inadequate planning, overloading of the transformer, to mention but a few. This study highlights the causes of voltage drops on transformer supply voltage by investigating and evaluating the effects of load distance on consumers received voltage for selected consumers in various homes in Benin city that are supplied by these transformers.

**Voltage drops:** Voltage drops (Kopp, 2008) in an electrical circuit normally occur when current is passed through the cable. Cables used to distribute power throughout the distribution (or transmission) lines, have resistance associated with them. The longer the cables the larger the resistance and the larger the resistance the greater the associated voltage drops. Hence, voltage drops across the cable is unavoidable if it has to carry current. From Ohm's law:

$$V = IR \text{ (Volts)} \quad (1)$$

The voltage dropped,  $V_D$  between 2 terminals (source,  $V_S$  and recipient,  $V_R$ ) is given by:

$$V_D = V_S - V_R \text{ (Volts)} \quad (2)$$

**Per unit voltage drops:** It is the ratio of voltage drop to the supplied voltage i.e.,

$$p.u = \frac{V_s - V_R}{V_s} \quad (3)$$

When expressed as a percentage, it becomes

$$\text{Percentage of p.u} = \frac{V_s - V_R}{V_s} \times 100 \quad (4)$$

**Causes of voltage drops:** Voltage drop is caused either by resistance in the conductors (connections) leading to the electrical load or use of substandard cables (not heavy enough gauge for the length of the run). There are many causes of resistance in the conductor path. The 4 fundamental causes (Lansing, 2008) of voltage drops are:

- Material-Copper is a better conductor than aluminum and will have less voltage drop than aluminum for a given length and cable size.
- Cable Size-Larger cable sizes (diameter) will have less voltage drop than smaller cable sizes (diameters) of the same length.
- Cable Length-Shorter cables will have less voltage drop than longer cables for the same cables size (diameter).
- Current being carried-voltage drop increases on a cable with an increase in the current flowing through the cable.

**Substation:** A substation is a place for assembling equipment in an electric system through which electrical energy is passed for transmission, distribution, interconnection, transformation, conversion or switching (Mehta and Mehta, 2004; Gupta, 2006; Electrical Substation-Wikipedia, 2008). It includes a variety of equipment and accessories. The principal items are transformers, overhead lines, towers or poles, circuit breakers, disconnect switches, bus-bars, shunt reactors, shunt capacitors, current and potential transformers, isolators, feeder pillars, earth mats, 35 mm<sup>2</sup> armoured cables, 100 mm<sup>2</sup> copper wires, electric discs, pole support and control and protection equipment.

Good substation grounding is very important for effective relaying and insulation of equipment; but the safety of the personnel is the governing criterion in the design of substation grounding.

**Injection substation:** It is a substation (Wikianswers, 2008), where a higher voltage is stepped down to a lower voltage, especially for transmission in a densely

populated area. The transformer involved is often in the MVA range, so that the output can serve a wide area, or large consumers. The capacity of most injection substation ranges from 2.5-15 MVA depending on the feeder pillars on the injection substation. The ratings of Ikpoba Dam and Guinness Substation are 7.5 and 15 MVA, respectively. There are units in the feeder pillars where streets are fed from and in turn houses are fed. The transformer used here is star-star with 3 phase 3 wire system.

**Distribution substation:** These are located near to the end-users. Distribution substation (Distribution Substation-Electric Power eTool, 2008) transformers change the sub transmission voltage to lower levels for use by end-users. In this case, the transformer handles 11/0.415 or 6.6/0.415 kV rating with 11 or 6.6 kV to the (HTS) and 0.415 kV from the (LTS). Some distribution substations have 33/0.415 kV step down transformers. This type of distribution substation is the modified substation mostly used by many houses. The transformer used here is star-delta with 3 phase 4 wire system. The distribution transformers are found in the distribution substations where the 11 kV line voltage is dropped to 0.415 kV except where they are connected to the 3 phase 4-wire network. Residential and commercial consumers who are connected to a single phase have approximately 0.240 kV (line to neutral) distributed to them for active usage. All the voltages on the HTS or the LTS are across the RYB of each of the substation.

**Feeder pillars:** The LTS of the distribution transformer is connected to the feeder pillar. The feeder pillar is a metallic large box where the 0.415 kV line-to-line voltages are connected to streets from which consumers tap their single-phase (0.240 kV line to neutral) for usage. Inside the feeder pillar are bus bars, which are connected to each other through a tiny but thick metallic wire, called fuse. The bus bars are arranged such that the 3-phase 4 wire 0.415 kV is splintered into several units. The main 0.415 kV from the LTS of the transformers is connected through the fuse to the auxiliary 0.415 kV from which streets are fed. Depending on the types of feeder pillar, units are created for the distribution of the 0.415 kV line. There are 2-way feeder pillar from which 2, 3, or 4 units are generated to feed 2, 3, or 4 streets. A single phase is gotten if only one line and neutral is connected and its value is 0.240 kV. A unit is terminated in the next distribution substation should it not be able to satisfy the number of buildings connected to it. If the consumers load is higher than the distribution load, there is bound to be overheating on the lines because the ambient temperature will be exceeded

thus, resulting in the overheating of the fuses in the feeder pillar and finally causing a total dark out of the street.

**Circuit breakers:** A circuit breaker is a mechanical device designed to close or open contact members (Gupta, 2006) thus, closing or opening an electrical circuit under normal or abnormal conditions. Their names are derived from the type of medium used in controlling and extinguishing the alternating current produced during opening and closing of contacts. They are used to protect transformers, generators and other equipment under abnormal conditions. Some circuit breakers can be operated manually but for high voltage and heavy current, they are generally springs, electro magnetically assisted or remote controlled. In any circuit breaker (Usifo, 2003; Gupta, 2006; Shepherd *et al.*, 1970) provision must be made to extinguish any arc forming between contacts as they open and also to ensure that the arc does not reform. This is particularly important when heavy currents are passing at high voltages especially under fault conditions. The arcs are formed, as the contacts open, thereby ionising insulating medium. This tends to maintain the arc and causes it to be resisted at a comparatively low voltage, thus, the main feature of a circuit breaker is to extinguish the arc quickly by increasing the length of its path and to display the ionised gases by replacing them with a cool insulating medium.

**Isolators:** They are essentially knife edge switches (Mehta and Mehta, 2004) designed to open a circuit under no load condition. These are forms of circuit breakers, which are manually operated. They are basically high voltage switches, which provide clear visual evidence that the circuit is opened as this is of great importance to the safety of personnel's attending to the electrical installation. It is also used to isolate electrical equipment or network such as to isolate a faulty street (distribution substation) from the feeder pillar (injection substation), without disturbing other streets (distribution substation). They are usually positioned along high-tension lines at strategic positions.

**Earth mat:** It is a netted mat of high dense conductors of about 5 strands. The standard area of an earth mat is 1 m<sup>2</sup>. Each edge of the earth mat is connected to the lightning arrester on top of the electric pole and act as the neutral in the substation. It reduces the overall grounding resistance (Gupta, 2006) hence, it helps to conduct electric signals from the lightning and fault current to the ground. It is the earth terminal of the pole circuit. The earth mat is buried at about 1.5 m below the earth surface. But, before

this is done, materials like wood charcoal are poured into the hole to decrease the electric potential of the earth at this region. More than two earth mats are normally buried in a substation. Standard earthing arrangements for HV earth mats (Wareing, 2005) now consist of buried conductor of at least 70 mm<sup>2</sup> connected to three earth rods situated at the points of a 6 m triangle.

**Earth electrode:** An earth electrode is a corrosion resistant metal rod, which makes effective contact with the general mass of earth. A common type consists of a small diameter copper rod, which can be easily driven to a depth of 6 m, or more into ground reasonably free of stones or rock. The soil remains practically undisturbed and in very close contact with the electrode surface. Since resistivity is lower in the deeper strata of earth and not very affected by seasonal conditions, deep driving of rods gives a good earthing.

**Lightning arrester:** It is a protective device which conducts the high voltage surges on the power system to the ground (Mehta and Mehta, 2004) installed in transmission lines, houses and injection substations at higher altitude to absorb the current that accompany lightning. It is necessary to protect the transformer from the excess current, which could damage the transformer and some other equipment in the substation if left unchecked. Lightning arrester acts similar to a safety valve. When a high voltage wave reaches the lightning arrester, it sparks over and provides a conducting path of relative low impedance between the line and earth, so the resulting current flows to the earth. Some of the various types of lightning arresters (surge diverters) commonly used today (Usifo, 2003) are rod gap, sphere gap, horn gap, impulse lightning arrester with protective gap, electrolytic type of lightning arrester, lead oxide arrester, oxide film arrester, expulsion (or tube type) arrester, over-voltage arrester and valve type (Thyrite) arrester. The actual protective zone (Wareing, 2005) of a surge arrester is dependent on the number of overhead line feeders, local lightning strike density and current, lightning impulse protection level of the arrester, span length of the incoming line, acceptable failure rate for the station and the overhead line outage rate for the first kilometre of line in front of the station. The protective zone increases with increasing difference between the withstand voltage and the protection level, improved shielding to the overhead line and reduced tower surge impedance.

Effective shielding of the substation and nearby overhead line feeders will help to reduce the rate-of-rise of the voltage surge.

Figure 1 and 2 shows the distribution diagram of Guinness and Ikpoba Dam injection substations.

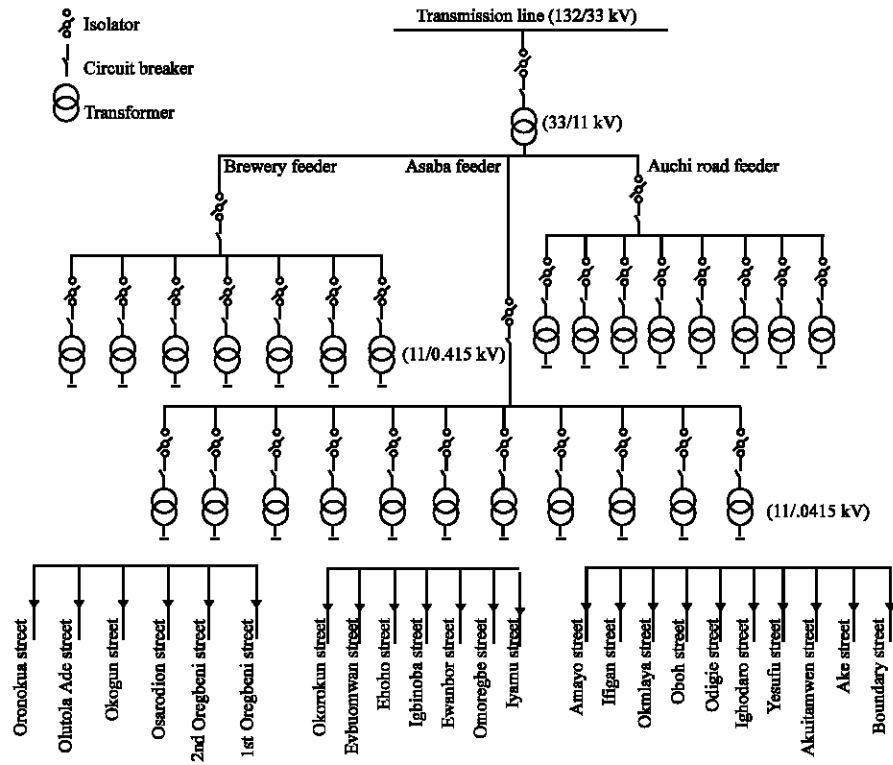

Fig. 1: Distribution diagram of Guinness Injection Substation

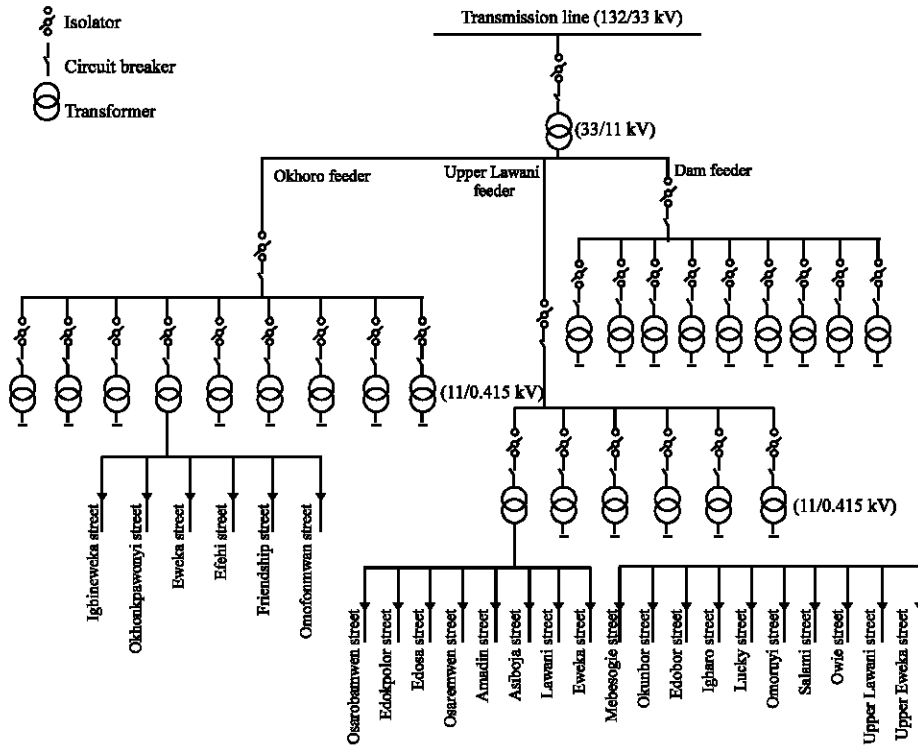

Fig. 2: Distribution diagram of Ikpoba Dam Injection Substation

Table 1: Distance and voltage readings for each of three selected transformers connected to the injection substation

Injection substation	Approx Distance D (m)	Consumer received voltage $V_R$ (V)			Voltage drops $V_D$ (V)			Percentage/Unit voltage drop p.u (%)		
		T <sub>1</sub>	T <sub>2</sub>	T <sub>3</sub>	T <sub>1</sub>	T <sub>2</sub>	T <sub>3</sub>	T <sub>1</sub>	T <sub>2</sub>	T <sub>3</sub>
Guinness	40	220.0	220.0	220.0	0.0	0.0	0.0	0.0	0.0	0.0
	100	217.0	218.0	219.0	3.0	2.0	1.0	1.4	0.9	0.5
	160	215.0	216.0	218.0	5.0	4.0	2.0	2.3	1.8	0.9
	220	214.0	215.0	217.0	6.0	5.0	3.0	2.7	2.3	1.4
	280	212.0	212.0	215.0	8.0	8.0	5.0	3.6	3.6	2.3
	340	210.0	209.7	210.0	10.0	10.3	10.0	4.5	4.7	4.5
	400	209.2	208.5	209.0	10.8	11.5	11.0	4.9	5.2	5.0
	460	202.0	204.0	200.0	18.0	16.0	20.0	8.2	7.3	9.1
	520	196.0	198.0	195.0	24.0	22.0	25.0	10.9	10.0	11.4
	580	186.0	180.0	188.0	34.0	40.0	32.0	15.5	18.2	14.5
	640	169.0	171.0	170.0	51.0	49.0	50.0	23.2	22.3	22.7
	700	154.0	156.0	155.0	66.0	64.0	65.0	30.0	29.1	29.5
	900	139.0	138.0	140.0	81.0	82.0	80.0	36.8	37.3	36.4
Ikpoba Dam	40	215.0	216.0	217.6	0.0	0.0	0.4	0.0	0.0	0.2
	100	214.5	216.0	216.4	0.5	0.0	1.6	0.2	0.0	0.7
	160	213.0	215.0	215.0	2.0	1.0	3.0	0.9	0.5	1.4
	220	212.0	213.5	213.0	3.0	2.5	5.0	1.4	1.2	2.3
	280	210.0	211.0	210.9	5.0	5.0	7.1	2.3	2.3	3.3
	340	207.0	208.0	210.0	8.0	8.0	8.0	3.7	3.7	3.7
	400	204.5	205.6	206.8	10.5	10.4	11.2	4.9	4.8	5.1
	460	201.0	201.4	202.0	14.0	14.6	16.0	6.5	6.8	7.3
	520	197.0	197.1	192.0	18.0	18.9	26.0	8.4	8.8	11.9
	580	190.0	192.0	191.6	25.0	24.0	26.4	11.6	11.1	12.1
	640	179.0	184.0	182.0	36.0	32.0	36.0	16.7	14.8	16.5
	700	172.0	177.0	180.3	43.0	39.0	37.7	20.0	18.1	17.3
	900	160.0	158.0	161.0	55.0	58.0	57.0	25.6	26.9	26.1

**MATERIALS AND METHODS**

This investigation was carried out on two-injection substations-Guinness and Ikpoba Dam Injection Substations and three of the connected transformers to each injection substation as a case study. For each of these injection substations and the three transformers connected, voltage and current readings were taken from houses supplied by these transformers that using clip-on metre and their respective distances with a measuring tape. Readings taken from selected houses were used to evaluate the voltage drops and their percentage per unit values. These measurements were carried out between 7:00 and 8:00 pm daily between January and July 2008 and the average daily received voltages, voltage drops and percentage per unit voltage drops obtained at approximate distances shown in Table 1.

**RESULTS AND DISCUSSION**

The results obtained from the measured voltage at the consumer terminal along with their corresponding distance and evaluated voltage drops and percentage per unit values is shown in Table 1. For Guinness Injection Substation, the transformer supplied voltages are:

$$V_{s1} = V_{s2} = V_{s3} = 220 \text{ V} \tag{5}$$

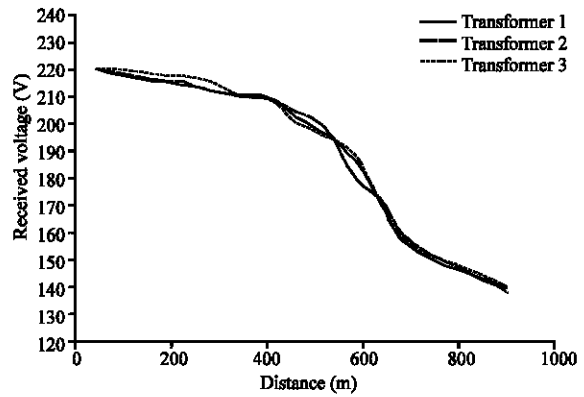

Fig. 3: The graph of consumer received voltages against measured distances for Guinness Injection substation

While, for Ikpoba Dam injection substation, the transformer supplied voltages are:

$$V_{s1} = 215 \text{ V} \tag{6}$$

$$V_{s2} = 216 \text{ V} \tag{7}$$

$$V_{s3} = 218 \text{ V} \tag{8}$$

The graphs of consumer received voltages against measured distances for Guinness and Ikpoba Dam

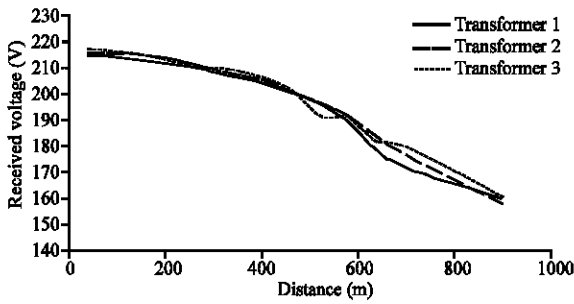

Fig. 4: The graph of consumer received voltages against measured distances for Ikpoba Dam Injection Substation

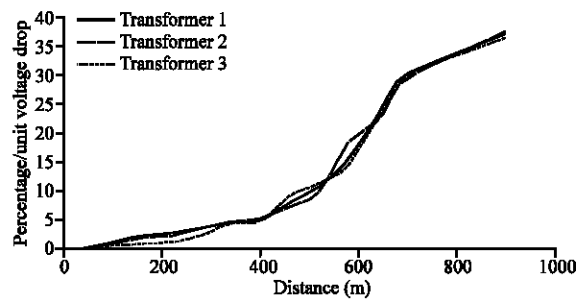

Fig. 7: The graph of consumer percentage per unit voltage drops against measured distances for Guinness Injection Substation

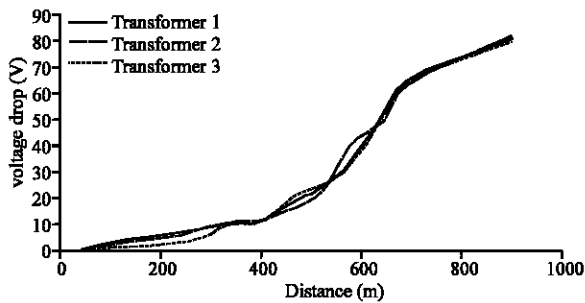

Fig. 5: The graph of consumer voltage drops against measured distances for Guinness Injection Substation

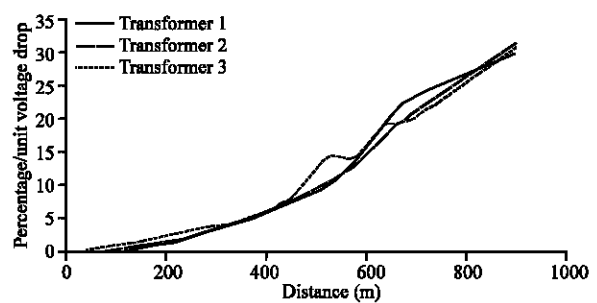

Fig. 8: The graph of consumer percentage per unit voltage drops against measured distances for Ikpoba Dam Injection Substation

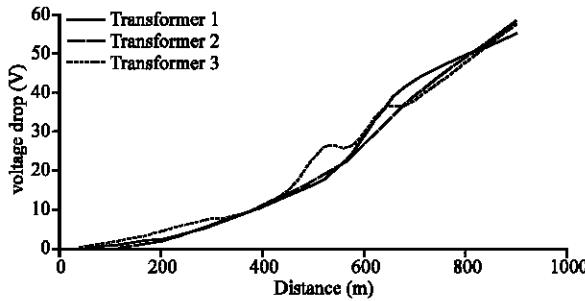

Fig. 6: The graph of consumer voltage drops against measured distances for Ikpoba Dam Injection Substation

injection substations are shown respectively in Fig. 3 and 4, while Fig. 5 and 6 show the graph of consumer voltage drops against measured distances. The percentage per unit voltage drop against distance are shown in Fig. 7 and 8.

From Fig. 3 and 4, the farther the distance of the consumer from the transformer the lower the consumer received voltage and hence, the higher the voltage drops (Fig. 5 and 6). The consumers received voltages for the 6 transformer under investigation at a distance exceeding

400 m will result to a voltage drop exceeding 5% of the supplied value which is unreasonable as it can affect effective operation of electrical appliances since most electrical designs are done in accordance with the requirements in 210.19 (A) (1) and Fine Print Note (FPN) No. 4. A footnote (NEC 210-19 FPN No. 4) in the National Electrical Code states that a voltage drop of 5% at the furthest receptacle in a branch wiring circuit is acceptable for normal efficiency. For the 220 (216) volt circuit considered, this means that there should be no more than 11 (10.8) Volt drop or less than 209 (205.5) volts received at the furthest outlet when the circuit is fully loaded. For the voltage drop within the areas under investigation to obey the NEC recommendation the maximum cable distance at farthest consumer outlet should not exceed 400 m. This investigation has also reveals that use of multiple linking conductors of different sizes and qualities in distribution or transmission lines enhances voltage drops.

### CONCLUSION AND RECOMMENDATIONS

The longer, the cable distance the higher the voltage drop. For effective supply of voltage to consumer for

efficient operation of appliances the distance of the consumer cable from the transformer should not exceed 400 m. It is also recommended that proper monitoring of load connected to transformers, use of standard sizes and qualities of conductor to distribute or transmit power from the transformer, proper planning and load forecasting will reduce voltage drop.

#### REFERENCES

- Electric Power eTool-Distribution Substation, 2008  
[http://www.osha.gov/SLTC/etools/electric\\_power/glossary.html#Distribution](http://www.osha.gov/SLTC/etools/electric_power/glossary.html#Distribution).
- Electrical Substation-Wikipedia, 2008. The free encyclopedia  
[http://en.wikipedia.org/w/index.php?title=Electrical\\_substation&oldid=245392420](http://en.wikipedia.org/w/index.php?title=Electrical_substation&oldid=245392420).
- Gupta, J.B., 2006. A Course in Power Systems. 10th Edn. KATSON Books, Darya Ganj, New Delhi-110001, India. Part III, pp: 131, 133-136, 472, 513.
- Kopp, H.P., 2008. Frequently asked questions-voltage drop. Technical Articles SureTest. <http://www.psihq.com/iread/faqvolt.htm>.
- Lansing, 2008. Fundamentals of electricity. <http://lansing.apogee-net/foe/frvc.asp>.
- Mehta, V.K. and R. Mehta, 2004. Principles of Power System. 4th Edn. S. Chand and Co. Ltd., Ram Nagar, New Delhi-110 055, India, pp: 560, 569-570, 577. ISBN: 81-219-2496-0.
- Osahenvenmwun, A.O. and O. Omorogiuwa, 2009. Wind Electric Power System in Edo State (Ekpoma), IJEPE. Medwell J. Pak., 3 (1): 13-18.
- Ramsey, T., 2006. Testing voltage drops. Ramsey Consulting Group Inc. [http://www.mecp.com/newsletter/6-06\\_voltage.htm](http://www.mecp.com/newsletter/6-06_voltage.htm).
- Shepherd, J., A. H. Morton and L. F. Spence, 1970. Higher Electrical Engineering. 2nd Edn. Pitman Publishing Ltd., Avon, London, pp: 558-567. ISBN: 0-273-40063-0.
- Usifo, O., 2003. Electrical High Voltage Engineering. 1st Edn. ECAS Nig. Ltd., Lagos, Nigeria, pp: 41-52, 134. ISBN: 978-36460-4-8.
- Wareing, B., 2005. Wood Pole Overhead Lines, IET, Chapter 10 and 18 ISBN: 9780863413568. <http://iee.books24x7.com/viewer.asp?bookid=15534&chunkid=0231218933>.
- WikiAnswers, 2008 Injection substation [http://wiki.answers.com/Q/What\\_is\\_an\\_injection\\_substation&alreadyAsked=1](http://wiki.answers.com/Q/What_is_an_injection_substation&alreadyAsked=1). Q & A the Wiki way.