

## The Structuring of Electro Mechanic Conversion Drive Chain

Hassainia, S., <sup>1</sup>H. Abbassi and S. Kechida  
 Laboratoire d'automatique et d'informatique de Guelma BP 401  
<sup>1</sup>Laboratoire d'automatique et signaux Annaba

**Abstract:** We are interested in modelling of electromechanical conversion chains. Such chain is made up of an electric source of energy, an electric converter followed by an electric machine, a mechanical converter and finally of a mechanical source which comes to charge the system. The order of such chains is an ambitious challenge for it must answer the management of the energy transformation which takes place with through the various elements of the chain. Two tools of modelling and representation of such chains are presented, the first is the Causal Informational Graph (GIC) which makes it possible to highlight the various relations of causes for effect and the second the Energetic Macroscopic Representation (EMR) which insists on the principle of action and reaction between the various elements of the system. These tools have a double interest, to initially allow the development of the model for the system then to structure the drive. This work is devoted to the determination of an algorithm of control of an electromechanical conversion chain with induction machine.

**Key words:** Vector control, CIG, induction machine, EMR

### INTRODUCTION

The increasing economic stakes requires increasingly efficient and powerful systems. Electromechanical conversion is thus ensured by increasingly complex electro technical systems using several machine and/or static converters.

The control of such systems is an ambitious challenge because it must answer the management of the energy transformation which takes place through several components in interaction<sup>[1,2]</sup>.

Among the tools developed to have a representation of the ordered action of the energy variables within a system, the Causal Informational Graph (CIG) it is a representation which allows a synthetic description of the relations between the variables of a process according to the concept of cause and effect<sup>[2]</sup>, which contributes to the implementation of a law of ordering of the system. The structure of the order results from the inversion from the graph. Another representation which is the Macroscopic Energy Representation (REM) comes to supplement the Causal Informational Graph (CIG) in order to return the study of the systems complexes progressive by a synthetic vision while respecting causality<sup>[3]</sup>.

After having presented the preliminary definitions of the two formalisms the Causal Informational Graph (CIG) and the Energetic Macroscopic Representation (EMR), an application illustrates these concepts which consists in determining the structure of the ordering

of a an electromechanical conversion chain with induction machine.

**GIC of a process:** The causal informational graph organize the energy variables of an assembly of objects which we have the functional knowledge. It is a question of modelling the process by respecting natural and physical causality with each constitutive object<sup>[4]</sup>.

The graph is made of processors specifying for each object its rigid character (independent of time) or causal character (dependent on time) Fig. 1.

**Principle of inversion:** A methodology of inversion makes possible to easily deduce a structure of law according to the specifications.

The rigid relations are invertible directly Fig. 2a; the causal relations are reversed by the means of a feedback control Fig. 2b because their entries and exits are not interchangeable<sup>[3]</sup>.

A relation feedback control makes it possible to reverse the no reversible relation indirectly but requires an additional entry which is the real exit in order to minimize the variation and to provide the function of tracking.

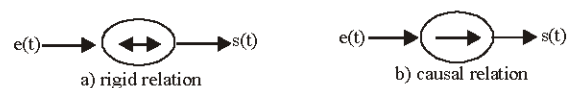

Fig. 1: CIG representation of a processor

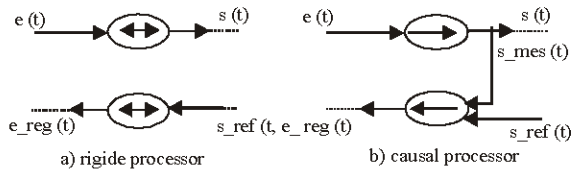

Fig. 2: Inverse of the relation of CIG

**ENERGETIC MACROSCOPIC REPRESENTATION**

The Energetic Macroscopic Representation (EMR) is a condensed CIG whose graph is organized and simplified to highlight the exchange variables of the elements of an energetic conversion<sup>[3]</sup>.

Chain of conversion connects an electric source SE to a mechanical source SM by the intermediary of elements of conversion which are:

- The electric machine ME which ensures an electromechanical conversion.
- The mechanical converter CM which adapts the mechanical energy between the machine and the mechanical source.
- And elements of adaptation. An element of adaptation is characterized by a storage of energy which implies at least a variable of state.

Each one of these elements has vectors of exchange which represent the energy exchanges between the elements according to the principle of the action and the reaction.

On Fig. 3 the electric source produces an action the Use tension which is transmitted towards the mechanical source which answers by a reaction the speed of drive  $\Omega$ , thus one defines an axis of variables of action and an axis of variables of reaction. In an unspecified place of the chain of conversion these variables are dual one of the another<sup>[3]</sup> Each element of conversion has two entries and two exits of power. With respect to the downstream source the element of conversion EC is subjected to a Use action which generates an action exit Ue. In return the element of conversion produces a reaction exit ise which is a modulation of the reaction entry of<sup>[3]</sup>.

Each element of conversion can have a vector of adjustment in order to manage the energy transfer.

**Structure of control deduced from a EMR:** The GIC shows that the process control consists of the inversion of its model. This principle is applied to the EMR in order to deduce from it the structure of control.

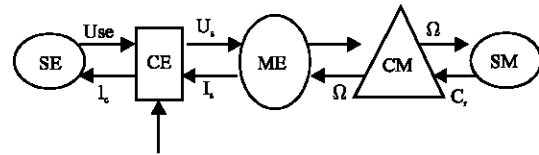

Fig.3: Representation EMR of an electro mechanic conversion chain

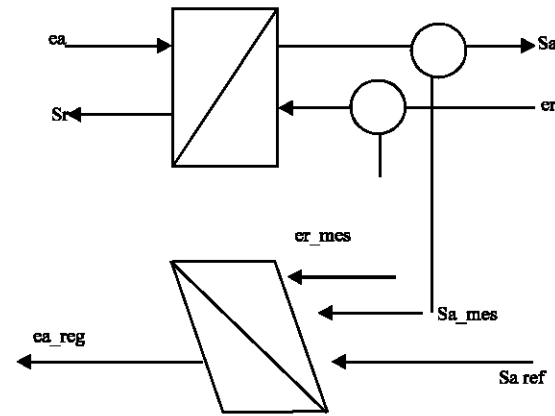

Fig. 4: Inversion of adaption elemnet

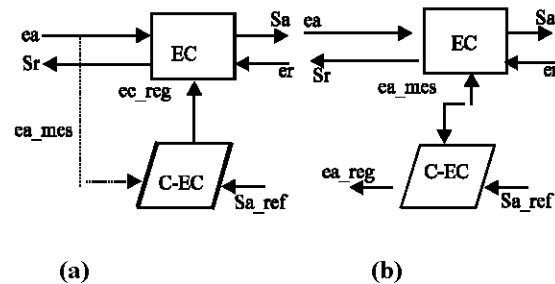

Fig. 5: Inversion of conversion element

**The inversion of an adaptation element:** The Fig. 4 illustrates the macro model resulting from the inversion of measured or to consider it necessary to carry out one asservicement and a compensationthe element of adaptation which reveals two sizes to be

**The inversion of a conversion element:** The Fig. 5 illustrates the macro model resulting from the inversion of conversion element. As Conversion Element (EC.) has three action inputs entries and two reaction outputs ,so we have two manners there of making thus evolve the action output by acting on action or adjustment input. Two solutions of inversion are possible. The first consists in acting on the adjustment input ec\_reg, the action input becomes a disturbance (Fig. 5a). The second makes it possible to define the action input to apply ea\_reg to obtain the output wished action, the adjustment input becomes a disturbance (Fig. 5b).

### APPLICATION

The electromechanical conversion chain considered is represented Fig. 5 in the form of energetic macroscopic representation

In order to work out the structure of control of such chain, it is necessary to seek the principal chain of causality by establishing the model of each component in the form of causal informational graph and to deduce from it thereafter the structure of total order per inversion of each processor of the chain.

- Definition of the sources: The electric source imposes a continuous tension  $U_{SE}$  the mechanical source is compared to the load which involves the machine it imposes a resistive torque.
- Representation of the static inverter: the static inverter is a three-phase inverter in bridge characterized by its function of modulation  $mce$  with:

$$U_{ce} = \begin{bmatrix} Va \\ Vb \\ Vc \end{bmatrix} = mce.U_{se} \quad [1]$$

and

$$mce = 1/3 \cdot \begin{bmatrix} 2 & -1 & -1 \\ -1 & 2 & -1 \\ -1 & -1 & 2 \end{bmatrix} \cdot \begin{bmatrix} f11 \\ f21 \\ f31 \end{bmatrix} \quad [2]$$

$f11, f21, f31$ , constitute the functions of connection of the static switches of the inverter.

Representation of the induction machine:

The induction machine considered is traditional, it makes up of a stator, a rotor with cage; the air-gap is constant. The modelling rests on the traditional assumptions: magnetic circuit unsaturated, effects of notch neglected. To ensure the control in dynamic mode we defined the model of the induction machine in d-q reference

The equations of tension are:

$$\begin{aligned} V_{ds} &= R_s i_{ds} + \frac{d\Phi_{ds}}{dt} - \omega_s \Phi_{qs} \\ V_{qs} &= R_s i_{qs} + \frac{d\Phi_{qs}}{dt} + \omega_s \Phi_{ds} \\ V_{dr} &= 0 = R_r i_{dr} + \frac{d\Phi_{dr}}{dt} - \omega_r \Phi_{qr} \end{aligned} \quad [3]$$

$$V_{qr} = 0 = R_r i_{qr} + \frac{d\Phi_{qr}}{dt} - \omega_r \Phi_{dr}$$

the mechanical equations :

$$J \frac{d\Omega}{dt} + f \cdot \Omega = C_{mec} - Cr \quad [4]$$

$$C_{em} = \frac{M}{L_r} (\Phi_{dr} i_{qs} - \Phi_{qr} i_{ds}) \quad [5]$$

the equations of flows:

$$\begin{aligned} \Phi_{ds} &= L_s i_{ds} + M i_{dr} \\ \Phi_{dr} &= L_r i_{dr} + M i_{ds} \\ \Phi_{qs} &= L_s i_{qs} + M i_{qr} \\ \Phi_{qr} &= L_r i_{qr} + M i_{qs} \end{aligned} \quad [6]$$

the equation of self driving:

$$\begin{aligned} \partial s &= \partial r + \partial \\ \omega s &= \omega r + p\Omega \end{aligned} \quad [7]$$

So an induction machine model can be represented with equations as seen above :

$$\begin{aligned} V_{ds} &= R_s i_{ds} + \sigma L_s \frac{di_{ds}}{dt} + e_{ds} \\ V_{qs} &= R_s i_{qs} + \sigma L_s \frac{di_{qs}}{dt} + e_{qs} \\ V_{dr} &= 0 = R_r i_{dr} + \frac{d\Phi_{dr}}{dt} + e_{dr} \\ V_{qr} &= 0 = R_r i_{qr} + \frac{d\Phi_{qr}}{dt} + e_{qr} \end{aligned} \quad [8]$$

The terms  $e_d$  and  $e_q$  resulting from the electromechanical and electromagnetic coupling are given by :

$$\begin{aligned} e_{ds} &= -\frac{M R_r}{L_r} \Phi_{dr} - \sigma L_s \omega_s i_{qs} - \frac{M p}{L_r} \Omega \Phi_{qr} \\ e_{qs} &= p \Omega \frac{M}{L_r} \Omega_{dr} + \sigma L_s \omega_s i_{ds} \frac{M R_r^2}{L_r^2} \Phi_{qr} \\ e_{qr} &= (\omega_{ss} - p \cdot \Omega_{qr} + \frac{M}{L_r} R_r i_{ds}) \\ e_{qr} &= (\omega_{ss} - p \cdot \Omega) \Phi_{qr} - \frac{M}{L_r} R_r i_{qs} \end{aligned} \quad [9]$$

Thus the model of the induction is illustrated by the CIG of the Fig. 6.

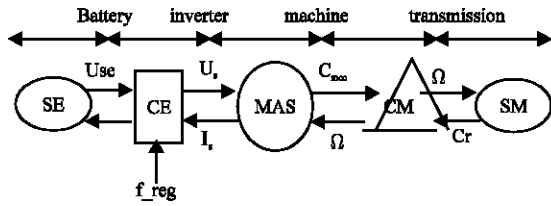

Fig. 6: EMR of an electro mechanic conversion chain

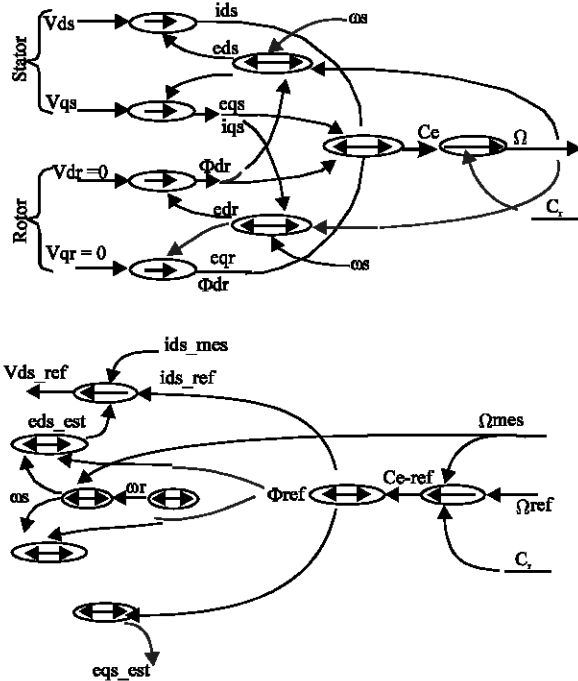

Fig. 7: CIG representation of induction machine

**Strategy of control:** For the control of the induction machine it is necessary to uncouple the flux drive and the current drive producing the couple<sup>[6]</sup>. For that one calls upon an order known as vector its consists in directing flux towards the axis D of the reference

$$\Phi_{dr} = \Phi_r \text{ et } \Phi_{qr} = 0$$

In this case :

$$M.i_{ds} = \Phi_{dr} + \frac{L_r}{R_r} \frac{d\Phi_{dr}}{dt} \quad [10]$$

and the couple become :

$$C_{em} = p \cdot \frac{M}{L_r} \cdot \Phi_{dr} \cdot i_{qs} \quad [11]$$

from these equations, two sizes are to be controlled flux and its position. The flux is controlled by the current  $i_{ds}$

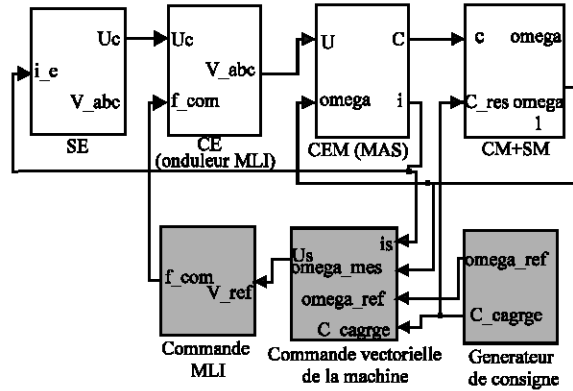

Fig. 8: The control structure of induction machine

thus  $V_{ds}$ , the couple is controlled by the current  $i_{qs}$  thus  $V_{qs}$ .

For an indirect drive we put

$$\Phi_{dr} = \Phi_{ref} = cste$$

with the rules inversion of the CIG we leads to the control GIC shown Fig. 7 with speed and current controllers.

The choice of the controllers we an introduce classic (PI) or intelligent controllers.

The Fig. 8 illustrates the EMR of the chain of conversion with the control shaft produced with MATLAB SIMULINK.

### CONCLUSION

In this work we have one presented a method of structuring the Control of an electromechanical conversion chain we have considered electro mechanic conversion chain with an induction machine in order to highlight the interest of formalism GIC and its importance for the structuring of the laws of order of electric machines and the complex systems. This formalism (GIC) which contributes to the comprehension and the functional description of the induction machine makes it possible to produce the strategy of ordering of the machine starting from a simple and logic reasoning which lies in the inversion step by step of causalities.

Such a tool proves a great utility in the complex systems: complex conversion chains (systems multi actuators, multi converters).

### REFERENCES

1. Bouscayrol, A., X. Guillaud, J.P. Hautier and P. Delarue, 2000. Macro modélisation des conversions électromécanique: Application à la commande des machines électriques . revue internationale de génie électri.

2. Bouscayrol, A., X. Guillaud, P. Delarue and J.P. Hautier, 1999. Structure de commande d'un processus mono machine. Séminaire SMM GDR SDSE Toulouse, pp: 18-19.
3. Bouscayrol, A. and T. Communal, Approche globale de la commande dynamique de machine.
4. Hautier, J.P. and J.P. Caron, 1999. Convertisseurs statiques méthodologie causale de modélisation et de commande Ed technip Paris.
5. Hautier, J.P. , J. Faucher and J.P. Caron, Le graphe informationnel causal: Un outil pour analyser, comprendre, représenter.
6. Hautier, J.P. and J.P. Caron, modélisation et commande de la machine asynchrone Ed technip.