

Integration of Fuzzy Logic Based Control Procedures in Cryogenic Distillation

Riverol, C. and C. Carosi

Chemical Engineering Department, Faculty of Engineering,
University of West Indies, St. Augustine, Trinidad, West Indies

Abstract: The automation of complex industrial processes is a difficult problem due to the extremely nonlinear and variable system behavior or conflicting goals within the different process phases. This article describes an approach in which underlying PID controllers were implemented via fuzzy logic. Traditionally, simple PID and feedforward control schemes do not function well in load-following applications over cryogenic distillation columns. However for high level control, simple controllers can be combined in a priority hierarchy such as this study illustrates using one distillation column.

Key words: Fuzzy logic, control procedures, integration, cryogenic distillation

INTRODUCTION

Industry and in-house experience previously suggested that multivariable technology is well suited for the air separation process. However, the cost and time required to implement such controllers on a mass scale would exceed the available capital, manpower and time. Typically, implementing software packages using conventional engineering methodology takes four to six months and can cost hundreds of thousands of dollars in external control system consultant fees.

The most prevalent regulatory controllers in industrial applications are single-loop PID controllers, which monitor one process variable and apply corrective action as needed. This technology is well proven for single variables or multiple independently manipulated variables. This study describes the application of simpler fuzzy-PID controllers based in a simplified Takagi-Sugeno (TS) rule scheme over a cryogenic column for oxygen production. The old system (PLC) and Fuzzy-PID structures have been compared and tested in the distillation column. The Fuzzy-PID controller has been obtained by the basic shape of membership functions (triangular). It could be expected that fine tuning of membership functions will result in better performance. In this fuzzy controller the proportional, integral and derivative gains constantly vary with the output of the system under control.

Conventional air separation process: Cryogenic distillation is similar to ordinary distillation; however the process takes place at low temperature. In an air

distillation column, nitrogen is the most volatile component and will be therefore be present in high concentration in the top of the column. The distillation columns can contain 60-65 trays approximately. The pressurized dry air is cooled in an efficiency main heat exchanger and directed into the bottom of the High-Pressure (HP) cryogenic distillation column, Fig. 1. The variables depicted over the Fig. corresponding to the following (Inputs with I and outputs with O): air feed: (I1), Gaseous Oxygen: (O1), gaseous nitrogen: (O2), diluted gaseous nitrogen: (I2), liquid nitrogen: (I3), liquid oxygen: (O3), crude oxygen: (I4), low pressure: (LP) and high pressure: (HP). The bottom of the HP column contains oxygen-rich liquid (often called rich liquid) that becomes the feed for the Low-Pressure (LP) cryogenic distillation column. At the top of the HP column is condensed, pure nitrogen and the liquid becomes reflux for the HP column, reflux for the LP column and either liquid or gaseous nitrogen. The bottom of the LP column contains pure liquid oxygen. On most gaseous oxygen-producing plants, the gas oxygen is drawn off directly above the liquid oxygen level in the bottom of the LP column. The top of the LP column contains pure gaseous nitrogen, referred to as low-pressure nitrogen.

The crude argon column is a third cryogenic distillation column that hangs off the side of the LP column. The LP column provides an argon-rich stream to the bottom of the crude argon column. The crude argon column washes the oxygen out of the argon and produces a stream of crude argon that is sent to the pure argon column that strips away the remaining nitrogen to produce marketable liquid argon.

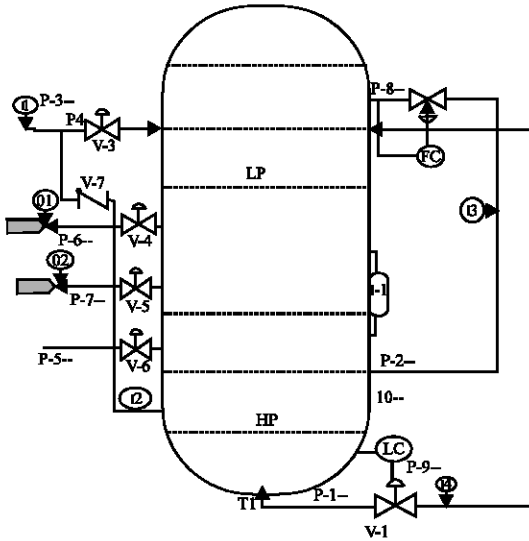

Fig. 1: Distillation column

The model for distillation columns generally consist of differential equations for the mass and energy balances around each tray and a set of algebraic equations consisting of equations for tray pressure drop, liquid flow from the tray, liquid aeration, phase equilibrium, physical properties and a number of boundary conditions. A detailed mathematical model of a tray would become extremely complex whether no assumptions or a priori simplifications would be made. In this study they are the following:

- The liquid and vapor are ideally mixed, hence there are no concentration gradients on a tray;
- The liquid and vapor which are in contact are in thermal equilibrium;
- The pressure and temperature on a tray are uniform
- Weeping and entrainment can be ignored;
- The tray efficiency is constant and does not depend on column loading
- The vapor flow to the condenser will be totally condensed and all liberated heat will be used in the reboiler.
- The reboiler behaves like a normal tray; the additional term is the added energy from the condenser. The same assumptions therefore apply as were made for a tray, such as vapor-liquid equilibrium and so forth.

The top vapor flow of the high-pressure column condenses in the condenser and generates the vapor low for the low pressure column. The energy content (E) is defined by:

$$\frac{dE}{dt} = F_{Li} h_{Li} - F_{vo} h_{vo} - F_{Loxygen} h_{Loxygen} - F_{Goxygen} h_{Goxygen} + Q$$

Where h is enthalpy and F is flow. The energy balance for a tray is equivalent to a pressure balance, under the assumption that concentration changes are slow compared to pressure changes, which is shown^[1] and^[2]. The mass and energy balance can be combined and written as:

$$(C_{pT} + C_{pp}) \frac{dp}{dt} = F_{vi} - F_{vo}$$

For additional equations, the reader can see^[3-5]. The oxygen concentration is measured and controlled at three points as shown in the Fig. 1: low of HPC, side stream of LCP and feed of HPC. The pressure and temperature are controlled as well. The manipulated variables are: feed flow, reflux of diluted liquid nitrogen at HPC, liquid oxygen and nitrogen at middle of column. The column operated to low pressure at 2.6 bar (average) and 6.0 bar to high pressure (average). Perfect level is assumed throughout this study. The range of the different manipulated variables was the following:

Air flow: $0 \leq u_1 \leq 120$ Kmol/min

Nitrogen flow to HP column: $0 \leq u_2 \leq 1.20$ Kmol/min (1)

Nitrogen flow from HP column: $0 \leq u_3 \leq 11.0$ Kmol/min

Liquid oxygen flow: $0 \leq u_4 \leq 4.67$ Kmol/min

Design of underlying PID controller via fuzzy logic: The primary control objectives were:

- Product qualities: Maintain nitrogen and oxygen products on specification and minimize the waste nitrogen purity and crude argon impurities.
- Maximize product yield: Maximize oxygen, nitrogen and argon product recovery from the incoming air feed.
- Stabilize the process: Adjust process conditions to maintain the unit operation within process and equipment constraint limits and minimize transient disturbances when the unit is being ramped to new feed or product targets.

The project team consisted of one control engineer, two graduate students, one external researcher and the operators. Some initial plant testing had been done, but a conventional application would still require substantial offline modeling and PC-DCS interface work; the strategy was the following:

- Use the information from human operator who observes the behavior of the existing control system and knows how this controller should be tuned under various operation conditions.

- Simplify the mathematical models to first-order approximations, as the plant operations are primarily single-phase separations using step responses of the nonlinear model for perfect level and pressure control is used.

Over 90% of the controllers in operation today in the plant are PID. This is because PID controllers are easy to understand, easy to explain to others and easy to implement. The basic form for the PID controller is:

$$u(t) = K_p e(t) + K_i \int_0^t e(\tau) d\tau + K_d \frac{de(t)}{dt} \quad (2)$$

Where K_p is the proportional gain, K_i is the integral gain and K_d is the derivative gain. Because the PID controllers are often not properly tuned, there is a significant need to develop methods for the automatic tuning of PID controllers. In this study, the old system were substituted for fuzzy PID controllers, in which the experience and intuition of skilled operator are incorporated; the major advantage of this technology over the traditional control technology is its capability of capturing and utilizing qualitative human experience and knowledge in a quantitative manner, however its design is not easy and the implementation requires long time. In the literature, there exist two different types of fuzzy controllers: The Mandani type and Takagi-Sugeno type. They mainly differ in the fuzzy rule consequent: a Mandani fuzzy controller utilizes fuzzy set as consequent while Takagi-Sugeno employs linear functions of inputs variables.

In this study, we configured Takagi-Sugeno PID Controllers (TSPID). The TSPID uses to be the same performance that the classical PID, see equation (2). The variables are:

$$\begin{aligned} \alpha_1(n) &= SP(n) - Y(n) \\ \alpha_2 &= \alpha_1(n) - \alpha_1(n-1) \\ \alpha_3 &= \alpha_2(n) - \alpha_2(n-1) \end{aligned} \quad (3)$$

Where SP is the setpoint signal of system output and $y(n)$ is the system output at sampling time n . Variables α_1 , α_2 and α_3 represent the position, velocity and acceleration of the system output. Each variable is fuzzified by two Input fuzzy sets, positive and negative and their mathematical definitions are identical for input variables:

$$\mu_p(\alpha_i) = \begin{cases} 0 & \alpha_i < op \\ \frac{\alpha_i}{op} + 0.1 & -op \leq \alpha_i \leq op \\ 1 & \alpha_i > op \end{cases} \quad (4)$$

$$\mu_n(\alpha_i) = \begin{cases} 0 & \alpha_i < op \\ -\frac{\alpha_i}{op} + 0.1 & -op \leq \alpha_i \leq op \\ 1 & \alpha_i > op \end{cases}$$

Where op is the optimal value that depend on the parameter to controlled. For example for concentration of oxygen in the low of HPC, op is 94%, in the feed, op is 38% and side stream of LCP the op is 90%. For the pressure in the LPC, the op is 2.5 bar and HPC is 6.0 bar and finally the op for the temperature is 100K.

A total eight different combinations of input fuzzy sets exist by each PID (5 PIDs must be tuning, three for concentration, one for temperature and one for pressure). We need eight fuzzy rules to cover them. TS rules have following the scheme:

e.g. IF $\alpha_1(n)$ is A AND $\alpha_2(n)$ is B and $\alpha_3(n)$ is C THEN $v(n) = a_1 \alpha_1(n) + a_2 \alpha_2(n) + a_3 \alpha_3(n)$

where v denotes the contribution of j th rule to the controller output. And a_i is constant parameters. Eight difference fuzzy sets for each PID gave a total of 40 rules. We use the product fuzzy logic AND operator to combine the three membership $\mu_j = \mu_p(\alpha_1) \mu_p(\alpha_2) \mu_p(\alpha_3)$ or $\mu_j = \mu_p(\alpha_1) \mu_n(\alpha_2) \mu_n(\alpha_3)$ values in each of rule antecedents to generate a combined membership, where p or n denote positive or negative. Finally, the centroid defuzzifier method for defuzzification was used

$$\Delta u(n) = \frac{\sum_j \mu_j v_j(n)}{\sum_j \mu_j} \quad (5)$$

Where the a_i parameters are calculated using the gradient method that consist in choosing the a_i to minimize the quadratic function e_m that quantifies the error between the current data pair (x,y) . The equation is the following:

$$a_i(k+1) = a_i(k) - \lambda \frac{\partial e_m}{\partial a_i} \quad (6)$$

Where k is the index of parameter update step and $e_m = 0.5 |\Delta u - y|^2$. The parameter λ characterizes the step size, it must be positive because another case creates instability in the system^[6]. If the step size is chosen too small, then a_i is adjusted very slowly. However, if the step

size is big, the convergence may come faster but it can step over the minimum value of e_m

Taking the idea from^[7] and ensures that the control is less susceptible to parameter fluctuations; the temperature T and P were conveniently rescaled with respect to their set points. The temperature is

$$\phi = \frac{(T - T_{\infty})}{(T_s - T_{\infty})}$$

and pressure

$$\phi = \frac{P}{P_{max}}$$

where $0 \leq \phi, \phi \leq 1$. The time is also rescaled using a timescale t_s (10 minutes) with,

$$\tau = \frac{t}{t_s}$$

using the same fuzzy input variables defined before. Only, is very important to take account that the output has been truncated using the dimensionless variables, the new range is^[11]. The conventional PID controller is recovered (fuzzy logic equivalent).

While the distillation column is working, is easy to verify that the liquid nitrogen flow from side of HP column and liquid nitrogen flow to top of LP column (reflux) affect % nitrogen in gaseous oxygen flow from LP column more than total air flow does, a similar situation exists for % oxygen in dilute nitrogen flow from LP column vs air flow to LP column. Hence, the single loop control concept is not very attractive for this reason and multivariable control is a good alternative. The behavior recognizer seeks to characterize the current behavior of the plant (with the model) in a way that will be useful to the PID designer.

In the process, the flow of oxygen should have a minimum purity (94%). The manipulated variables all have lower and upper limits dictated by the size of the valve, the lower limit for the flow to the low pressure column, as minimum 55% of the flow at normal conditions should be maintained.

The Fig. 2 depicted the control system used. The Fuzzy scheduler uses the equations from (2) to (6) for define the fuzzy-PID controller in any case. Using a PC and Visual Basic, the fuzzy system was programmed and method of the lines was utilized in the calculation of the partial first derivative of the equation (6). The first task was to determine the optimum step size (λ), the trial and error method was used. Considering perfect level and a

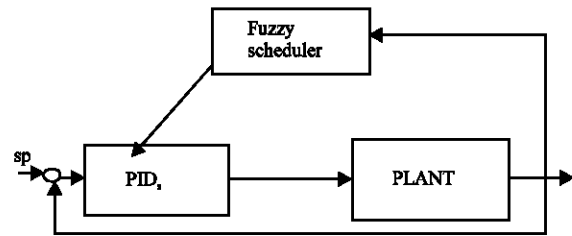

Fig. 2: Fuzzy PIDs system

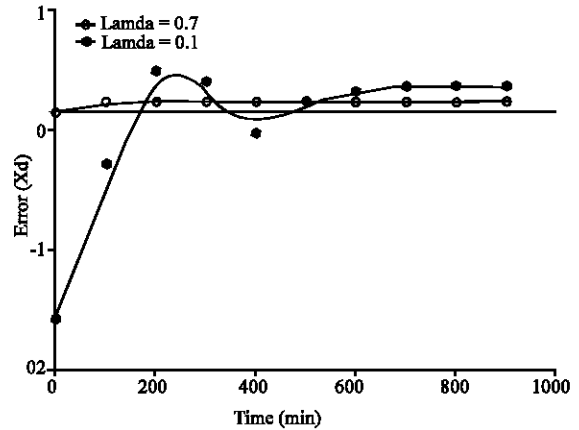

Fig. 3: Response of the system to an 18% step in the feed flow air

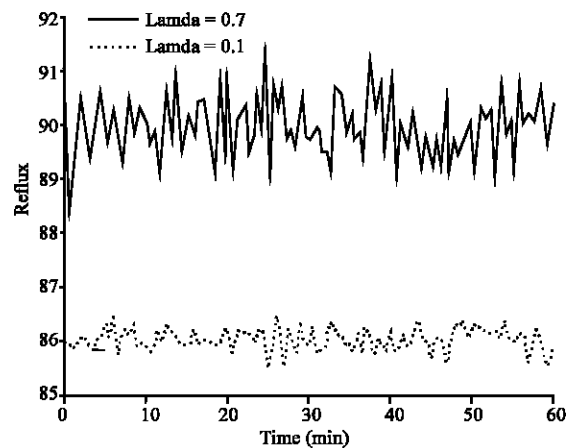

Fig. 4: Response of the reflux flow at different step size in the gradient method

20% step in the feed flow, the column was simulated to different values of λ and the settling time was calculated. A resume of result is shown in the Table 1. To get the optimum value of λ adds complexity in the problem, as example, the Figs. 3 and 4 depicted as the value of λ affects the composition of distillation and the reflux flow; is clear to see as the distillation composition shows offset when the value is 0.7 and the reflux flow gets another steady state point. Using the Table 1, finally the optimum

Table 1: Evaluation of the step size

λ	Settling time (min)	IAE
0.01	25.1	9.1234
0.05	18.3	10.5541
0.1	13.4	12.4478
0.2	9.3	15.3398
0.3	8.4	15.7701
0.4	4.7	16.0267
0.5	3.6	16.2233
0.6	3.8	15.3478
0.7	4.5	21.6612
0.8	5.1	23.2355
0.9	5.7	43.8800
1.0	5.9	44.5669
1.2	6.4	48.1203
1.4	7.8	50.3491

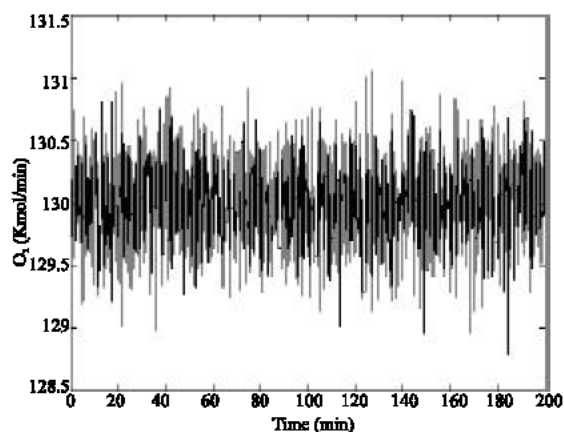

Fig. 5: Flow of oxygen using fuzzy PID

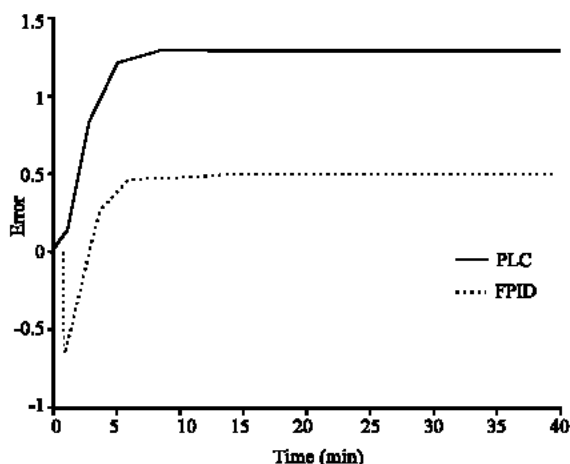

Fig. 6: % relative error in the distillation composition

was fixed in $\lambda = 0.6$ where the smallest settling time was obtained.

Afterward, the underlying fuzzy-PID was tested in parallel with the PLC used in the column. An example of the results is illustrated in the Figures 5 and 6 and the Table 2. The Fig. 5 shows as the product flow is keeping in 130 mol/min and a reduction in the % relative error in the distillation composition is obtained. With the new system the error is 0.6% (average) and with the old system

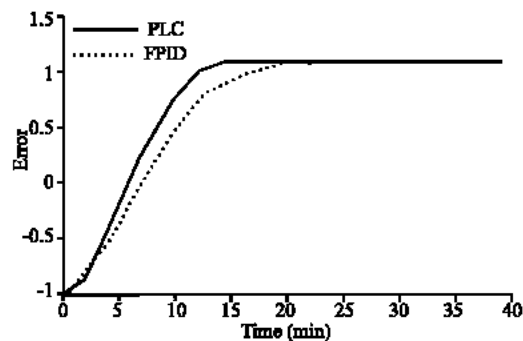

Fig. 7: Response of the change in oxygen (ppm) in pure nitrogen flow from HP column

Table 2: Evaluation of the performance on line

Variable	PLC (operation conditions)		
	% Error	IAE	%manipulation of valve
Temperature	1.9	22.4670	N/A
Pressure	2.8	36.7100	N/A
Airflow	N/A	N/A	14.1
Reflux	N/A	N/A	12.0
Underlying Fuzzy PID (operation conditions)			
Temperature	1.1	15.3360	N/A
Pressure	1.4	18.9003	N/A
Airflow	N/A	N/A	11.0
Reflux	N/A	N/A	9.0
PLC (reduction between 1/3 and 1/5 of air flow)			
Temperature	2.2	43.5622	N/A
Pressure	4.5	54.0023	N/A
Airflow	N/A	N/A	35.0
Reflux	N/A	N/A	18.0
Underlying Fuzzy PID (reduction between 1/3 and 1/5 of air flow)			
Temperature	1.3	21.4112	N/A
Pressure	5.8	26.5509	N/A
Airflow	N/A	N/A	16.1
Reflux	N/A	N/A	12.2
PLC (increasing between 1/3 and 1/2.5 of air flow)			
Temperature	2.8	41.9970	N/A
Pressure	1.7	66.9360	N/A
Airflow	N/A	N/A	34.7
Reflux	N/A	N/A	21.0
Underlying Fuzzy PID (increasing between 1/3 and 1/2.5 of air flow)			
Temperature	1.6	20.5509	N/A
Pressure	2.7	29.0033	N/A
Airflow	N/A	N/A	18.8
Reflux	N/A	N/A	16.2

is 1.1% (average), this reduction means an increasing in the quality of the product and also in the nitrogen flow as illustrates the Fig. 7 where the concentration of oxygen is kept in minimum level to different conditions (high and low air flow). The Table 2 depicts as the new system offers the advantage of smoothness of operation and contributes much in the way of energy and labor saving (reduction of the manipulation of the valve). The attenuation of the manipulated variables increases the performance of the system and keeps the temperature and

pressure constants without great problems. The Table 2 illustrates the behavior of the system in different conditions, the classical system shows oscillations and the response is slow when the feed flow, pressure and temperature are modified especially the start up, however the new set of controllers kept the smoothness of operation ever.

As future perspective, the maintenance of the installed controller and update the fuzzy rules, especially in light of the mismatch between the linear system and the nonlinear process whose operating conditions often change, is a new challenge. Historically, a lack of controller maintenance has been a principal factor in the disappointing performance of some installations. Processes in the real world do not remain constant over time and as changes in the plant and/or its instrumentation are made, corresponding changes to the advanced controller are necessary to ensure optimal performance and gains in efficiency.

CONCLUSION

The implementation methodology outlined here describes a new approach using generic dynamic models or reusing models for fine-tuning PID online and thus to get the desired controller performance. Controllers can be implemented very quickly and can learn using the fuzzy interface and PID designer. Moreover, the controller can be improved using the experience of operators and updated any moment when is necessary.

ACKNOWLEDGEMENT

The authors would like to thank to DHC Engineering for support the project.

REFERENCES

1. Bisowarno, B.H. and M.O. Tade, 2000. The comparison of disturbance rejection properties of one-point control schemes for etbe reactive distillation, *Chemical Engineering Communications*, pp: 85-100.
2. Meeuse, F.M. and R.L. Tousain, 2002. Closed-loop controllability analysis of process designs: Application to distillation column design *Computers and Chemical Engineering*, pp: 641-647.
3. Mandler, J.A., 2000. Modeling for control analysis and design in complex industrial separation and liquefaction processe *J. Process Control*, pp: 167-175.
4. Hoch, P.M., A.M. Eliceche and I.E. Grossmann, 1995. "Evaluation of design flexibility in distillation columns using rigorous models *Computers and Chemical Engineering*, pp: 669-674.
5. Skogestad, S. and M. Morari, 1987. A systematic approach to distillation column control, *ICHEM Symposium Series*, 104, A-71-A86 .
6. Passino, K. and S. Yurkovich, 1998. *Fuzzy control*, Addison Wesley.
7. Blanchett, T., G. Kember and R. Dubay, 2000. PID gain Scheduling using Fuzzy logic, *ISA Transactions*, 39: 317-325.