

Efficient Cancellation of Artifacts in EEG Signal using ANFIS

¹C. Kezi Selva Vijila, ²P. Kanagasabapathy,
¹Stanley Johnson and ¹Vinodh Edwards
¹University of Karunya, Coimbatore, India
²M.I.T, University of Anna, Chennai, India

Abstract: The artifacts present in the Electroencephalogram (EEG) signal cannot be filtered directly because they turn into an immeasurable interference signal when they pass through the human body and also the spectrum of the EEG signal and the interference signal overlap each other. In this study, we propose a hybrid soft computing technique called Adaptive Neuro-Fuzzy Inference System (ANFIS) to estimate the interference and to separate the EEG signal from its Electrooculogram (EOG), Electrocardiogram (ECG) and Electromyogram (EMG) artifacts. This study shows that the proposed method successfully removes the artifacts and extracts the desired EEG signal.

Key words: Neuro fuzzy, adaptive noise cancellation, EEG extraction, artifacts

INTRODUCTION

The EEG is a noninvasive method of demonstrating cerebral function. EEG measurements are required to monitor alertness, coma, brain death, to locate areas of damage following head injury, stroke, tumor, to test afferent pathways, for controlling anesthesia depth and to investigate epilepsy and locate seizure origin. Normal EEG signals are measured from electrodes placed on the scalp. The amplitude of EEG signal, which is very small, is measured in microvolts. The EEG is often affected by a variety of large signal contaminations or artifacts, which reduce its clinical usefulness and present serious problems for electroencephalographic interpretation and analysis (Potter *et al.*, 2002). Artifacts in EEG are commonly handled by discarding the affected segments of EEG. The simplest approach is to discard a fixed length segment, perhaps one second, from the time an artifact is detected. The recognition of the eye blink and eye movement artifacts is generally effected by detecting a voltage increase in the EOG channel above a threshold, generally 100 microvolt. Other artifacts are generally ignored or manually marked by a practitioner and discarded. Discarding segments of EEG data with artifacts can greatly decrease the amount of data available for analysis. EEG data collected from children are especially problematic in this respect (Koles, 1991).

The first attempt at removing artifacts was focused on eye blinks. Regression using the EOG channel was attempted in the time and frequency domain (Koles, 1991; Gratton, 1983; Schl *et al.*, 1999; Vigon *et al.*, 2000;

Whitton *et al.*, 1978). These methods rely on a clean measure of the artifact signal to be subtracted out. Since the EOG is contaminated with EEG signals, the regression of ocular artifacts has the undesired effect of removing EEG signals from the observations. More recently, multivariate statistical analysis techniques, such as principal component analysis, have been used to separate and remove artifact signals from the brain activity of interest (Potter *et al.*, 2002; Jung *et al.*, 2000a, b; Overton and Shagass, 1969; Verleger *et al.*, 1982; Verobyov and Chichocki, 2002).

Comparisons of artifact removal using different transformations can be found in (Verobyov and Chichocki, 2002; Jung *et al.*, 1998). Vigon *et al.* (2000) compared four methods for artifact removal by artificially mixing an artifact signal from one subject with a set of EEG signals from another subject. The artificial mixing matrices were chosen to approximate mixing in the scalp. The authors found that the two independent component analysis methods studied, Infomax and Jade (Chichocki and Verobyov, 2000) were significantly better than principal component analysis and simple EOG subtraction. It is not known how well artificially mixing a signal from one subject with those of another subject approximates the actual circumstances of artifact contamination of EEG. The common spatial patterns technique was used by Koles and Kenemans *et al.* (1991) to remove abnormal components from an EEG recording. No quantitative evaluation was done on the removal but it was visually observed that the artifacts were extracted into a small number of components that would allow their removal.

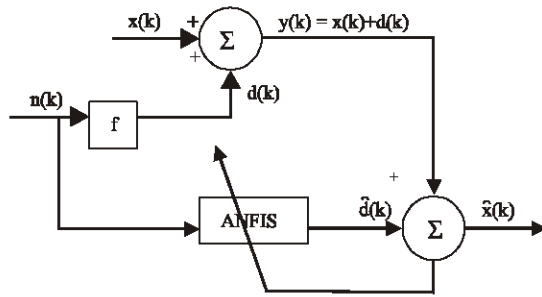

Fig. 1: Schematic diagram of ANC

Kalman filters and extended Kalman filters have also been used for artifact detection with success depending heavily on the artifact type (Schl *et al.*, 1999; Jung *et al.*, 2000). In this study we focus on artifacts removal in EEG signal using the recent soft computing techniques called hybrid neuro fuzzy logic. This study is organized as follows.

ADAPTIVE NOISE CANCELLATION

The principle used for the elimination of artifacts is ANC. It is a process by which the interference signal can be filtered out by identifying a linear model between a measurable noise source (artifact) and the corresponding immeasurable interference (Jang *et al.*, 1997). Figure 1 shows noise cancellation with ANFIS filtering. Here we have a required signal $x(k)$ (EEG) and a noise source signal $n(k)$ (artifacts). The noise signal goes through unknown nonlinear dynamics f (human body) and generate a distorted noise $d(k)$, which is then added to $x(k)$ to form the measurable output signal $y(k)$. The aim is to retrieve $x(k)$ from the measured signal $y(k)$ which consists of the required signal $x(k)$ plus $d(k)$, a distorted and delayed version of $n(k)$ i.e. the interference signal. In symbols, the measured signal is expressed as

$$y(k) = x(k) + d(k) = x(k) + f(n(k), n(k-1), n(k-2), \dots) \quad (1)$$

The function $f(\cdot)$ represents the passage dynamics that the noise signal $n(k)$ goes through. If $f(\cdot)$ was known exactly, it would be easy to recover $x(k)$ by subtracting $d(k)$ from $y(k)$ directly. However, $f(\cdot)$ is usually unknown in advance and could be time varying due to changes in the environment. Moreover the spectrum of $d(k)$ may overlap with that of $x(k)$ substantially, invalidating the use of common frequency domain filtering techniques. To estimate the interference signal $d(k)$, we need to pick up a clean version of the noise signal $n(k)$ that is independent of the required signal. However, we cannot access $d(k)$ directly since it is an additive component of the overall measurable signal $y(k)$ (Jang *et al.*, 1997).

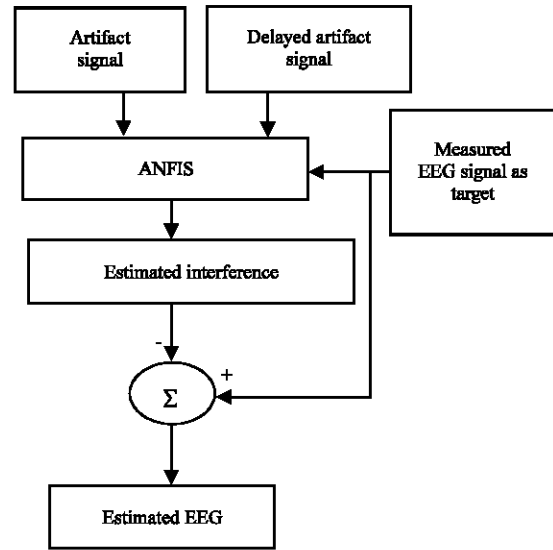

Fig. 2: Flowchart for the cancellation of artifacts and the extraction of EEG

In Fig. 1 ANFIS is used to estimate the unknown interference $\hat{d}(k)$. When $\hat{d}(k)$ and $d(k)$ are close to each other, these two get cancelled and we get the estimated output signal $\hat{x}(k)$ which is close to the required signal.

Steps for performing ANC in this application are shown in Fig. 2. ANFIS takes the artifact as the reference signal and tries to estimate the interference present in the measured EEG signal. Once the designated epoch is reached or the goal is reached, it will stop training and will give the estimated interference signal. Then EEG is extracted by simply subtracting the estimated interference from the measured EEG signal.

Types of artifacts: Contamination of EEG signal can occur at many points during the recording process. Improving technology can decrease externally generated artifacts, such as line noise, but biological artifact signals must be removed after the recording process. Blinking or moving the eyes produces large electrical potential around the eyes called EOG. The EOG spreads across the scalp to contaminate the EEG and this is called an Ocular artifact. Ocular artifacts make it difficult in distinguishing normal brain activities from abnormal ones. The eye blink artifact is very common in EEG signal. It produces a high amplitude signal that can be many times greater than the EEG signals of interest. Because of its high amplitude an eye blink can corrupt signal on all electrodes, even those at the back of the head. Eye artifacts are often measured more directly in the EOG, using a pairs of electrodes placed above and around the eyes. Unfortunately, these measurements are contaminated with EEG signals of

interest and so simple subtraction is not a removal option even if an exact model of EOG across the scalp is available (Jung *et al.*, 1998). Eye movement artifacts are caused by the reorientation of the retinocorneal dipole (Jung *et al.*, 1998; Blume *et al.*, 2002; Shao *et al.*, 2004). Eye blinks and movements often occur at close intervals.

ANFIS: ANC using linear filters has been used successfully in real world applications such as interference canceling in Electrocardiograms, echo elimination on long distance telephone transmission lines and antenna side lobe interference canceling. This concept of linear adaptive noise cancellation can be extended to non-linear realms by using nonlinear adaptive systems. Thus ANFIS is one such nonlinear adaptive system, which is proposed in this study to estimate an unknown interference present in the desired EEG signal. Over the last few decades, neural networks and fuzzy systems have established their reputation as alternative approaches to signal processing. Both have certain advantages over conventional methods, especially when vague data or prior knowledge is involved. However, their applicability suffered from several weaknesses of the individual models. Therefore, combinations of neural networks with fuzzy systems have been proposed, where both models complement each other. This neuro-fuzzy system overcome some of the individual weaknesses and offer some appealing features. Neural networks recognize patterns and adapt themselves to cope with changing environments. Fuzzy inference systems incorporate human knowledge and perform inferencing and decision making. Neuro Fuzzy takes the advantages of the combination of neural network and fuzzy logic. The basic idea of combining fuzzy systems and neural networks

is to design an architecture that uses a fuzzy system to represent knowledge in an interpretable manner, in addition to possessing the learning ability of a neural network to optimize its parameters (Shing and Jang, 1993). The drawbacks of both of the individual approaches-the black box behavior of neural networks and the problems of finding suitable membership values for fuzzy systems-could thus be avoided. Steps for the implementation of ANFIS uses Matlab command called `genfis` to generate the Fuzzy Inference System (FIS) model, command `ANFIS` to train the FIS model with parameters like MF, type of MF, epochs, etc and command `evalfis` to determine the output of the FIS system for given input. The general architecture of ANFIS with two inputs and one output is shown in Fig. 3. ANFIS consists of 5 layers excluding inputs and output. Layer 1 performs fuzzification, layer 2 node output represents the firing strength of a rule. Layer 3 is used for normalization. Layer 4 is used to find the consequent parameters and layer 5 is to find the overall output. Assume that FIS has two inputs x, y and one output z .

Rule1: If x is A_1 and y is B_1 , then

$$f_1 = p_1x + q_1y + r_1.$$

Rule2: If x is A_2 and y is B_2 , then

$$f_2 = p_2x + q_2y + r_2.$$

In Fig. 3(a), p, q and r represent the consequent parameters. A and B are linguistic labels.

In this study we have taken signals namely artifact and delayed artifact as inputs and measured EEG signal as target for training the ANFIS structure. we have used generalized bell type as the Membership Function (MF) for tuning the FIS parameters.

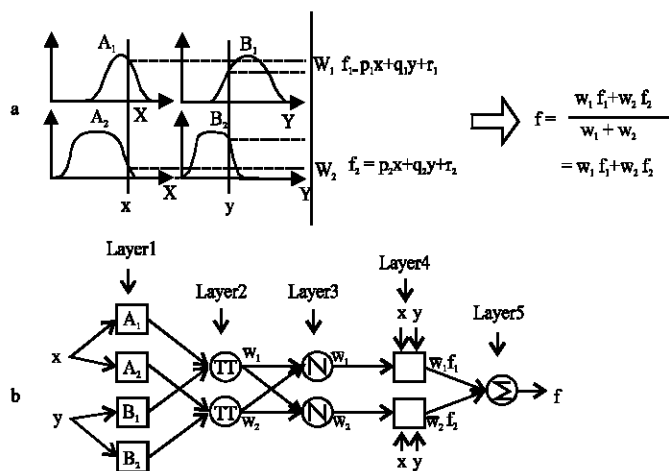

Fig. 3: (a) A two-input first-order fuzzy model with two

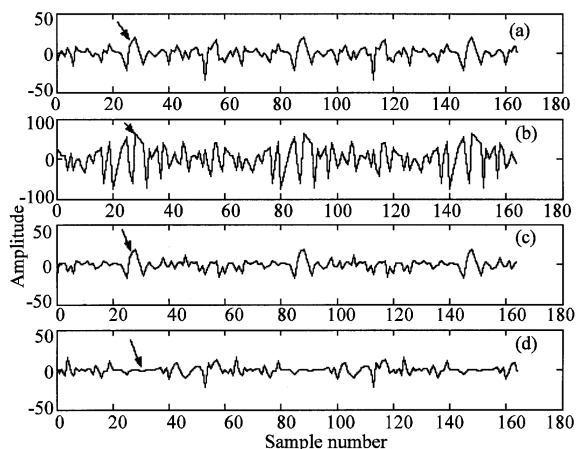

Fig. 4: (a) EEG signal (b) EOG- Right artifact (c) Estimated EOG -Right present in the EEG signal (d) Estimated EEG signal after removing the artifact

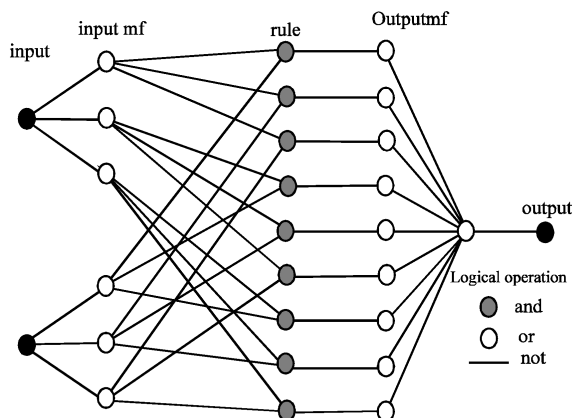

Fig.5: ANFIS Structure

Hybrid learning rule: Though we can apply the gradient method alone to identify the parameters in an adaptive network, the method is generally slow and likely to become trapped in local minima. Hence hybrid learning algorithm is used in ANFIS to train the network parameters. It combines the gradient method and the least square estimate to identify the parameters. This rule decreases the dimension of the search space in the gradient method and also cuts down substantially the convergence time. Since the ANFIS architecture is a multilayer network, back-propagation learning rule is used to tune the parameters in the hidden layer and the parameters in the output layer can be identified by the least squares method. The hybrid learning rule detail is given in (Shin and Jang, 1993). The aim of ANFIS in this study is to estimate the unknown interference present in the measured signal using the hybrid-learning algorithm.

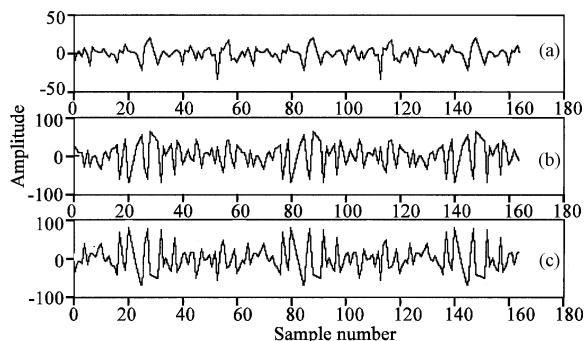

Fig. 6: Direct Subtraction Output (a) EEG signal (b) EOG Right artifact (c) EEG signal after removing the artifact

RESULTS AND DISCUSSION

In this study, the results of EEG signal with several artifacts removal using ANFIS are discussed. These real signals are taken from the database available in the physionet website ([www. Physionet. Org.](http://www.Physionet.Org)). For demonstrating the proposed method, we have taken real EEG signal with artifacts from one subject and have performed the ANC using ANFIS. These signals have the the following statistics:

- EEG signal sampled at 125 Hz.
- Right and left electrooculograms (EOG-Right, EOG-Left), sampled at 50 Hz. These are the real artifacts in EEG signal.
- A bipolar submental EMG, sampled at 125 Hz. This is assumed to be another artifact in EEG signal.

Case 1: Consider the real EEG signal and EOG-Right artifact. ANC using ANFIS is performed and the adaptation process continues till the estimated EEG signal is free from the artifacts. In Fig. 4a represent the EEG signal and the arrow indicates the presence of artifacts, (b) is the measurable artifact which acts as the reference signal (c) is the estimated interference through ANFIS and (d) shows the estimated EEG signal after removing EOG Right artifact. ANFIS structure for this case is shown in Fig. 5. It has 2 nodes in the input, each representing the input variables. Layer 1 has 3 MF's for each variable. Layer 2 has 9 rules. Normalization layer is not shown in this figure. Nodes in layer 4(outputmf) are used for finding the consequent parameters. Single node in layer 5 is to find the overall output. It has single output because the fuzzy system used in this application is sugeno model.

The output obtained through direct subtraction method with the same signals is shown in Fig. 6.

Table 1: Performance analysis of ANFIS for EEG signal with EOG-right as artifact

Sl. No	No. of epochs	SNR (dB) Measured signal	SNR (dB) Estimated signal	MSE
1	10	8.3836	22.4476	3.7865
2	20	8.5106	22.5552	3.6987
3	50	9.4671	23.854	2.9519
4	100	10.9420	26.4745	1.9599

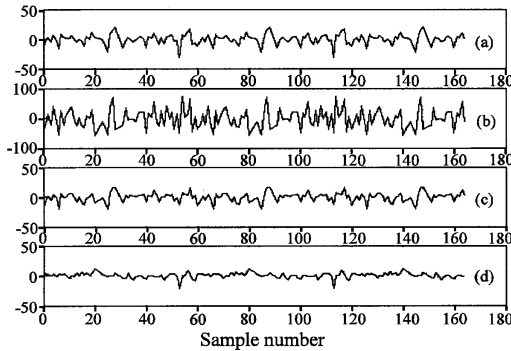

Fig. 7: (a) EEG signal (b) EOG Left artifact (c) Estimated EOG Left present in the EEG signal (d) Estimated EEG signal after removing the artifact

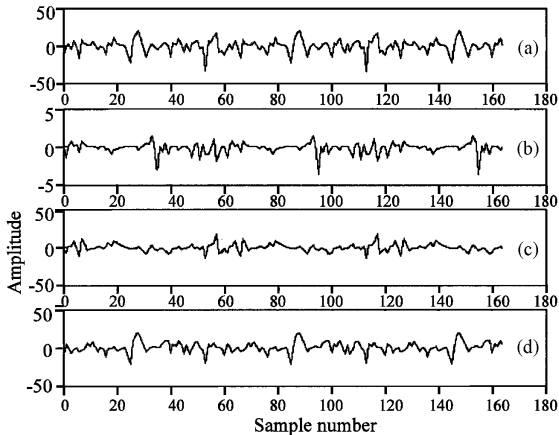

Fig. 8: (a) EEG signal (b) EMG artifact (c) Estimated EMG present in the EEG signal (d) Estimated EEG signal after removing the artifact

Figure 6c shows that the extracted EEG signal still consists of artifacts. The Performance analysis of ANFIS for EEG signal with EOG-Right as artifact is shown in Table 1 for 3 MF's. Signal to Noise Ratio (SNR) of the estimated signal after removing the artifact is high compared to the SNR of the measured EEG signal. The same analysis can be performed for EEG with different artifacts.

Case 2: Consider the real EEG signal and EOG-left artifact. The result obtained is shown in Fig. 7.

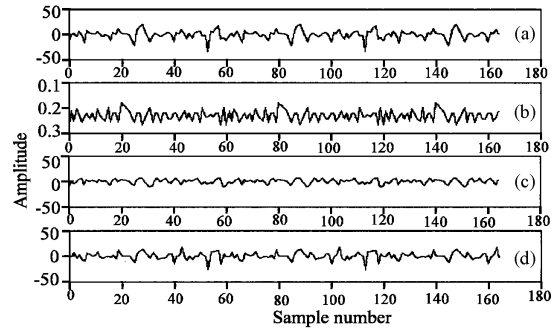

Fig. 9: (a) EEG signal (b) ECG artifact (c) Estimated ECG (d) Estimated EEG signal after removing the artifact

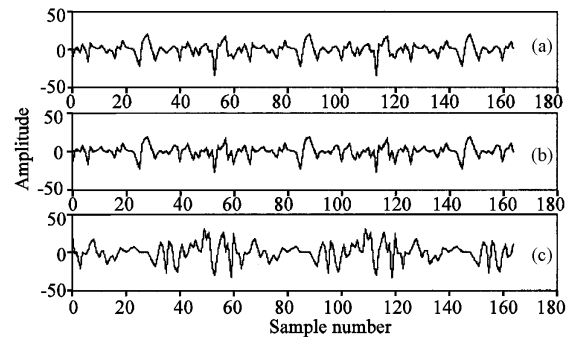

Fig.10: (a) EEG signal (b) Estimated combined artifacts present in the EEG signal (c) Estimated EEG signal after removing the artifact

Case 3: Consider the real EEG signal and EMG as the artifact signal. The result obtained is shown in Fig. 8.

Case 4: Consider the real EEG signal and ECG as the artifact. Result is shown in Fig. 9.

Case 5: Consider the real EEG signal and EOG Left and EOG Right combined artifacts. The amplitude of EMG and ECG are negligible. Result is shown in Fig. 10.

When we compare the results obtained using the proposed technique with neural network and the conventional adaptive filter using least mean square algorithm, we can conclude that neuro fuzzy yields the better results (Kezi *et al.*, 2006).

CONCLUSION

The various artifacts mixed in the EEG signal cannot be filtered directly because they pass through the human body and turn into an interference component. This interference component cannot be estimated directly because the spectrum of the EEG signal and the interference signal overlap each other and also because of

the characteristics of noise and the EEG signal which vary with time. In this study, adaptive noise cancellation using ANFIS is performed on EEG signal with various interferences and their results are plotted. The detailed analysis is shown for case 1 and the performance of ANFIS is compared with varying number of epochs. On the implication phase, the time of execution is found to increase as the epoch value is increased. From the obtained results we conclude that ANFIS successfully removes the artifacts without affecting the EEG signal.

REFERENCES

- Blume, W.T., M. Kaibara and G.B. Young, 2002. Atlas of Adult Electroencephalography.
- Cichocki A. and S. Vorobyov, 2000. Application of ICA for automatic noise and interference Cancellation in multisensory biomedical signals, Proceedings of the Second International Workshop on ICA and BSS, pp: 616-626.
- Gratton, G., M.G. Coles and J. Mocks, 1983. A new method for online removal of ocular artifact. *Electroencephalography and Clinical Neurophysiol.*, 19: 202-480.
- Jung, T.P., S. Makeig, M. Westereld, J. Townsend, E. Courchesne and T.J. Sejnowski, 2000. Removal of eye activity artifacts from visual event-related potentials in normal and clinical subjects, *Clinical Neurophysiol.*, 111: 1721-58.
- Jung, T.P., C. Humphries, T.W. Lee, M.J. McKeown, V. Iragui, S. Makeig and T.J. Sejnowski, 2000. Removing electroencephalographic artifacts by blind source separation, *Psychophysiology*, 37:153-178.
- Jung, T.P., C. Humphries, M. Lee, V. Iragui, S. Makeig and T. Sejnowski, 1998. Removing electroencephalographic artifacts: Comparison between ICA and PCA, *IEEE. Int. Workshop on Neural Networks for Signal Processing*, pp: 63-72.
- Jang, J.S.R., C.T. Sun and E. Mizutani, 1997. *Neuro Fuzzy and Softcomputing*, Prentice Hall International Inc.
- Jyh-Shing, Roger Jang, 1993. ANFIS: Adaptive Network based Fuzzy Inference System, *IEEE Transaction Systems, Man and Cybernetics*, Vol. 23.
- Koles, Z.J., 1991. The quantitative extraction and topographic mapping of the abnormal components in the clinical EEG, *Electroencephalography and Clin. Neurophysiol.*, 79: 440-447.
- Kezi Selva vijila, C., P. Kanagasabapathy and Stanley Johnson, 2006. Fetal ECG Extraction using Softcomputing Technique, *J. Applied Sci.*, 6: 251-256.
- Kenemans, J.L., P. Molenaar, M.N. Verbaten and J.L. Slangen, 1991. Removal of the ocular artifact from the EEG: A comparison of time and frequency domain methods with simulated and real data, *Psychophysiol.*, 28:114-121.
- Min Shao, Kenneth E. Barner, Michael H. Goodman, 2004. An Interference Cancellation Algorithm for Non Invasive Extraction of Transabdominal Fetal Electroencephalogram (TaFEEG), *IEEE. Trans. Biomed. Eng.*, 3: 471-483.
- Overton D.A. and C. Shagass, 1969. Distribution of eye movement and eye blink potentials over the scalp, *Electroencephalography and Clin. Neurophysiol.*, 27: 186.
- Potter, M., N. Gadhok and W. Kinsner, 2002. Separation performance of ICA on simulated EEG and ECG signals contaminated by noise, *Canadian J. Elec. Computer Eng.*, 27: 114-127.
- SchlÄogel, A., P. Anderer, S.J. Roberts, M. Pregenzer and G. Pfurtscheller, 1999. Artefact detection in sleep EEG by the use of Kalman Filtering, *Proceedings of EMBC'*, 99: 648-649.
- Vigon, L., M.R. Saatchi, J.E.W. Mayhew and R. Fernandes, 2000. Quantitative evaluation of techniques for ocular artefact removal, *IEE E Proc. Sci. Meas. Tech.*, pp: 120.
- Whitton, J.L., F. Lue and H. Moldofsky, 1978. A spectral method for removing eye-movement artifacts from the EEG, *Electroencephalography and Clin. Neurophysiol.*, 44: 735-741.
- Verleger, R., T. Gasser and J. Mocks, 1982. Correction of EOG artifacts in event-related potentials of EEG: Aspects of reliability and validity. *Psychophysiology*, 19: 202-480.
- Vorobyov S. and A. Cichocki, 2002. Blind noise reduction for multisensory signals using ICA and subspace filtering, with application to EEG analysis, *Biol. Cybernetics*, 86: 219-223.