

## Bend Discontinuities with Emphasis on Annular and C-Bends an Analysis Using IE3D and Ansoft

D. Sriram Kumar, Vignesh Sundaram, Arpit Raj and Anand Krishnan  
Department of Electronics and Communication Engineering,  
National Institute of Technology, Tiruchchirapalli, Tamil Nadu, India

**Abstract:** This study analyses and simulates basic bend discontinuities like right angled bends, chamfered bends etc. However, special emphasis has been laid on the analysis of the Annular bend discontinuity and a new novel discontinuity known as C-bend discontinuity. The simulation was carried out using IE3D Method of Moments based electro-magnetic simulation tool. The annular bend discontinuity was simulated on a coplanar waveguide with substrate. Thickness = 7 mm and relative permittivity = 1.5. The dimensions are = 1.125 mm and  $w = 1.125$  mm. The inner radius of the annular bend is 0.3 mm and the outer radius is 0.4 mm. The novel C-bend discontinuity is designed on a coplanar waveguide of substrate thickness = 7 mm and relative permeability of  $\xi = 1.5$  and inner and outer radius of C bend are 3 and 4 mm, respectively. Here also the results obtained are similar to annular bend and device can be operated at ultra wideband frequency.

**Key words:** IE3D, MoM, Annular Bend, C-bend, UWB, right angled bends, chamfered bend

### INTRODUCTION

A conventional CPW on a dielectric substrate consists of a center strip conductor with semi-infinite ground planes on either side (Fig. 1). This structure supports a quasi-TEM mode of propagation (Wen, 1969). The CPW offers several advantages over conventional microstrip line: 1st, it simplifies fabrication; 2nd, it facilitates easy shunt as well as series surface mounting of active and passive devices (Simmons, 2001). Third, it eliminates the need for wraparound and via holes and 4th, it reduces radiation loss. Furthermore the characteristic impedance is determined by the ratio of  $a/b$ , so size reduction is possible without limit, the only penalty being

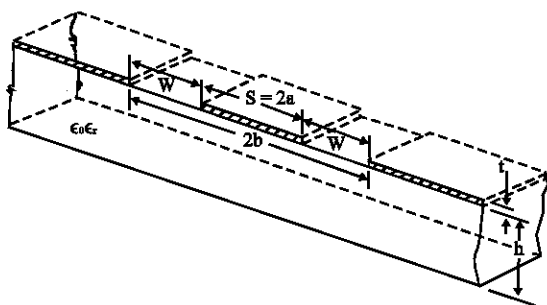

Fig. 1: Schematic of a Coplanar Waveguide (CPW) on a dielectric substrate of finite thickness

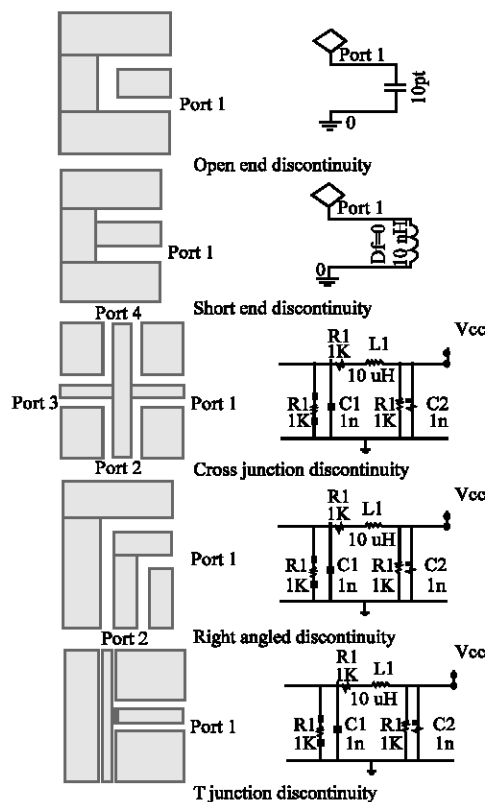

Fig. 2: Types of discontinuities

higher losses. As a result, CPW circuits can be made denser than conventional microstrip circuits. So, CPW is ideally suited for MIC as well as MMIC applications.

It is an abrupt change of geometrical parameters or the material parameters in a homogeneous CPW that results in realization of circuit elements via discontinuities (Fig. 2). At low frequencies these discontinuities behave as ideal connections between the different CPW's. However, at higher frequencies their properties vary.

### MATERIALS AND METHODS

**Bend discontinuities:** This study involves the analysis and modeling of right angled, chamfered, annular and C bend discontinuity (Fig. 3). All these are simulated using IE3D and mathematically modeled using Method of Moments (MoM) technique. Bend discontinuity cannot be simulated on ANSOFT due to size constraint. These are generally formed as a result of alteration of the geometry of CPW discontinuity.

**Air bridge:** Air bridges are used in CPW based circuits to suppress the parasitic capacitances and to provide DC bias to active devices (Omar and Chou, 1992). There are 2 types of air bridges. This study analyses, the characteristics of type-A air bridge with open and short end discontinuities (Fig. 4 and 5).

The excess capacitance in Type-A air bridge is due to the parasitic parallel plate capacitance formed by the air bridge and the center strip conductor (Wu *et al.*, 1995). The air bridge height is the dominating factor affecting the bend. Increasing it reduces  $|S_{11}|$  and increases  $|S_{21}|$  until almost perfect transmission is achieved for  $H > 8 \mu\text{m}$ .

**Method of Moments (MoM):** Both IE3D and ANSOFT (HFSS) are based on MoM's Boundary Element Method (BEM) (Harrington, 1993). Boundary element method involves the creation of integral equations whose solution is the answer. BEM creates a mesh like structure over the modeled surface (Lebanon, 2006). These meshes are further modeled as matrices, which are solved numerically. This is done using Green's Functions (Dib and Katehi, 1992). Green's Functions consist of source and field patches, which form the matrix. Green's Functions are integrated over wither or both source and field patch if the model is uniform throughout. This is called Galerkin's Method. For simple geometries analytical integration is used. For complex geometries they are broken down into simpler geometries and are separately integrated over.

IE3D breaks down the structure to be modeled into numerous meshes whose co-ordinates are modeled as a

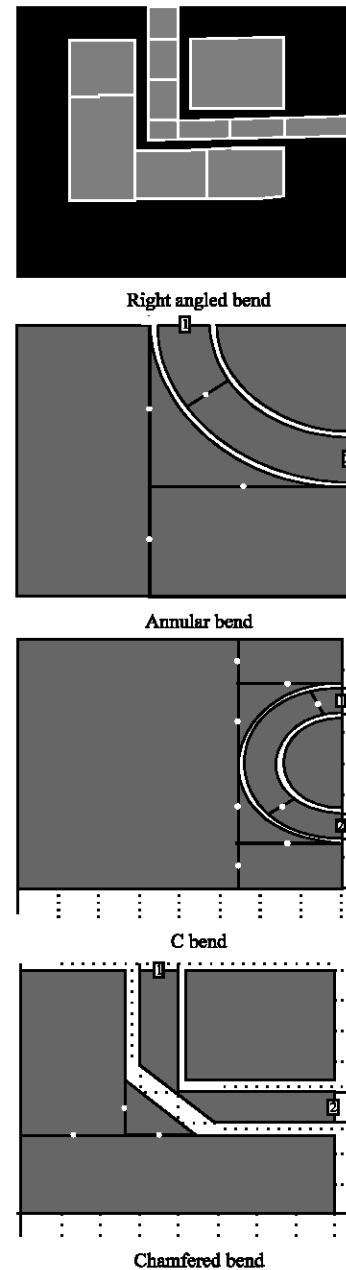

Fig. 3: Bend discontinuities

matrix. It calculates the analytical integral over all these meshes by filling the matrix elements for every single frequency. This sometimes is a time consuming process, hence sometimes BEM is less efficient than other volume-discretisation methods like FEM or FDM, etc. (Newman, 1988).

Technically, a Green's function,  $G(x, s)$ , of a linear operator  $L$  acting on distributions over a manifold  $M$ , at a point  $s$ , is any solution of

$$LG(x, s) = \delta(x - s) \quad (1)$$

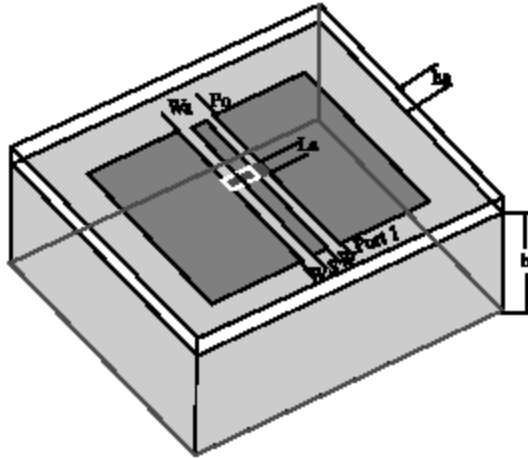

Fig. 4: Air bridge (type-A)

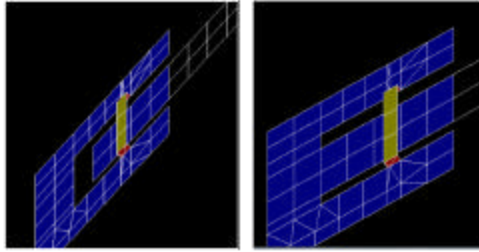

Fig. 5: Open and short end with air bridge

where,  $\delta$  is the dirac delta function. This technique can be used to solve differential Eq. 2 of the form:

$$Lu(x) = f(x) \quad (2)$$

Suppose the function  $v(t)$  is known over the domain of  $t$ , specific values of  $x$  may be derived from a representative expressions, such as Eq. 2.

$$x = \int_0^t v(t) dt \quad (3)$$

For example, if  $v(t) = k$ ,  $x = kt$ . A special case arises when the function  $v(t)$  is unknown and values of  $x$  are known at only discrete values of  $t$ . This type of problem is generally referred to as an integral equation problem where the task is to determine the function. The fundamental concept behind the MoM employs orthogonal expansions and linear algebra to reduce the integral equations problems to a system of simultaneous linear equations.

The following procedure shows how to find current expansion coefficient using McFadden(1989). We define

the unknown current distribution in the electromagnetic field as  $I_z(z')$ . The current distribution is expressed as:

$$\sum_{n=1}^N C_n G_n(z) = E_z(z) \quad (4)$$

Where:

$$G_n(z) = \frac{1}{j4\pi\omega\epsilon} \int_{-l/2}^{l/2} F_n(z') \left[ \frac{\partial^2}{\partial z'^2} + k^2 \right] \frac{e^{-\gamma_n R}}{R} dz'$$

$C_n$  = Current's expansion coefficient

$F_n(z')$  = Basis function

After applying the boundary conditions, we get a set of integral equations defined by:

$$[Z_{mn}] [I_n] = [V_m] \quad (5)$$

where:

$$Z_{mn} = \int_{-l/2}^{l/2} H_m(z) G_n(z) dz'$$

$$I_n = C_n$$

$$V_m = \int_{-l/2}^{l/2} H_m(z) E_z(z) dz'$$

This circuit like set of simultaneous equations will lead to the value of  $C_n$ .

$$[I_n] = [Z_{mn}]^{-1} [V_m] \quad (6)$$

## RESULTS AND DISCUSSION

All the Fig 6-21 represent the VSWR and loss parameters of various discontinuities obtained on simulation using IE3D. Simulation results are tabulated as shown in Table 1.

As shown in the Table 1, the novel C-Bend discontinuity is found to have loss parameters varying from -36 to -9 dB (for 0-12 GHz) and VSWR varying from 1-2.2 (for 0-12 GHz). This shows that the device having this discontinuity can be suitably used in Ultrawide Band Frequencies (UWB). Similarly annular bend on IE3D simulation leads to results which prove that it can act in a UWB frequency range. Loss parameters vary from -45 to 10 dB (for 0-15 GHz) and VSWR vary from 1-2 (for 0-16GHz). Similarly right angled bend on ANSOFT simulation leads to results which prove that it can act in a frequency range greater than UWB (Omar *et al.*, 1992). Loss parameters vary from -24 to -14 dB (for 0-30 GHz) and VSWR from 1.1-1.5 (for 0-30 Ghz).

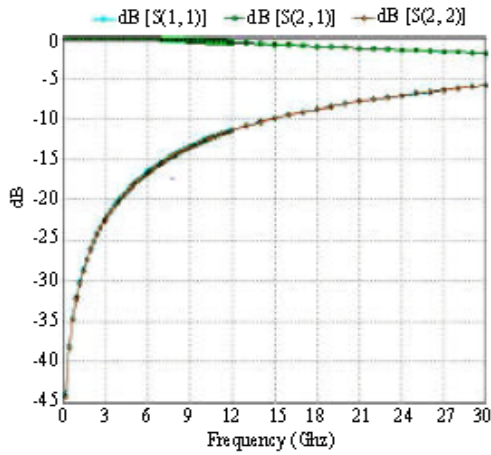

Fig. 6: S parameters for Annular B end

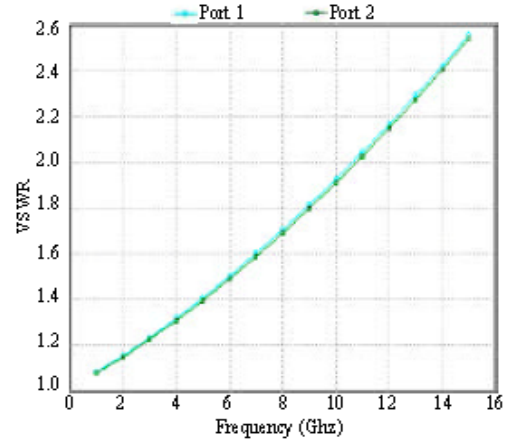

Fig. 9: VSWR for C-B end

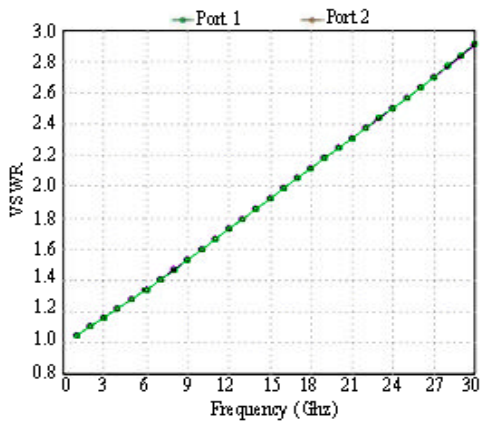

Fig. 7: VSWR for Annular Bend

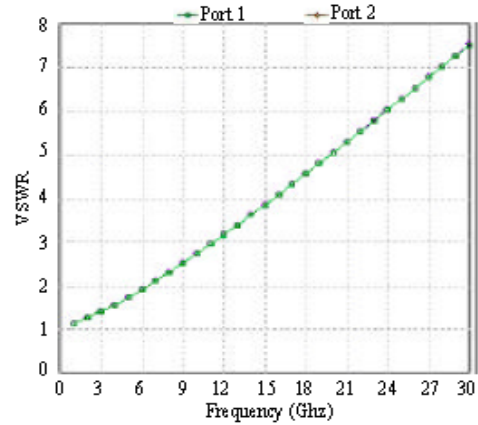

Fig. 10: VSWR for Chamfered B end

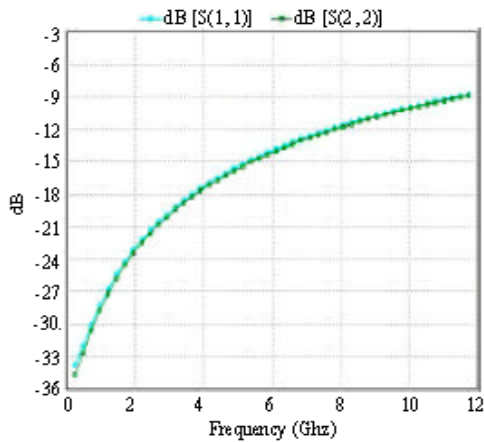

Fig. 8: S parameters for C-B end

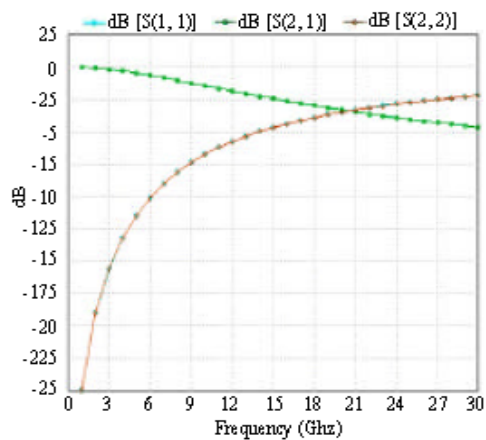

Fig. 11: S parameters for chamfered bend

However, chamfered bend on IE3D simulation shows that it can research only in Wide Band frequency (WB)

(3-6 GHz). Loss parameter varies from -24 to -10 dB (for 0-6 GHz) and VSWR varies from 1.1-2 (for 0-6 GHz). All

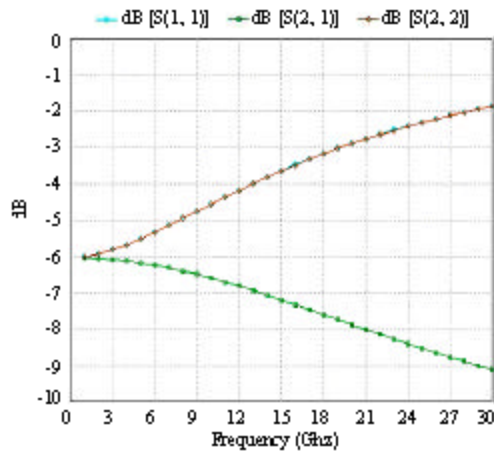

Fig. 12: S parameters for Cross Junction

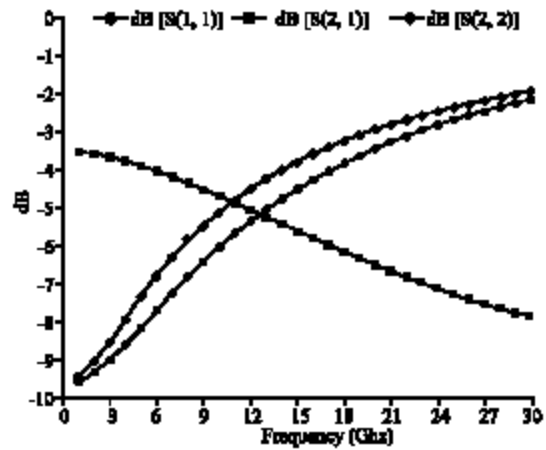

Fig. 15: S parameters for T-Junction

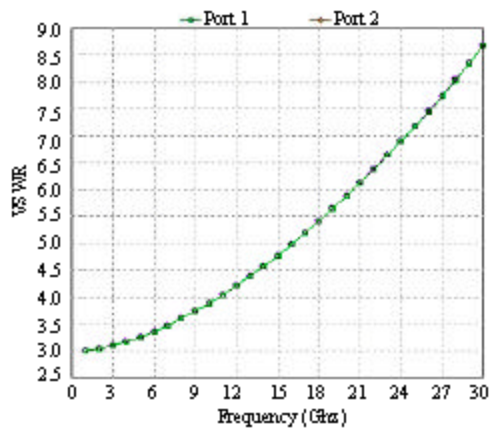

Fig. 13: VSWR for Cross Junction

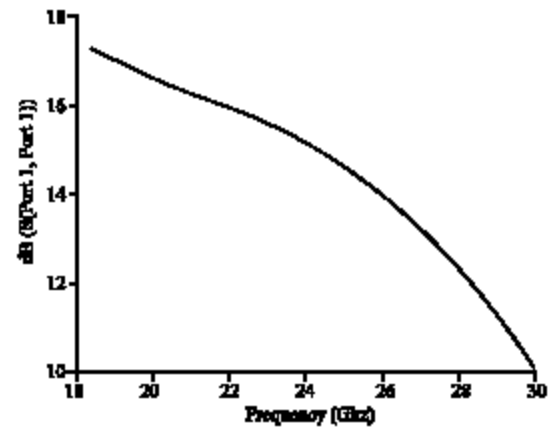

Fig. 16: S parameters for Open End

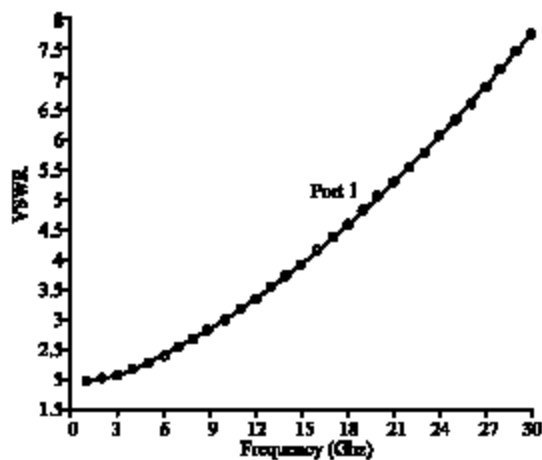

Fig. 14: VSWR for T-Junction

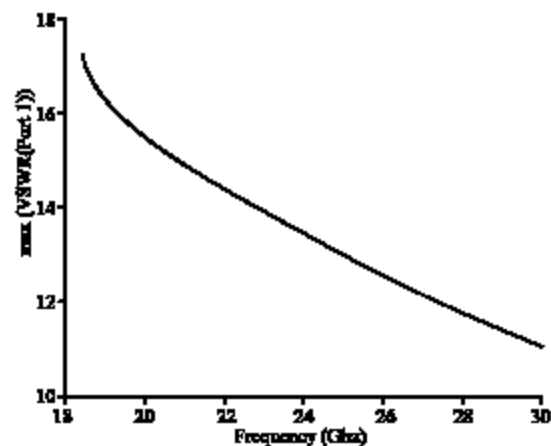

Fig. 17: VSWR for T-Junction

the other discontinuities namely short, open, T-junction, cross junction etc are found out to be less efficient than

bend discontinuities in UWB and wide band frequency application (CPW reconfigurable and CPW discontinuity UWB antennas).

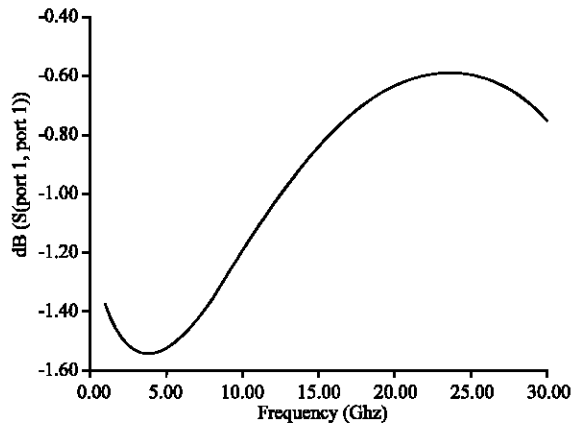

Fig. 18: S parameter for short end

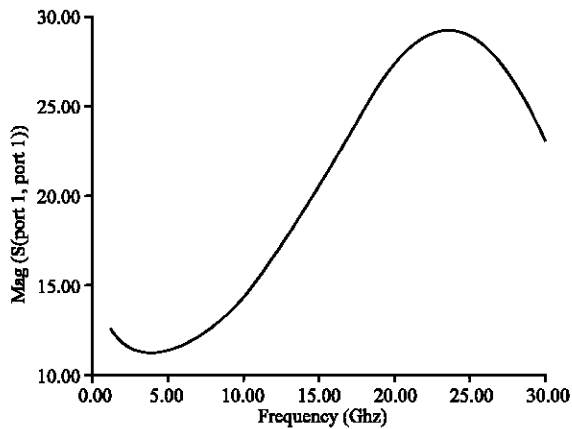

Fig. 19: VSWR for short end

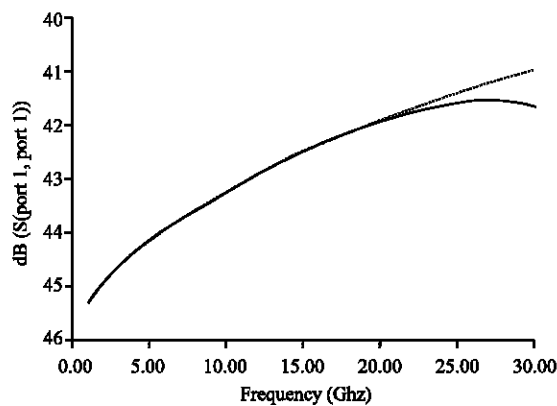

Fig. 20: S parameters for right angled

**Note:** Optimum value of VSWR and loss parameter for device operation are 2 and -10 dB, respectively. Table 1 tabulates simulation results for a frequency sweep of 0-30 GHz only. Hence from the Table 1, we infer that devices having bend discontinuities can be operated in

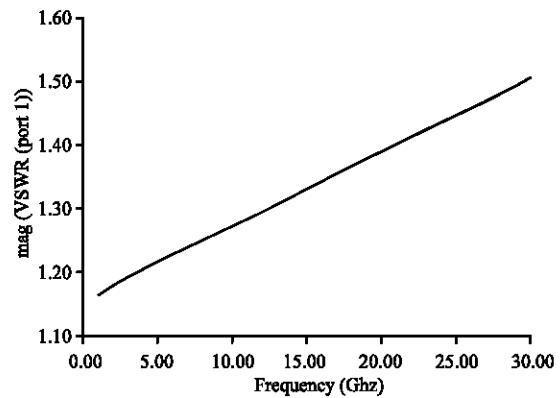

Fig. 21: VSWR for right angled

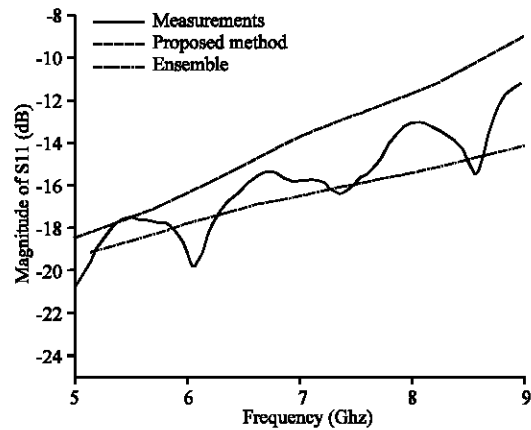

Fig. 22: S-parameter for right angled bend analysis from paper no (Chae *et al.*, 2001)

Table 1: Compilation of results

Type of discontinuity	Loss parameter (dB) (0-30 GHz)	VSWR (0-30 GHz)	Range of operation
C-bend	-36 to -9 (12 GHz)	1-2.2 (12 GHz)	UWB
Annular	-45 to -10 (15 GHz)	1-2 (16 GHz)	UWB
Right angled	-24 to -14	1.1-1.5	>UWB
Chamfered	-25 to -2.5	1-7.5	WB
Open end	-1.4 to -5	14-3.5	---
Short end	-1.4 to -0.8	13-24	---
T-junction	-10 to -2	2-7.6	---
Cross junction	-6 to -2	3-8.8	---

UWB and WB frequencies, which is not the case with open, short, T-junction, cross junction etc.

Moreover, the S-parameters of right angled discontinuity obtained from the simulation are found in agreement with the general S-parameters of the right angled discontinuity from the study (Chae *et al.*, 2001) (Fig. 22).

## CONCLUSION

Hence, bend discontinuities (C Bend, Annular, Right angled, chamfered) are more stable and best used in UWB

and WB frequencies as compared to other discontinuities. Hence, C bend and Annular Bend have potential widespread application in devices operating in UWB frequencies.

#### APPENDIX

**Fabrication of annular bend discontinuity for applications:** The annular bend discontinuity is fabricated on a RT-DUROID substrate of relative permittivity ( $\epsilon = 1.5$ ) and layer thickness = 5 mm. The annular bends inner radius is 0.3 mm and the outer radius is 0.4 mm. This design can be fabricated on a basic conductor backed CPW substrate. The annular bend can be obtained by using METALLIZED VIA HOLES. Fabrication of annular bend discontinuities for antenna applications (CPW reconfigurable and discontinuity antennas) as bend discontinuities are stable over UWB and WB frequencies.

#### REFERENCES

- Chae, C.B., J.P. Lee and S.O. Park, 2001. Analytical asymptotic extraction technique for the analysis of bend discontinuity. *Progress Electromagnet. Res. (PIER)*, 33: 219-235.
- Dib, N. and L.P.B. Katehi, 1992. Theoretical Characterization of Coplanar Waveguide Transmission Lines And Discontinuities.
- Harrington, R.F., 1993. *Field computation by moment methods*. IEEE Press Series on Electromagnetic Waves.
- Lebanon, G., 2006. The Method of Moments Estimator. 12th May.
- McFadden, D., 1989. A method of simulated moments for estimation of discrete response models without numerical integration, 57(5): 995-1026.
- Newman, E.H., 1988. Simple examples of method of moments in electromagnetics. *IEEE. Transaction on Education*, Vol. 31. 3rd August.
- Omar, A.A. and Y.L. Chou, 1992. A solution of CPW with air bridges using complex images. *IEEE. Trans. Microwave Theory Technol.*, MTT-40 (1): 2070-2077.
- Simmons, R.N., 2001. *Coplanar Waveguide Circuits, Components and Systems*, Wiley-Interscience, Pub.
- Wen, C.P., 1969. Coplanar waveguide, a surface strip transmission line suitable for non-reciprocal gyromagnetic device applications. *IEEE. Trans. Microwave Theory Technol.*, Vol. MTT-17, No. 12.
- Wu, M. *et al.*, 1995. Full-wave characterization of the mode conversion in a CPW right angled bend. *IEEE. Trans. Microwave Theory Technol.*, 43: 2532-2538.