

In-Cylinder Mass Flow Rate and Gas Species Concentration Simulation of Spark Ignition Engine

N.M.I.N. Ibrahim, Semin, Rosli Abu Bakar, Abdul Rahim Ismail and Ismail Ali
Automotive Excellent Center, Faculty of Mechanical Engineering, University Malaysia Pahang,
Locked Bag 12, 25000 Kuantan, Pahang, Malaysia

Abstract: The objective of this research, is to simulate the in-cylinder mass flow rate for a single cylinder two-stroke spark ignition internal combustion engine. The research describes the Computational Fluid Dynamic (CFD) analysis technique to predict in-cylinder flow on scavenging process. The modeling of three-dimensional solid of scavenging model was developed using Solidwork computer aided design software. The three-dimensional model is imported to the GAMBIT to generate meshes grids and imported to FLUENT software for modeling analysis. This analysis is using the dynamic mesh approaches using unstructured tetrahedral and layered hexahedral elements simulated from Top Dead Center (TDC) at 0° of crank angle. Parameter of pressure is used as boundary condition collected from the experimental results at the intake port. The engine modeling simulates on motored condition for un-firing cases at difference of engine speed. The results shown that, using the dynamic mesh approaches give confident results compared with experimental. The results have been predicted of mass flow rate and mass fraction of burned gases on engine cylinder. Contour plotted of mass fraction burned gases and vector of velocity was plotted.

Key words: Computational fluid dynamics, contour plotted, mass flow rate, mass fraction, spark ignition engine

INTRODUCTION

The Internal Combustion (IC) engines date back to 1876 when Nicolaus A. Otto first developed the spark-ignition engine and 1892 when Rudolf Diesel invented the compression-ignition engine (Heywood, 1988). Since then, many researches have focused on the combustion process. Contemporary engine research has attempted to maximize the power produced from fuel combustion while minimizing pollutants and other regulated compounds. The difficulty is that there exist many variables that affect these treatments, the piston speed, the piston chamber geometry, inlet and exhaust port design, fuel composition, in-cylinder fluid dynamics and ignition devices used. A comprehensive and detailed study is needed to embrace all the factors.

In two-stroke cycle engines, each outward stroke of the piston is a power stroke. In order to achieve this two-stroke, the fresh charge must be supplied to the engine cylinder at a high-enough pressure to displace the burned gases from previous cycle. The operation of clearing the cylinder of burned gases and filling it with fresh mixture combination between intake and exhaust process is known as scavenging. The emphasis of this research is

lied in prediction of scavenging characteristics using numerical approaches. Using the BG-238A Tanika engine a made single cylinder two-stroke loop-scavenged, this study focus on effects of boundary conditions at different speed. From the experimental data, the inlet and cylinder pressure were measured at 1100, 1400 and 1700 rpm. The new engine test-rig is developed included the Data Acquisition System (DAS) and sensors. The scavenging process in the two-stroke engine has direct influence on engine performance on their combustion processes and remains one of the important strategies towards improvement of fuel efficiency and reduction of pollutant.

The in-cylinder fluid motion in internal combustion engine is one of the vital factors that controlling the combustion process. The design of port system either the intake or exhaust ports of two-stroke engine is very influential in the in-cylinder flows. However, it also resulted in the short-circuiting of fresh charge. The short-circuiting phenomena are responsible for the lower fuel efficiency and high hydrocarbons emission. Previous researchers did not clearly state how the experimental data employed in numerical approach. Data is taken from the intake port and applied as pressure average and solve through the numerical approach. The effects of pressure

will be investigated thoroughly. The detail of this study is presented in this research using Fluent as CFD software.

Any researchers used CFD model to investigate the engine performance. The structure and guiding philosophy behind this theoretical package has been described by their originators (Spalding, 1981; Gosman, 1985). These CFD codes are developed for the simulation of a wide variety of fluid flow process. They can be analyzed steady or unsteady flow, laminar or turbulence flow, flow in two or three dimensions and single or two phase flow. One approach to the solution of the turbulence flow is often referred to as a k-ε model to estimate the effective viscosity of the fluid. A typical computational grid structure employed for an analysis of scavenging flow in a two-stroke engine (Wolfgang *et al.*, 2000). The model simulated on half model because the geometries are symmetry. Multidimensional computational is used method to investigate the details of the in-cylinder flow and gas exchange process in a loop scavenged SI engine. The inlet and outlet boundary conditions were obtained from a gas dynamic calculation. Results shows the in-cylinder flow structure early during the scavenge phase comprise of a three dimensional (Ahmadi *et al.*, 1989).

There are any software were used for CFD modeling (Amsden *et al.*, 1992; Kang *et al.*, 1993; Liu *et al.*, 1996; Raghunathan and Kenny, 1997; Elligott *et al.*, 1999; Hori *et al.*, 1995; Mugele *et al.*, 2001; Fadzil *et al.*, 2004; Bakshi *et al.*, 2004; Tulus *et al.*, 2006). From the number of review research have been published, it is suggested that the scavenging process is still regarded as one of the leading problem in two-stroke engine issues. There are typically two method available to investigate scavenging characteristics, i.e., through experimental or numerical methods. Experimental methods can provide real measured data and can be trustworthy. However, the experimental methods are expensive and take a long time to turn around a solution. Numerical methods, in particularly finite volume method, a general method using for the fluid flow problems. Based on literature studies, Laser becomes more significant tool for experimental purpose especially on fired tests. It is clear that for the more accurate results laser application well establish is used by among researchers. Alternatively, numerical approach which is computational fluid dynamics also becomes more popular to solve the flows characteristics. There are several unique advantage of CFD over experimental based approaches to fluid systems design, substantial reduction of lead times and costs of new designs, ability to study systems where controlled experiments are difficult or impossible to perform, ability to study under hazardous

conditions at and beyond their or impossible performance limit and practically unlimited level of detail of results.

Scavenging in loop-scavenged two-stroke engine-cycle engines has been the subject of several recent experimental and multidimensional studies. The computational domain comprises the in-cylinder region only: inlet and outlet boundary conditions have been specified at the interfaces of the transfer and exhaust ports with the cylinder wall. In order to study the scavenging process, the numerical study will be introduced for the loop-scavenged type single two-stroke engine. The multi block approach is seen more effective with the dynamic mesh of transient analysis. The boundary condition from experimental data will be introduced which has not been clearly published by previous researchers and use for the three dimensional analysis. The combination with selected papers from previous researchers as mentioned before has given the ideal to study the effects of in-cylinder flows characteristics with different of variations pressures.

MATERIALS AND METHODS

The engine used a single cylinder piston-ported two-stroke engine loop-scavenged crankcase compressed. This research has conducted at Automotive Laboratory, University Malaysia Pahang, in 2005 until 2007 years. The specifications of engine are shown in Table 1. The piston surface is flat form.

The analysis of Computational Fluid Dynamics (CFD) three dimensional models was constructed using the FLUENT code and it ability to deal with multi-block solution domains with moving wall. The computational domain was produced based on the actual engine and run for half model. The finite volume enclosed the domain started from the intake port and ended at the exhaust port locations. The analysis is limited for motored condition for scavenging processes.

Due to the symmetry of the cylinder port layout, it was only necessary to model half of the geometry (Laurine *et al.*, 1994; Wolfgang *et al.*, 2000). Figure 1 shows such a three-dimensional for half model two-stroke engine. The main components included cylinder head and piston. The basic geometry of this engine illustrated on

Table 1: Engine specifications

Parameter	Size/Feature
Cylinder type	Single cylinder, piston ported
Compression type	Crankcase compression
Displacement	30.5 cm ³
Scavenging concept	Multi port-Loop scavenged
Bore × Stroke	36×30 mm
Exhaust port opening/closing	101 CA ATDC/259 CA ATDC
Scavenged port opening/closing	140 CA ATDC/220 CA ATDC

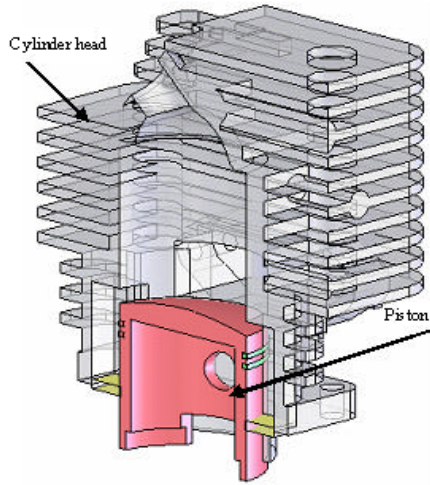

Fig. 1: Half model three-dimensional of engine

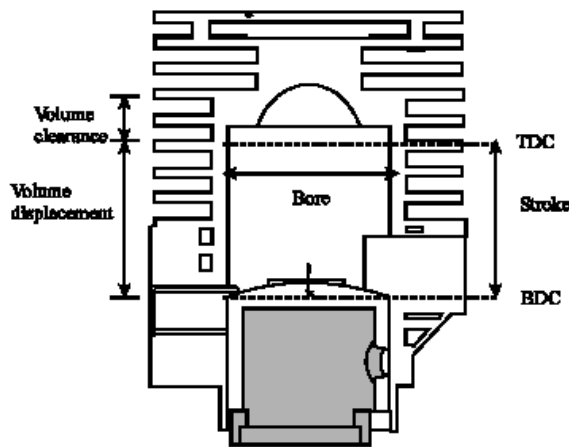

Fig. 2: Engine dimension parameters

Fig. 2. The mesh was constructed using three separate blocks representing the intake port, cylinder and exhaust port of the engine. Their cell faces at the interface between each other matched exactly setting in the TGRID stage. The overall mesh structure for the piston at the TDC is shown in Fig. 3. The overall comprising 7964 cells for the whole components started simulate at the TDC position.

The volume is divided and the mesh to fulfill the requirement of the dynamic mesh transient analysis. Layered hexahedral meshed is specified for moving part and unstructured tetrahedral element was for stationary region. Volume grid generation was established using Gambit 2.16 Pre-processor and TGrid. Block-by-block approach is used to mesh the separated computational domain (Fluent, 2001; Fadzil *et al.*, 2003; Bakshi *et al.*, 2004; Tulus *et al.*, 2006). The procedure is illustrated in Fig. 4 for a simple two-dimensional case undergoing

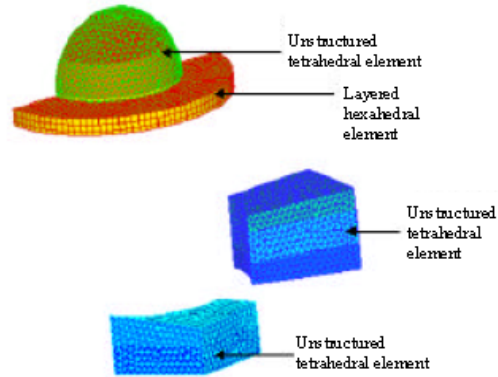

Fig. 3: Volume grid

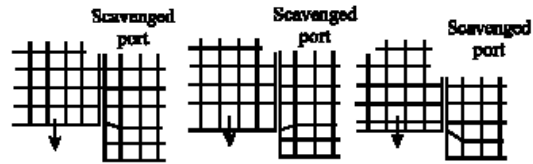

Fig. 4: Mesh motion for expansion (Ragunathan and Kenny, 2000)

expansion and is similar to the 'snapper' logic adopted by Amsden (1992).

The lowest layer of vertices in the cylinder mesh was always maintained to be at the piston crown level. Additional layers of cells within the cylinder were activated until achieved at the BDC. A layer of vertices was also required to be moved in the scavenged port to ensure that the cell faces of the cylinder and scavenged matched at the port also exhaust itself. In each case, a datum mesh was read in at the start of each time step and mesh motion program modified the datum mesh to that required at the end of time step. In this case, that setting of time step mesh motion start at TDC and until to BDC for one and half cycle. The start moving at TDC is shown in Fig. 5.

Using FLUENT, it is provided a built-in function to calculate the piston location as a function of crank angle. Using this function, it is needed to specify the piston stroke and connecting rod length. The piston location is calculated using the following expansion.

$$p_s = L + \frac{A}{2}(1 - \cos(\theta_c)) - \sqrt{L^2 - \frac{A^2}{4} \sin^2(\theta_c)} \quad (1)$$

Where, p_s is piston position (0 at TDC) and A at BDC, L is connection rod length, A is piston stroke and θ_c is current crank angle position. The current crank angle is calculated as below:

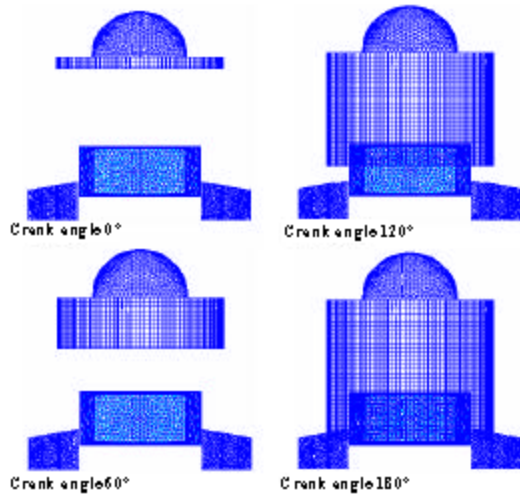

Fig. 5: Mesh motion preview start from TDC to BDC to verify the mesh motion step

$$\theta_c = \theta_i + t\Omega_{shaft} \quad (2)$$

Where, θ_i is the starting crank angle and Ω_{shaft} is the crankshaft speed. The three mesh update procedures available are dynamic layering, local remeshing and spring smoothing. In this case, only dynamic layering method is applicable since the grid, which was built, is based on layered hexahedral element. Stationary zones were maintained intact for update.

The integral form of the conservation equations (Fluent, 2001) for a general scalar, ϕ on an arbitrary control volume, V , whose boundary is moving can be written below:

$$\frac{d}{dt} \int_V \rho \phi dV + \int_{\partial V} \rho \phi (\vec{u} - \vec{u}_e) \cdot d\vec{A} = \int_{\partial V} \Gamma \nabla \phi \cdot d\vec{A} + \int_V S_\phi dV \quad (3)$$

Where, ρ is the fluid density, \vec{u} is the flow velocity vector, \vec{u}_e is the grid velocity of the moving mesh, Γ is the diffusion coefficient and S_ϕ is the source term if ϕ . Here is used to represent the boundary of the control volume V . The time derivation term in Eq. 3 can be written using a first-order backward difference formula as:

$$\frac{d}{dt} \int_V \rho \phi dV = \frac{(\rho \phi V)^{n+1} - (\rho \phi)^n}{\Delta t} \quad (4)$$

Where, n and $n + 1$ denote the respective quantity at the current and next time level. The $(n + 1)$ th time level volume is computed from

$$V^{n+1} = V^n + \frac{dV}{dt} \Delta t \quad (5)$$

Where, dV/dt is the volume time derivative of the control volume. In order to satisfy the grid conservation law, the volume time derivative of the control volume is computed from

$$\frac{dV}{dt} = \int_{\partial V} \vec{u}_e \cdot d\vec{A} = \sum_i^n \vec{u}_{e,i} \cdot \vec{A}_i \quad (6)$$

Where, n , the number of faces on the control volume and \vec{A}_i is the j face area vector. The dot product $\vec{u}_{e,i} \cdot \vec{A}_i$ on each control volume face is calculated from

$$\vec{u}_{e,i} \cdot \vec{A}_i = \frac{\delta V_i}{\Delta t} \quad (7)$$

Where, δV_i is the volume swept out by the control volume face over the time step Δt .

The fluid passing through the engine was set to be air and was allowed to be compressible by the inclusion of the solution of enthalpy, the density was calculated through the use of the ideal gas law. The calculation utilized the standard version of the $k-\epsilon$ turbulence model. Here, the species transport model is activated with two phase conditions being defined as burned and unburned. The properties of two species could difference, it is simply because both are given the same properties as those of fresh air.

Boundaries through which flow can enter and leave the solution domain exit at the entry to the intake ports from the crankcase and exit of the exhaust port to atmosphere. The Boundary Condition (BC) at the intake ports were measured from experimental using complete test-rig shown at Fig. 6. The three cases of study were selected which is from experimental data at the inlet port. From the profile data, the BC was divided to the different cases of speeds are listed in Table 2.

The flow at the exit of the exhaust port to atmosphere was set to constant static pressure equal to atmospheric pressure (Yasou *et al.*, 2000; Franz *et al.*, 1998). The simulation of this engine started at the 0° at the Top Dead Centre (TDC). The cylinder was initialized with a inlet pressure used which is listed in Table 2 and the wall temperature was fixed at 300K. Yasou *et al.* (2000) was used the turbulence intensity and scale at both intake port entrance and exhaust port exit was set at 10 % of mean velocity and 2 mm, respectively.

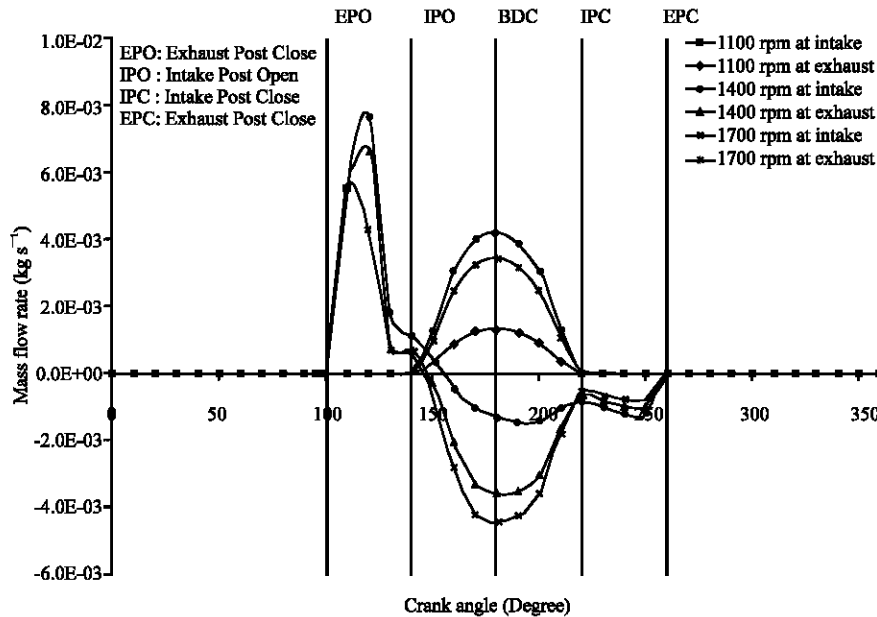

Fig. 6: Effect of mass flow rate in cylinder at different engine speed and porting

Table 2: Parameters of pressure inlet

Input (speed)	Pressure (Bar)
1100 rpm	1.168827
1400 rpm	1.117897
1700 rpm	1.029336

RESULTS AND DISCUSSION

The amount of mass flowing through a cross per unit time is called mass flow rate. A gas flows or a liquid in and out of a control volume through pipes or ducts. Figure 6 shows the relationship mass flow rate as a function of crank angle degree. The positive and negative values characterize the flow of air in the cylinder. Positive values means fresh charge enters to the cylinder and negative values represents the motion of fresh charge is exiting the cylinder. At the beginning of the simulation, the all value of mass flow rate there no entering or exiting occurs in the cylinder until at exhaust port started open (IPO) at 101° ATDC, the burned gases enter to cylinder due to the backflow pressure.

At the speed 1700 rpm it is shown a higher mass flow rate value compared to other. While the intake port is started to open (IPC) at 140° ATDC, the mass flow rate is start to enter the cylinder and exiting through the exhaust port. At this time, fresh charge enters the cylinder and gave the higher value of mass flow rate. The maximum of mass flow rate is achieved when the piston at BDC. This is due to the intake port fully opened and fresh charge enter to cylinder when crankcase under compression. At the Intake Port Close (IPC), there is no entering and

exiting occurs in the cylinder. Figure also shows the small amount of mass flow rate at 220° ATDC. When the Exhaust Port Close (EPC), there is no flows entering or exiting occur cylinder.

The performance of a two-stroke engine is strongly dependent on how well the burnt gases are scavenged from cylinder volume and replaced with fresh charge. Improve scavenging will minimize losses of fresh charge to the exhaust port through the short-circuiting and engine with premixed charge will be reduced the hydrocarbon emissions and fuel consumption. To determine the properties of a mixture in cylinder, the composition of the mixtures as well as properties is important. Generally, the mass fraction is the ratio of the mass of a component to the mass of the mixture. In cylinder analysis, the mass fraction divided to components; mass fraction burned and fresh air. At the early of simulation, the in cylinder and exhaust port defined by burnt area and intake port as fresh charge. Value 1 defined the area of burnt and 0 for fresh charge. This parameter can be effected the cylinder characteristics on real condition.

Figure 7 shows the effect of mass fraction with the crank angle for cylinder area. The characteristics of process started when the position of piston for intake Port Started Open (IPO) at 140° ATDC and ended on Intake Port started Close (IPC) at 220° ATDC. The characteristics of mass fraction showed that the composition of fresh charge and burned gases are balance. This figure clearly shows that total of burned

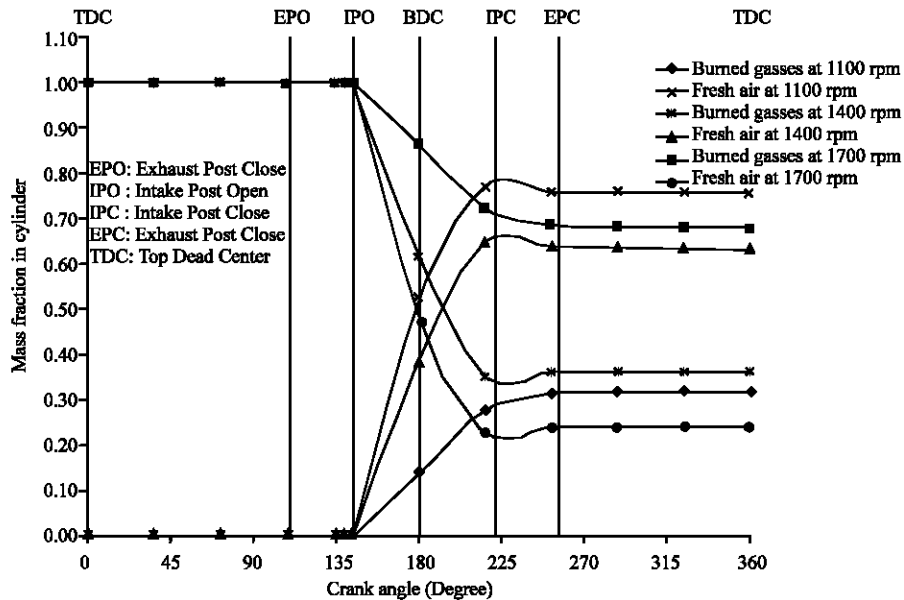

Fig. 7: Effect of mass fraction in cylinder at different engine speed and porting

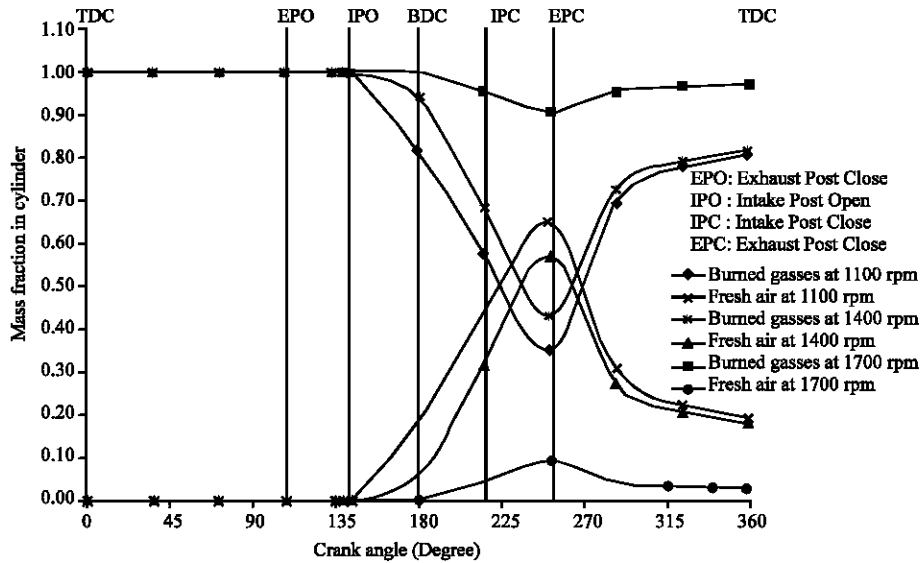

Fig. 8: Effect of mass fraction in exhaust at different engine speed and porting

gases and fresh charge must be equal 1 for all condition. Higher speed of engine gives supply the lower of fresh charge and in this condition the burned gases give a higher value. It also shows that lower engine speed produces higher fresh charge and the balance of burned gases is lower that fresh charge. Generally, it can be concluded that the total area of burned gases will be replaced with the total of fresh charge entering the cylinder at the same amount.

The characteristic of exhaust port becomes one of the concentrated areas of this study to measure the possibility of short-circuiting problems. In the exhaust port, the characteristic of mass fraction was calculated

when the scavenging process in cylinder exit to the exhaust port. The exhaust port gives more information about the overall problem on scavenging process in short-circuiting. Figure 8 shows the effect of mass fraction with the crank angle for exhaust area. From the figure it shows that higher engine speed gives low fresh charge exit through the exhaust area compared at low speed. The lower engine gives the higher amount of fresh charge direct exit through the exhaust area. It can be concluded that the short-circuiting phenomena occur at the lower engine.

Figure 9 and 10 shows the effect of mass fraction for burned gases and fresh charge with the crank angle for

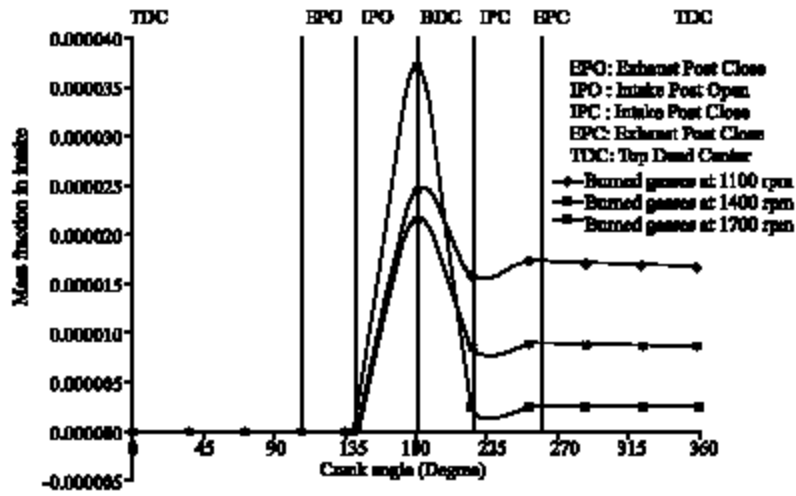

Fig. 9: Effect of mass fraction for burned gases in intake at different engine speed and porting

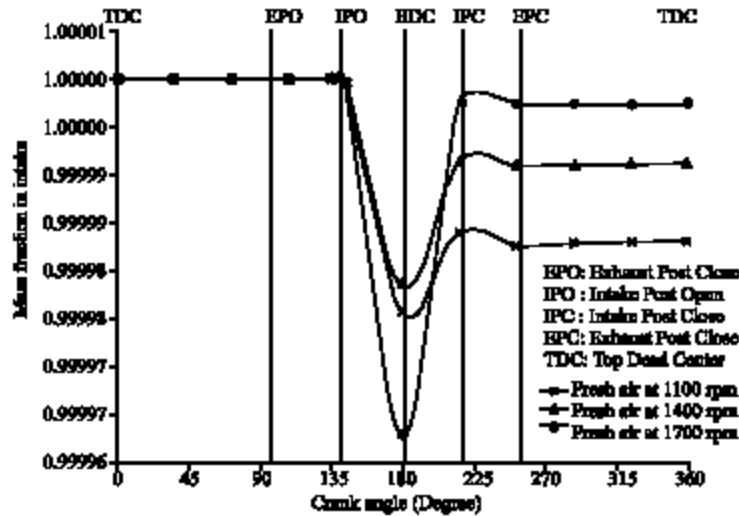

Fig. 10: Effect of mass fraction for fresh charge in intake at different engine speed and porting

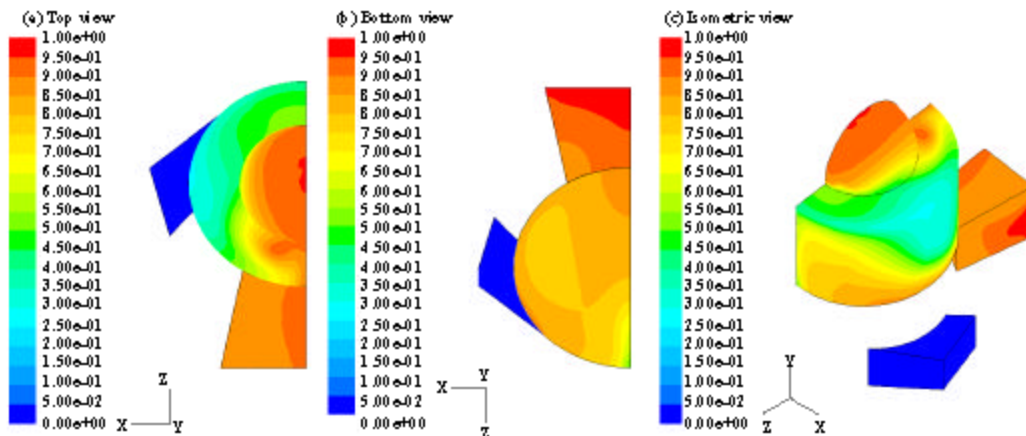

Fig. 11: Temporal charge of gas species concentration at different view

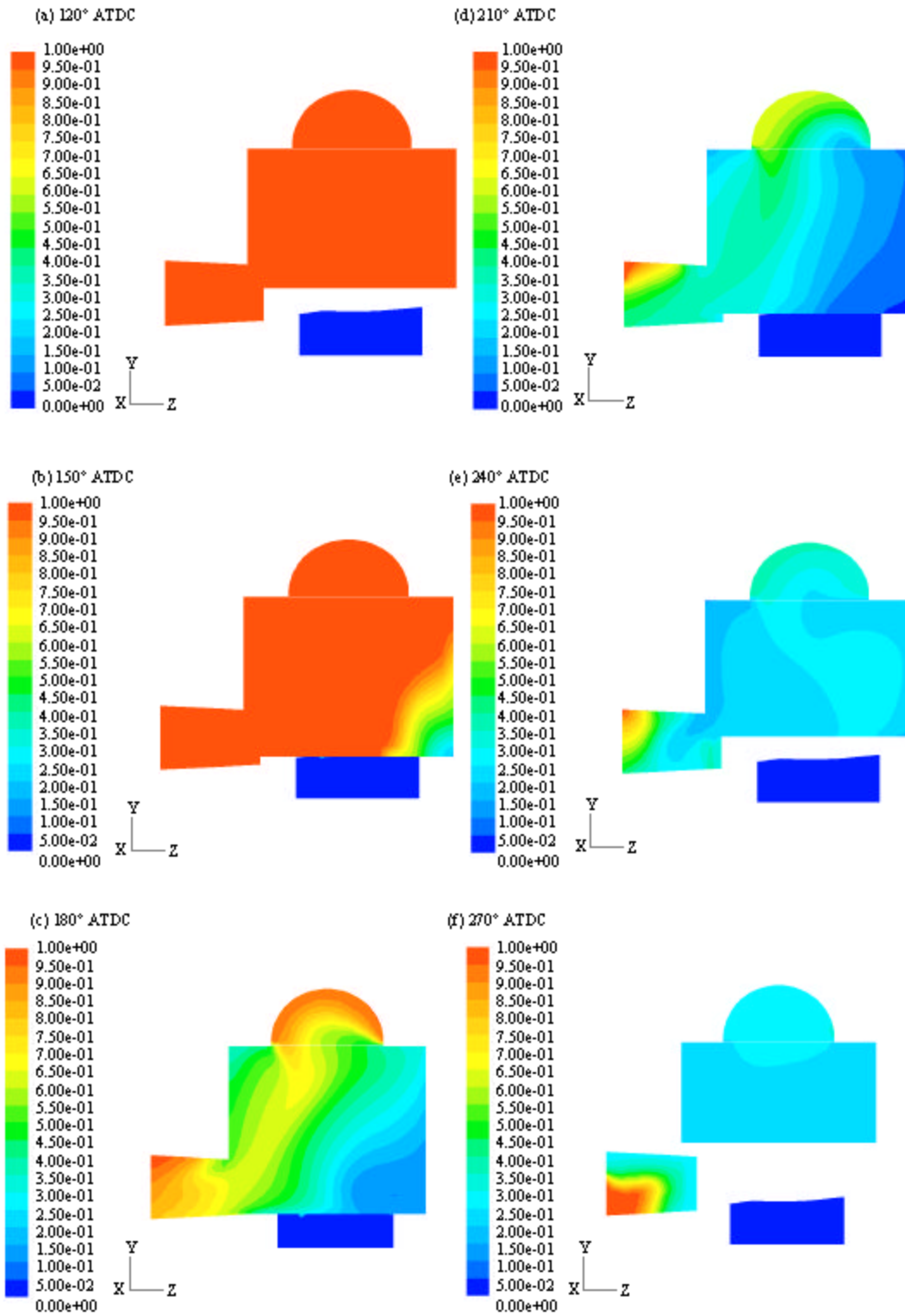

Fig. 12: Temporal change of gas species concentration at 1100 rpm

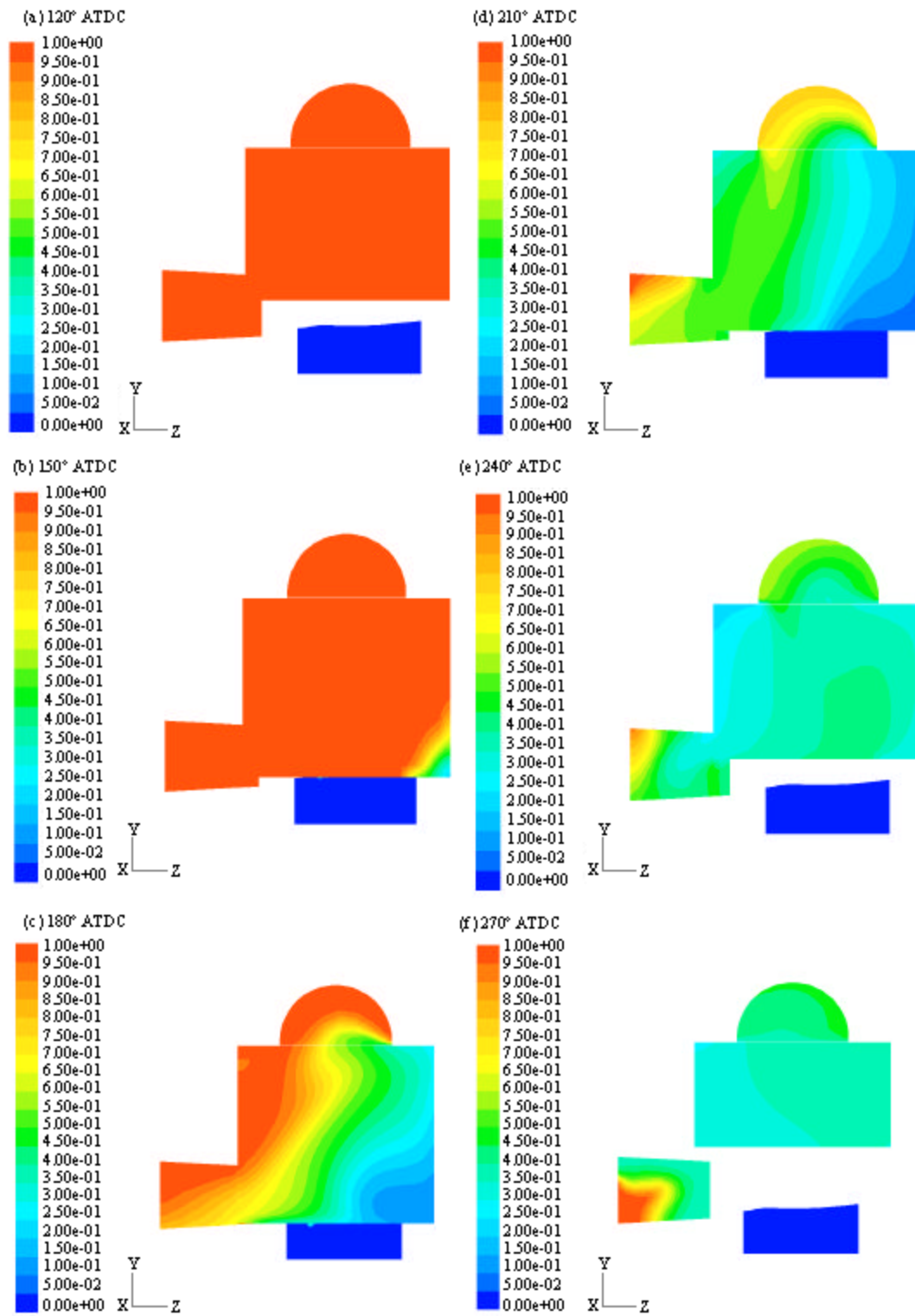

Fig. 13: Temporal change of gas species concentration at 1400 rpm

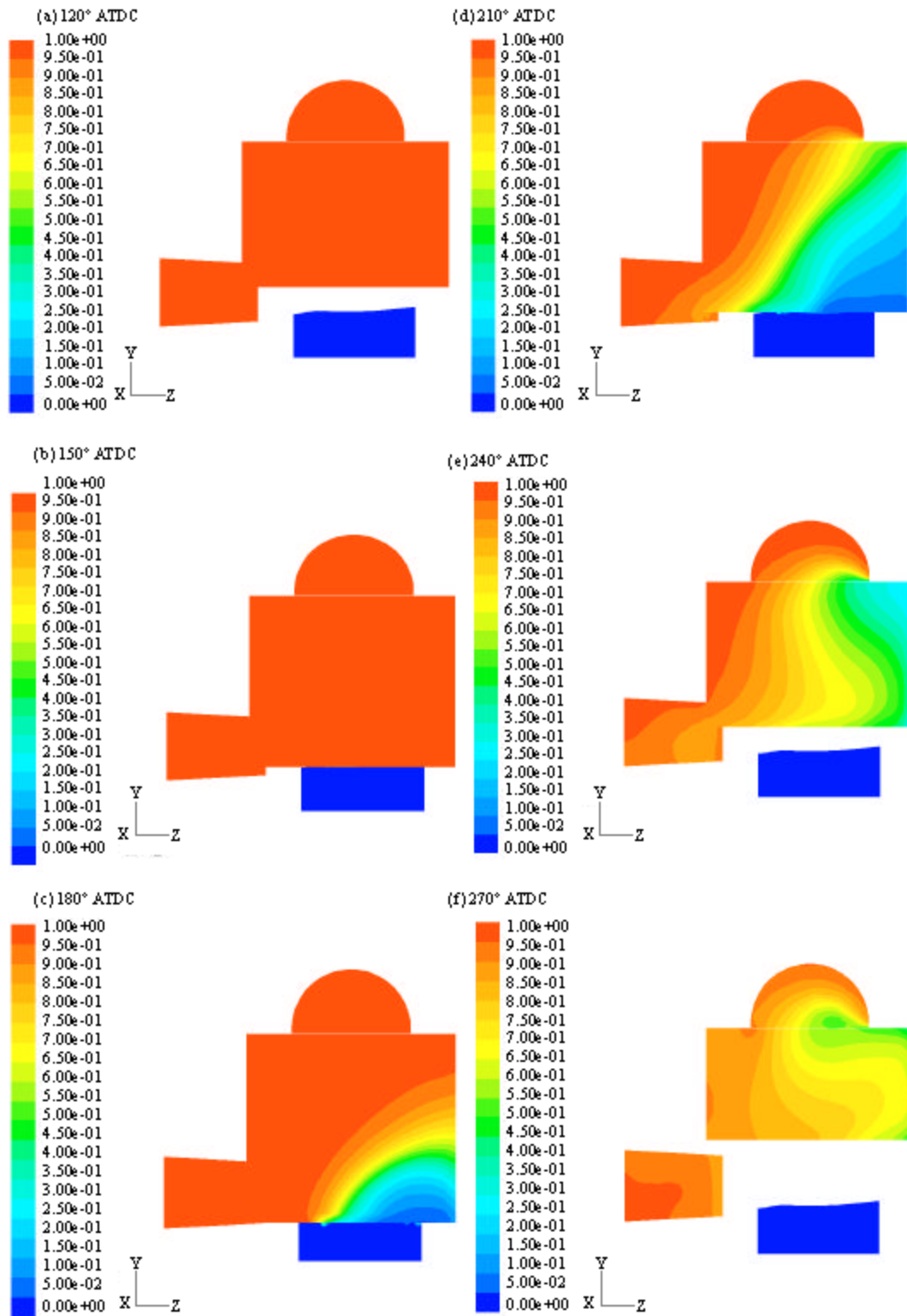

Fig. 14: Temporal change of gas species concentration at 1700 rpm

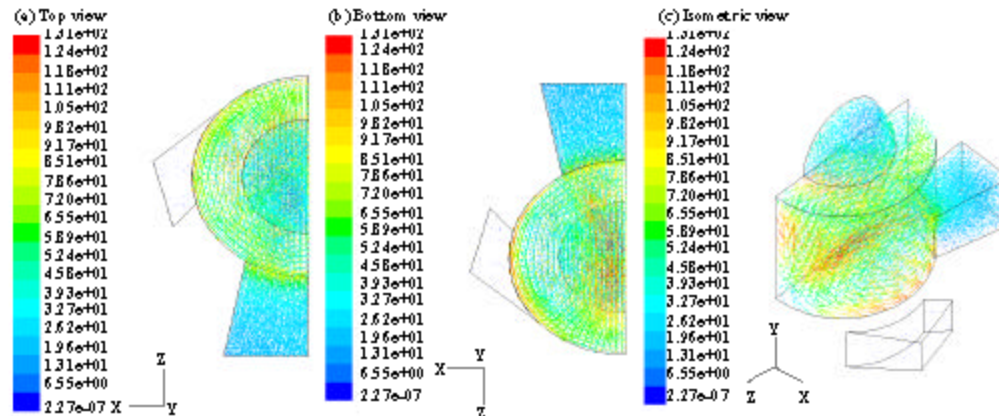

Fig. 15: Velocity field at different of plane

intake port. Figure 9 shows the characteristics of mass fraction of burned gases for intake port. The characteristics of mass fraction on intake port started happen when Intake Port started Open (IPO). The mass fraction of burned gases showed the amount of mass fraction very small value. The profile on Fig. 9 and 10 shows the symmetry condition which is the total amount of mass fraction between burned gases and fresh charge equal 1. When the piston on BDC, the characteristic of mass fraction is clearly seen while the piston on BDC.

Figure 10 shows the characteristics of mass fraction of fresh charge with the crank angle. Before Intake Port Open (IPO), the amount of mass fraction of fresh charge are constant and found the maximum value for all of engine speed. When intake port open IPO, the fresh charge entering the cylinder and produced the higher values while piston at BDC. It can be concluded that when IPC, all fresh charge trapped in the intake port and there is no entering flow occur to cylinder.

Several methods have been developed for determined what occurs in actual cylinder scavenging process (Heywood, 1988). Accurate measurement of scavenging efficiency is difficult due to the problem of measurement the trapping air mass. CFD prediction has proved useful in providing a qualitative picture of the scavenging flow field and identifying problems such as short-circuiting. Contours of mass fraction studies indicate the key features of the scavenging process. Figure 11 shows a different view of mass fraction characteristic. Based on this view, the detail figures for burned gases is displayed on x-z plane shown on Fig. 12 and 13 for different of engine speed. All detail results at Fig. 7-10 can be visualized clearly for several crank angles Figure 12-14 are displays from center of cylinder on symmetry plane. The characteristics of mass fraction can be understood when

the movement of piston started from Top Dead Centre (TDC) to Bottom Dead Centre (BDC). It can be concluded that the trend is the higher speed of engine give the slower mass fraction process to push all burned gases in cylinder to exhaust port due to of fresh charge entering through intake port.

Vectors results explained the scavenging flow happen in cylinder at the difference of crank angle and engine speed. Generally that the high velocity of tumble occurs at the exhaust port area when exhaust started trapped. As generally, the high tumble in cylinder area is responsible for the fast burn rate in the produced the high power stroke engines and can be influenced the engine performance. Most of tumble movement clearly display on volume clearance area. Figure 15 shows a different view of velocity vectors characteristic. The burned gases from exhaust port entering the cylinder. The backflow characteristic can be seen detailed on Fig 2-4. In these point view, it is found that at the high speed of velocity magnitude give the lower of pressure value.

CONCLUSION

The transient analysis of dynamic mesh was successfully investigated with CFD code. The concept predicted of the CFD model validation has been defined in this thesis. The CFD model is used for the flow analysis the three dimensional, unsteady conditions. The operating and boundary condition measured experimentally with the lower and higher pressure sensors to measure pressure on scavenging process. This research is significantly important to understand the design and characteristics on scavenging process, short-circuiting on cylinder and exhaust port.

ACKNOWLEDGEMENT

We would like to express our great acknowledge to University Malaysia Pahang for providing the funding GRS070121 and GRS070122 and the facilities to support of this research project.

REFERENCES

- Ahmadi-Befruji, B., W. Branstatter and H. Kratochwill, 1989. Multidimensional Calculation of the Flow Processes in Loop-Scavenged Two-Stroke Engine, SAE 890841.
- Amsden, A.A., P.J. O'Rourke and T.D. Butler, 1992. Comparison of Computed and Measured three-dimensional Velocity Fields in a Motored Two-Stroke Engine, SAE Paper 920418.
- Bakshi, S., D. Deshmukh and R.V. Ravikrishna, 2004. Multidimensional modeling of flow through piston-controlled ports using a multi-block, moving mesh algorithm. Proc. Instn. Mech. Engrs Part C: J. Mechanical Engineering Science, Vol. 218.
- Behrouz, C. and S. David, 1995. Intake-Port Behavior in a Motored and Fired Two-Stroke Research Engin. Exp. Thermal and Fluid Sci., 10: 86-100.
- Elligott, S.M., R. Douglas and R.G. Kenny, 1999. An Assessment of a Stratified Scavenging Process Applied to a Loop Scavenged Two-Stroke Engine, SAE 1999-01-3272/JSAE 9938027.
- Fadzil, A.R., A.L. Zulkifli and A. Azhar, 2004. Numerical Analysis of Scavenging and Combustion Process in Prototype Two Stroke Stepped-Piston Gasoline Engine. The Joint International Conference on Sustainable Energy and Environment (SEE).
- Fluent, 6.0, 2001. Dynamic Mesh Manual, Fluent. Inc, Cavendish Court, Lebanon.
- Franz, J.L., M. Gerhard and G. Simon, 1998. CFD Application in Compact Engine Development. SAE 982016.
- Gosman, A.D., 1985. Flow in a Model Engine with Shrouded Valve a Combined Experimental and Computational Study. SAE 850498.
- Heywood, J.B., 1988. Internal Combustion Engine Fundamental. New York, McGraw-Hill.
- Hori, H., T. Ogawa and T. Kuriyama, 1995. CFD In-Cylinder Flow Simulation of an Flow Visualization. SAE 950288.
- Hori, H., 2000. Scavenging Flow Optimization of Two-Stroke Diesel Engine by use of CFD. SAE 2000-01-0903.
- Kang, Y.H., K.K. Ku, R.C. Chang, C.P. Soo, M. Sun and Y.L. Kwi, 1993. Scavenging Flow Simulation of a Four-Poppet-Valved Two-Stroke Engine, SAE 930500.
- Laurine, J.L., S.S. Gary, L.G. Vladimir, S. Subrata, M.B. Adreas and M. Juergen, 1994. CFD Investigation of the Scavenging Process in a Two-Stroke Engine, SAE 941929.
- Liu, Q. and Z. Gao, 1996. Two-Dimensional Calculation of the Gas Exchange in Direct-injection Two-Stroke Engines, SAE 961805.
- Mugele, M., J. Tribulowski, H. Peters and U. Spicher, 2001. Numerical Analysis of Gas Exchange and Combustion Process in a small Two-Stroke Gasoline Engine, SAE 2001-01-3602.
- Raghnathan, R.D. and R.G. Kenny, 1997. CFD Simulation and Validation of the Flow within a Motored Two-Stroke Engine, SAE 970359.
- Spalding, D.B., 1981. A General Purpose Computer Program for Multi-Dimensional One and Two-Phase Flow. Math. Comput. Simulation, 23: 267-276.
- Tulus, K.A. Ahmad, A. Shahrir and M. Norhamidi, 2006. Simulation of In-Cylinder Pressures and Temperatures in the Combustion Chamber of Two-Stroke Linear Engine. 1st Regional Conference Vehicle Engineering and Technology, Kuala Lumpur.
- Wolfgang, Z., R. Heiko, R. Michael and K. Axel, 2000. Analysis of a Stratified Charging Concept for high-Performance Two-Stroke Engines., SAE 2000-01-0900.
- Yasou, M., M. Kazuhiro and M. Koji, 1999. Numerical Analysis of Gas Exchange Process in a Small Two-Stroke Gasoline Engine, SAE 1999-01-3330.