

## Performance Evaluation of Stable Energy Efficient Node Disjoint Ad-Hoc Routing Protocol

<sup>1</sup>V. Seethalakshmi and <sup>2</sup>G. Mohankumar  
<sup>1</sup>Sri Shakthi Institute of Engineering and Technology,  
Chinniampalayam, 641062 Coimbatore, India  
<sup>2</sup>Park College of Engineering and Technology,  
Kaniyur, 641059 Coimbatore, India

---

**Abstract:** A Mobile Ad-hoc Network (MANET) is a self-configuring infra-structure less network of mobile devices connected by wireless. Each device in a MANET is free to move independently in any direction and will therefore, change its links to other devices frequently. The nodes in the MANET are typically powered by batteries which have limited energy reservoir. Sometimes, it becomes very difficult to recharge or replace the battery of nodes, in such situation energy conservations are essential. Also, nodes move away without giving any notice to its cooperative nodes, causing changes in network topology and thus, these changes may significantly degrade the performance of a routing protocol. Hence, the energy consumption and lifetime of the node and link becomes an important issue in MANET. A technique is developed to make these protocols stable, energy-aware and node disjoint in order to increase the operational lifetime of an ad-hoc network. This technique uses a new routing cost metric which is a function of the remaining battery level in each node on a route. Also, it selects the least dynamic route with the longest lifetime for persistent data forwarding. Simulation results using AOMDV protocol show that combination of these techniques, the proposed protocol energy-AOMDV results in a significant improvement of the energy budget of the network and link stability as a whole resulting in increased operational life time.

**Key words:** Ad-hoc, AOMDV, RREQ, RREP, TORA, MANET, DSDV, DSR, MTPR, MBCR, MMBCR, CMBCR, battery, node

---

### INTRODUCTION

MANET is a wireless infrastructure less network having mobile nodes. Communication between these nodes can be achieved using multi hop wireless links. Each node will act as a router and forward data packets to other nodes. Since, the nodes are independent to move in any direction, there may be frequent link breakage. Ad-hoc networking is becoming very popular in this last years and the energy consumption issues and the link stability properties can be considered two important metrics to be accounted in the routing schemes. In the majority of the published study, the attention is focused on only one of the two aforementioned aspects. In this study, a new metric that allows optimizing these two criteria is proposed.

One of the most popular method to distinguish mobile ad-hoc network routing protocols is based on how routing information is acquired and maintained by mobile nodes. Using this method, mobile ad-hoc network

routing protocols can be divided into proactive routing, reactive routing and hybrid routing (Liu and Kaiser, 2005).

A proactive routing protocol is also called table driven routing protocol. Using a proactive routing protocol, nodes in a mobile ad-hoc network continuously evaluate routes to all reachable nodes and attempt to maintain consistent, up-to-date routing information. Therefore, a source node can get a routing path immediately if it needs one. The Destination-Sequenced Distance Vector (DSDV), Distance Routing Effect Algorithm for Mobility (DREAM), Wireless Routing Protocol (WRP), Fisheye State Routing (FSR) and Optimized Link State Routing Protocol (OLSR) are examples for reactive proactive protocols for mobile ad-hoc networks.

Reactive routing protocols for mobile ad-hoc networks are also called on-demand routing protocols. In a reactive routing protocol, routing paths are searched only when needed. A route discovery operation invokes a route-determination procedure. The discovery

procedure terminates either when a route has been found or no route available after examination for all route permutations. Compared to the proactive routing protocols for mobile ad-hoc networks, less control overhead is a distinct advantage of the reactive routing protocols. Thus, reactive routing protocols have better scalability than proactive routing protocols in mobile ad-hoc networks. However when using reactive routing protocols, source nodes may suffer from long delays for route searching before they can forward data packets. The Temporally Ordered Routing Algorithm (TORA), Dynamic Source Routing (DSR), Ad-hoc on Demand Routing (AODV), Ad-hoc on-demand Multipath Distance Vector Routing (AOMDV), Location Aided Routing (LAR), Associativity Based Routing (ABR) protocol, Signal Stability-based adaptive Routing (SSR) protocol are examples for reactive routing protocols for mobile ad-hoc networks

Hybrid routing protocols are proposed to combine the merits of both proactive and reactive routing protocols and overcome their shortcomings. Normally, hybrid routing protocols for mobile ad-hoc networks exploit hierarchical network architectures. Proper proactive routing approach and reactive routing approach are exploited in different hierarchical levels, respectively. The examples of hybrid routing protocols for mobile ad-hoc networks are the Zone Routing Protocol (ZRP), Zone-based Hierarchical Link State routing (ZHLS) and Hybrid Ad-hoc Routing Protocol (HARP).

The main objective of this study is to analyze AOMDV protocol for ways it could be improved. This can be done by measuring energy with respect to network size and taking into consideration the remaining battery power and link stability. This study also proposes a new routing algorithm energy-AOMDV based on node residual energy and received signal strength and it is applied on AOMDV so that the new algorithm provides better performance than existing energy algorithms like MTPR, MMBCR and CMMBCR.

## **MATERIALS AND METHODS**

**Energy aware routing protocols:** A number of routing proposals for ad-hoc networks took energy conservation into consideration so as to extend the lifetime of the wireless nodes by wisely using their battery capacity (Nayak *et al.*, 2012; Scott and Bambos, 1996; Singh *et al.*, 1998). Nayak *et al.* (2012) uses transmission power control techniques to reduce the power at nodes. In Scott and Bambos (1996), Minimum Total Power Routing (MTPR) is proposed. On the downside, this approach will in most cases tend to select routes with more hops than others. This is realizable due to the fact that transmission power is inversely proportional to

distance (Scott and Bambos, 1996). Thus, more energy may be wasted network-wide, since a larger number of nodes are now involved in routing as all nodes that are neighbors to the intermediate nodes will also be affected, unless they were in sleep mode. Minimum Battery Cost Routing (MBCR) (Singh *et al.*, 1998) utilizes the sum of the inverse of the battery capacity for all intermediate nodes as the metric upon which the route is picked. However, since it is the summation that must be minimal, some hosts may be overused because a route containing nodes with little remaining battery capacity may still be selected. Min-Max Battery Cost Routing (MMBCR) (Cano and Kim, 2002) treats nodes more fairly from the standpoint of their remaining battery capacity. Smaller remaining battery capacity nodes are avoided and ones with larger battery capacity are favored when choosing a route. However, more overall energy will be consumed throughout the network, since minimum total transmission power routes are no longer favored. As Toh (2001), MTPR is used when all the nodes forming a path (note that one path is sufficient) have remaining battery capacity that is above a so-called battery protection threshold and MMBCR is used if no such path exists. The combined protocol is called Conditional Max-Min Battery Capacity Routing (CMMBCR). In addition, the expected energy spent in reliably forwarding a packet over a specific link is considered by Misra and Banerjee (2002). In order to maximize the network life time, the cost function defined by Chang and Tassiulas (2000) takes into account energy expenditure for one packet transmission and available battery capacity. Furthermore, the queue load condition and the estimated energy spent to transmit all packets in the queue are considered (Kumar and Chockalingam, 2002). The study of various battery discharging property and possible applications are presented by Chiasserini *et al.* (2002). However, all of them ignored the mobility of mobile hosts and thus, it seems that they are more suitable for static networks.

**Link stability based routing protocols:** The LLT routing algorithms are used to estimate the lifetime of wireless links between every two adjacent nodes and then to select an optimal path. In the associatively-based routing algorithm (Toh, 1997), a link is considered to be stable when its lifetime exceeds a specific threshold that depends on the relative speed of mobile hosts. In the Signal Stability-based Adaptive (SSA) routing (Dube *et al.*, 1997), each link is classified as a strong one or a weak one, depending on the received signal strength measured when a node receives data packets from the corresponding upstream node. A mobile node only processes a Route Request (RREQ) that is received from a strong link. Tickoo *et al.* (2003) computed the fragility of

a link as the difference of the received signal strengths of consecutive packets flowing from the same origin to check if these two nodes are getting closer or moving apart. Gerharz *et al.* (2002) predicted the lifetime of a link between two adjacent mobile hosts through online statistical analysis of the observed links. Several studies attempted to predict the expiration time of the links by estimating the mobility of nodes (Qin and Kunz, 2002; Su *et al.*, 2001; Samar and Wicker, 2004). Note that all of these studies assumed for simplicity that mobile hosts are kept at a constant speed and direction in a short period. Samar and Wicker (2004) developed an analytical framework to investigate the behavior of nodes in a random mobility environment and derived analytical expressions that are related to the lifetime of links. As a different approach, Wu *et al.* (2006) used a two state Markovian model to reflect the mobility of nodes and evaluate the link dynamics. In MANETs, a route consists of multiple links in series and thus, its lifetime depends on the lifetime of each node, as well as the wireless links between adjacent nodes.

**Energy aware and link stability based routing protocols:**

Zhang *et al.* (2010) combined energy and node and Link Life Time (LLT) in route lifetime-prediction algorithm which explores the dynamic nature of mobile nodes (i.e., the energy drain rate of nodes and the relative mobility estimation rate at which adjacent nodes move apart) in a route-discovery period that predicts the lifetime of routes discovered and the longest lifetime route is selected for persistent data forwarding when making a route decision. De Rango *et al.* (2012) proposed a Link stability and Energy Aware Routing protocol (LEAR) protocol in which the next hop towards destination is the neighbor node that maximize (minimize) the joint link-stability-energy metric. The energy needed to send a packet is calculated while ignoring the energy spent for overhearing a packet. Power dissipation is calculated in terms of both power consumption at transmitter and receiver. For any node *i*, its non destination neighboring node *j* is selected as a node that has enough energy to receive the information sent from node *i* and which is also capable of transmitting the information to another relay node. For any node, the energy to transmit the packet should be lower or equal to the residual energy. Minimum drain rate along with drain rate index and residual energy is considered for measuring the energy dissipation rate of a given node. Link Stability and Energy Aware (LSEA) for efficient routing in mobile ad-hoc network (Hamad *et al.*, 2011) proposed a new routing protocol called Link Stability and Energy Aware (LSEA) is proposed which is

a modified version of ad-hoc on demand Distance Vector (AODV) protocol. LSEA utilize a novel route discovery process that takes into account the links constancy and the nodes residual energy to perform data routing. This study focus in showing how to look up the route discovery process whenever a source node attempts to communicate with another node for which it has no routing information. This uses random waypoint to model node mobility. The simulation results show that LSEA cut down the routing overhead by 17% and increases the network life time by 20% as compared to the traditional AODV. Park and Lee (2008) propose EBL in which the researchers give importance to both link stability and the residual battery capacity. The EBL not only improve the energy efficiency but also reduce network partition.

The aim of this contribution is the proposal of a novel routing protocol able to account for a joint metric of link stability and minimum energy drain rate in Mobile Ad-hoc Network (MANET).

**Proposed algorithm (energy-AOMDV):** The main aim of proposed routing is to selects the optimal paths using power aware metric and optimizes the power consumption, overhead and bandwidth.

**Multipath node-disjoint model:** This model describes the probability estimation of node disjoint paths between source and destination in a network. The 2 paths are said be node-disjoint if and only if there is no common intermediate node between them and source and destination nodes are common to both (Fig. 1). Let,  $P_j$  be the path from the source node *s* to destination node *d* via intermediate nodes  $n_1, \dots, n_k$  at time *t*, it is denoted by  $P_j = s-n_1-n_2-\dots-n_{k-1}-n_k-d$ . Let, *X* be a set of all the intermediate nodes on path  $P_i$ , let *Y* be a set of all intermediate nodes on path  $P_j$ , if  $P_i$  and  $P_j$  are said be node-disjoint if and only if  $X \cap Y = \Phi$  (Chiasserini *et al.*, 2002).

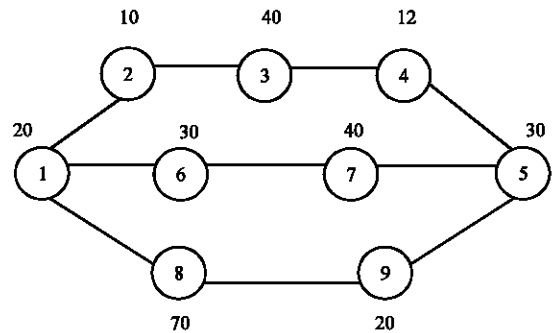

Fig. 1: Network with 9 nodes

**Energy aware routing model**

**Energy consumption:** According to IEEE specifications of the Network Interface Card (NIC) with 2 Mbps, the energy consumed to transmit a packet p is (Toh, 1997):

$$E(p) = i \cdot v \cdot tp \text{ Joules}$$

Were:

i = The current

v = The voltage

tp = The time taken to transmit the packet p

The energy required to transmit a packet p is given by  $E_{tx}(p) = 280 \text{ mA} \cdot v \cdot tp$ . The energy is required to receive a packet p is given by  $E_{rx}(p) = 240 \text{ mA} \cdot v \cdot tp$ . The energy consumption of overhearing the data transmission may be assumed as equivalent to energy consumption of receiving of the packet (Chiasserini *et al.*, 2002).

**Cost function and route selection:** The main objective of route selection is to select the optimal paths to prolong network's life time based on cost function. The main objective of cost function is to give more weight or cost to node with less energy to prolong its life time. Let,  $e_{it}$  be the battery capacity (residual energy) of a node  $n_i$  at time t. Let,  $fi(e_{it})$  be the battery cost function of node  $n_i$  at time t. The cost of node  $n_i$  is equal to value of battery cost function which in turn inversely proportional to residual energy of the node  $n_i$ , i.e.:

$$\frac{fi(e_{it}) \alpha 1}{e_{it}} \tag{1}$$

$$fi(e_{it}) = \rho_i \cdot x [Fi / e_{it}] \cdot x w_i \tag{2}$$

Where:

$fi(e_{it})$  = Cost of node  $n_i$  at time t

$\rho_i$  = Transmit power of node  $n_i$

$Fi$  = Full-charge capacity of node  $n_i$

$e_{it}$  = Residual energy (remaining battery capacity) of a node  $n_i$  at time t

$w_i$  = Weight factor which depends upon various factors, like battery's quality, battery's capacity, life time, battery's back up and price

**Cost of the path:** Consider two different costs for the path. The first cost is chosen as maximum cost of any intermediate node on the path  $P_j$ , it is denoted by:

$$C_1(P_j) = \max \{fi(e_{it})\} \tag{3}$$

The second cost is sum of cost of all intermediate nodes on the path  $P_j$ , it is denoted by:

$$C_2(P_j) = \sum_{i=1}^k fi(e_{it}) \tag{4}$$

**Optimal path selection:** Let,  $\gamma$  be threshold (cut-off) energy of battery of a node and it is considered that this threshold energy of battery is equal for all the nodes irrespective of their battery capacities. Let, M be the set of node disjoint multipath that were found during route discovery from source s to destination d at time t then a feasible path is given by:

$$P_f = \min(C_1(P_j)) \quad \forall P_j \in M \tag{5}$$

Where, min is a function that selects least cost. Let, F be the set of all feasible paths based Eq. 5. An optimal path is the feasible path with least total cost, it denoted by:

$$P_0 = \min(C_2(P_j)) \quad \forall P_j \in F \tag{6}$$

For example in Fig. 1, there are three node disjoint multipath say P1-P3 from source node 1 to destination node 5 where, P1 = 1-2-3-4-5, P2 = 1-6-7-5 and P3 = 1-8-9-5. As per Eq. 3, their costs are  $C_1(P1) = 40$ ,  $C_1(P2) = 40$  and  $C_1(P3) = 70$ . According to Eq. 5, P1 and P2 are feasible paths. According to Eq. 4, the total costs of P1 and P2 are  $C_2(P1) = 10+40+12 = 62$ ,  $C_2(P2) = 30+40 = 70$ . According to Eq. 6, an optimal path is P1.

**Path stability model:** Route P is said to be broken if any one of the following cases occurs. First, any one of the nodes in the route dies because of limited battery energy. Second, any one of the connections is broken because the corresponding two adjacent nodes move out of each other's communication range. Thus, the lifetime of route P is expressed as the minimum value of the lifetime of both nodes and connections involved in route P. Thus, the lifetime  $T_p$  of route P can be expressed as:  $T_p = \min(TN_i, TC_i)$ .

**Node life time (TNi):** Node life time can be evaluated based on its current residual energy and its past activity. The term  $RE_i$  represents the current residual energy of node i and  $dr_i$  is the rate of energy depletion.  $RE_i$  can simply be obtained online from a battery management instrument and  $evi$  is the statistical value that is obtained from recent history. Every T, node i reads the instantaneous residual energy value  $Re_i^0, Re_i^{2T}, Re_i^{3T}, \dots, Re_i^{(n-1)T}, Re_i^{nT} \dots$  and the corresponding estimated energy drain rate  $dr_i$  is obtained as:

$$dr_i^n = \frac{\alpha (RE_i^{(n-1)T} - RE_i^{nT})}{T + (1 - \alpha) dr_i^{n-1}}$$

Where:

- $dr_i^n$  = The estimated energy drain rate in the nth period
- $dr_i^{n-1}$  = The estimated energy drain rate in the previous (n-1)th period
- $\alpha$  = The coefficient that reflects the relation between  $dr_i^n$  and  $dr_i^{n-1}$  and it is a constant value with a range of [0, 1]

At time  $t$ , researchers can obtain the estimated node lifetime as follows:

$$T_{Ni} = \frac{RE_i^{nT}}{dr_i^n}$$

**Connection life time (TCi):** The connection time TCi depends on the relative motion between Ni and Ni-1, the definition of link stability is provided in what follows:

**Definition 1:** A link between two nodes i and j with transmission range R is established at time instant  $t_1$  when the distance between both nodes is such that  $d(i, j) < R$ .

**Definition 2:** A link between two nodes i and j with transmission range R is broken at instant time t when the distance between both nodes verify the condition  $d(i, j) > R$ .

**Definition 3:** A link age a or connection lifetime between two nodes i and j is the duration  $a(i, j) = TCi = t - t_1$ .

**Path life time:** The intermediate nodes updates the PLT value in the common header of the RREP packet with a local Min (NLT or LLT) value, if  $Min(NLT \text{ or } LLT) < PLT$  before forwarding this RREP packet. When the RREP packet reaches the source node, the PLT becomes the minimum value of the estimated lifetime of all nodes and links through the route from the source node to the destination node. In the persistent data forwarding period, a source node tends to select the path with the longest lifetime (the path with the maximum PLT value) from multiple paths as a source route for data forwarding.

**Modifications of RREQ packets:** The Route Request (RREQ) packet and Route Reply (RREP) packet of the AOMDV is modified. The RREQ of the AOMDV is extended by adding with three extra fields, one is cost field and another is max-cost and third is remaining energy field is shown in Fig. 2. It contains destination id, sequence no, advertised hop count, next hop and last hop field, time out field.

**Destination:** This field have id of destination node.

**Sequence no:** Maintain routes only for the highest known destination sequence number. For each destination, it is restrict that multiple paths maintained by a node have the same destination sequence number. For the same destination sequence number is:

**Route advertisement rule:** Never advertise a route shorter than one already advertised.

**Route acceptance rule:** Never accept a route longer than one already advertised.

**Advertised hop count:** To maintain multiple paths for the same sequence number, AOMDV uses the notion of an advertised hop count. Every node maintains a variable called advertised hop count for each destination. This variable is set to the length of the longest available path for the destination at the time of first advertisement for a particular destination sequence number. The advertised hop count remains unchanged until the sequence number changes. Advertising the longest path length permits more number of alternate paths to be maintained.

**Next hop and last hop:** Here, the last hop of a path from a node P to a destination D refers to the node immediately preceding D on that path. For a single hop path, next hop is D and last hop is the node P itself. For a two hop path, the next hop is also the last hop.

If two paths from a node P to a destination D are link disjoint, then they must have unique next hops, as well as

Destination	Sequence no.	Advertised hop count	Route list					Max-cost	Cost
			Next-hop 1	Last-hop 1	Hop-count 1	Time-out 1	Residual energy 1		
			Next-hop 2	Last-hop 2	Hop-count 2	Time-out 2	Residual energy 2		
			.	.	.	.	.		
			.	.	.	.	.		
			Next-hop n	Last-hop n	Hop-count n	Time-out n	Residual energy n		

Fig. 2: Fields of RREQ packet

unique last hops. This implication provides us with a tool to determine whether two paths via two unique downstream neighbors are link disjoint.

**Time out:** It is used to limit the life time of packet, initially by default it contains zero.

**Residual energy:** Energy left out in that node.

**Max-cost field:** When packet passes through a node, if its cost is greater than max-cost of packet, then this field is updated by the node by copying its cost otherwise this field is not disturbed. Initially by default this field contains zero value.

**Cost field:** It carries the cumulative cost when packet passes through a node; its cost is added to this field. Initially by default this field contains zero value.

**Modifications at source node:** As in AODV when a traffic source needs a route to a destination, the source initiates a route discovery process by generating a RREQ. Since, the RREQ is flooded network-wide, a node may receive several copies of the same RREQ. All duplicate copies are examined in AODMV for potential alternate reverse paths but reverse paths are formed only using those copies that preserve loop-freedom and disjointness among the resulting set of paths to the source. But in the proposed algorithm, source node maintains energy aware node disjoint multipath to a destination and it chooses the optimal path to send the data.

When RREP packet reaches the source node, the PLT becomes the minimum value of the estimated lifetime of all nodes and links through the route from the source node to the destination node as described in Eq. 2. In the persistent data forwarding period, a source node tends to select the path with the longest lifetime (the path with the maximum PLT value) from multiple paths as a source route for data forwarding.

**Modifications at intermediate node:** When an intermediate node receives a RREQ packet, it starts a Timer (Tr) and keeps its cost as Min-Cost (Minimum Cost). If additional subsequent RREQs arrive from the same source with the same sequence number from different paths, then the cost of the newly arrived RREQ packet is compared with the min-cost. If the new packet has a lower cost, min-cost is changed to this new value and the new RREQ packet is forwarded. Otherwise, the new RREQ packet is dropped. Hence in this approach, many duplicate RREQs will be dropped if they arrive with higher cost than to recorded. This process is repeated until time out. After time out, later duplicate RREQ packets will be dropped, even though they have lower cost because to minimize the route discovery time.

In the proposed algorithm when an intermediate node receives a RREQ packet, the following cases only new duplicate RREQ will be forwarded until time out.

#### **Algorithm**

**Step 1:** It checks if the sequence number specified in the RREQ message is greater than the node's sequence number.

**Step 2:** If so it checks whether Energy rem in node ( $E_r$ ) > Energy threshold (Eth).

**Step 3:** In case  $E_r > Eth$ , the residual energy field in RREQ is updated with the nodes residual energy.

**Step 4:** Node starts a Timer ( $T_r$ ) and keeps its cost as Min-cost (Minimum Cost)

**Step 5:** The cost of the newly arrived RREQ packet is compared with the min-cost. If the new packet has a lower cost, min-cost is changed to this new value.

- If its cost is equal to cost of previous RREQ and its max-cost is less than to max-cost of previous RREQ
- If its cost is equal to cost of previous RREQ and its max-cost is equal to max-cost of previous RREQ and its hop is less to hop of previous RREQ then new RREQ packet is forwarded

**Step 6:** Otherwise, the new RREQ packet is dropped.

**Step 7:** Its cost is entered in the cost field and added to the value in the total cost field.

**Step 8:** For calculating node stability, a variable NLT which represents the node lifetime is added to represent the estimated lifetime of the node and it is updated by all the intermediate node as per 3.3.1. For the lifetime of a link  $C_i$ , there are two sample packets exchanged between nodes  $N_{i-1}$  and  $N_i$  (packet 1:  $N_{i-1}$  RREQ  $\rightarrow N_i$ , packet 2:  $N_{i-1}$  RREP  $\leftarrow N_i$ ) in the route-discovery phase and thus, researchers can estimate the LLT using the proposed algorithm presented in 3.3.2. To implement this, every intermediate node agent needs to maintain a data structure called RREQ-info table in its local memory. This structure includes the RREQ id, the forwarding RREQ time and the RREQ received signal strength.

**Modifications at destination node:** Finally, all multiple RREQ (Route Requests) packets will be reached to the destination then destination adds total cost to each route request, now each route request contains a path from source to destination. In the conventional on demand multipath routing protocols, the source node computes optimal path (s) from multiple paths that were supplied by

the destination in the route reply. But here researchers have introduced new concept, the computation of optimal paths is assigned to the destination instead of the source to reduce the overhead.

**Route discovery:** When a RREQ packet arrives at an intermediate node, it is scanned, if destination address of the RREQ is same as address of intermediate node, then the intermediate node acts as destination node to send route reply else if either TTL value of RREQ is reached to zero or address of intermediate node is already exists, then received RREQ will be dropped, otherwise its partial information is recorded into route request packet whose format is shown in Fig. 2. After recoding the partial information:

- The intermediate node broadcasts the RREQ by incrementing the value of hop field by one
- By updating the max-cost ie Its cost is assigned to max-cost field if its cost is greater than value of max-cost field otherwise max-cost field will not be disturbed
- Its cost is added to cost field
- Residual energy field is modified with its energy

**Route reply by destination node:** Let assume that  $m$  be the number of multiple paths from the source to the destination, among them, let  $n$  be the number of node-disjoint paths. Researchers chose  $n = 3$ ; only three node-disjoint paths are considered that are selected by the destination and they were named as primary (first) path, secondary (second) path and ternary (third) path.

The destination selects the optimal path, now optimal is considered as primary path. Then, it selects the secondary path which is an optimal path among  $m$  multiple paths excluding primary and it is node disjoint to primary path. Then, it selects the ternary path which is an optimal path among  $m$  multiple paths excluding primary path and secondary path and node disjoint to primary path and secondary path if possible. By constructing three route reply packets, three paths are returned to source through their respective backward paths. Each route reply carries the path along with its cost and residual energy.

**Route maintenance:** Route maintenance in the proposed algorithm is a simple extension to AOMDV route maintenance. It also uses RERR packets. A node generates or forwards a RERR for a destination when the last path to the destination breaks. AOMDV also includes an optimization to salvage packets forwarded over failed links by re-forwarding them over alternate paths. The timeout mechanism similarly extends from a single path to multiple paths (Dube *et al.*, 1997).

**Modifications of RREP packets:** Three new entries, i.e., Path Life Time (PLT), RREQ time and RREQ signal strength are added to the common header of an RREP packet. The PLT represents the predicted lifetime of the source route in this packet header and can be updated when RREP packets are forwarded from the destination node to the source node in the route-discovery phase. The RREQ time and the RREQ signal strength represent the RREQ-Info of the previous RREQ node.

**Protocol description:** The proposed algorithm consists of the following three phases: Route discovery, data forwarding and route maintenance:

- Source node initiates the route discovery process by broadcasting a Route Request (RREQ) packet
- When an intermediate node receives a RREQ packet, the algorithm 1 in 3.6 is checked
- For a path sequence  $S, \dots, Ni-1, Ni, Ni+1, \dots, D$  when an intermediate node  $Ni$  receives an RREQ packet from  $Ni-1$ , it adds this RREQ id, the current time and the received signal strength to its RREQ-Info table before it continues to forward this RREQ packet. Similarly, node  $Ni+1$  also save the RREQ-Info from node  $Ni$  in its local memory
- All multiple RREQ (Route Requests) packets will be reached to the destination and then destination adds total cost to each route request. The destination then selects feasible path and optimum path as per Eq. 5 and 6
- Destination selects  $n$  number of node disjoint and optimum paths and send RREP through paths
- In the returning RREP period when node  $Ni$  receives an RREP packet from node  $Ni+1$ , the RREQ-Info from  $Ni$  (information of  $Ni$  RREQ  $\dots \rightarrow Ni+1$ ) has been added to the RREP header by  $Ni+1$  before node  $Ni+1$  sends an RREP packet to node  $Ni$ . Simultaneously, node  $Ni$  knows the RREP time and the RREP received signal strength from node  $Ni+1$  (information of  $Ni$  RREP -  $\dots Ni+1$ ). Thus, it can obtain the second sample packet that is delivered between the corresponding two nodes ( $Ni, Ni+1$ ) and thus researchers can calculate the connection time  $TCi$  using the connection lifetime-prediction algorithm and then update the local LLT value
- The intermediate nodes updates the PLT value in the common header of the RREP packet with a local Min (NLT or LLT) value, if  $Min (NLT \text{ or } LLT) < PLT$ , before forwarding this RREP packet
- When this RREP packet reaches the source node, the PLT becomes the minimum. A source node tends to select the path with the longest lifetime (the path with the maximum PLT value) from multiple paths as a source route for data forwarding

**RESULTS AND DISCUSSION**

The simulation is carried out in NS2 under LINUX platform. In this study, various routing protocols related to energy like MTPR, MBCR, MMBCR, CMMBCR and energy-AOMDV are compared with respect to the performance parameters, such as energy consumption, packet delivery ratio, packet lost, end to end delay, overhead and throughput. Table 1 shows that the important parameters chosen for the NS2 simulation:

**Simulation parameters**

**Packet delivery ratio:** It is the ratio of the data packets delivered to the destinations to those generated by the sources.

**Energy consumption:** This is the ratio of the average energy consumed in each node to total energy.

**End to end delay:** This is the ratio of the interval between the first and second packet to total packet delivery.

**Throughput:** The throughput metric measures how well the network can constantly provide data to the sink. Throughput is the number of packet arriving at the sink per ms.

**Number of packets dropped:** This is the number of data packets that are not successfully sent to the destination during the transmission. In this study, the time versus number of packets dropped have been calculated.

**Routing overhead:** It is defined as the amount of routing control packets, including RREQ and RREP.

**Simulation results:** Figure 3 shows the comparison of throughput for various routing protocols using 50 nodes. It shows that the throughput is maximum for energy-AOMDV compared to other protocol.

Table 1: Simulation environment

Parameters	Values
Simulation time	100 sec
Topology size	1000×1500 m
No. of nodes	50
MAC type	MAC 802.11
Radio propagation model	Two ray model
Radio propagation range	250 m
Pause time	0 sec
Max speed	4-24 m sec <sup>-1</sup>
Initial energy	100 J
Transmit power	0.4 W
Receive power	0.3 W
Traffic type	CBR
CBR rate	512 bytes×6 sec <sup>-1</sup>

Figure 4 shows the comparison of packet delivery ratio for various routing protocols using 50 nodes. It shows that the packet delivery ratio is maximum for energy-AOMDV compared to other protocol.

Figure 5 shows the comparison of overhead for various routing protocols using 50 nodes. It shows that the overhead is minimum for energy-AOMDV compared to other protocol.

Figure 6 shows the comparison of energy consumption for various routing protocols using 50 nodes. It shows that the energy consumption is minimum for energy-AOMDV compared to other protocol.

Figure 7 shows the comparison of packet lost for various routing protocols using 50 nodes. It shows that the packet lost is minimum for energy-AOMDV compared to other protocol.

Figure 8 shows the comparison of end-to-end latency versus time for MTPR, MBCR, MMBCR, CMMBCR

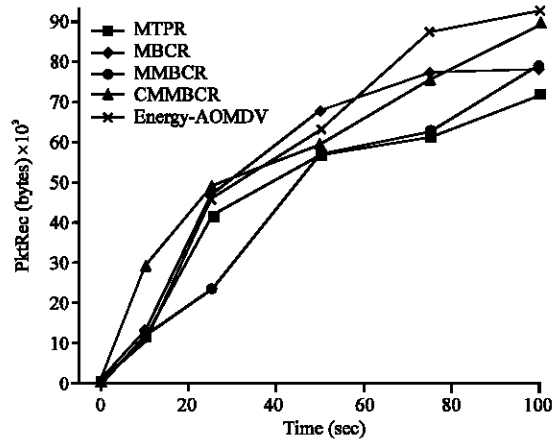

Fig. 3: Comparison of throughput for 50 nodes

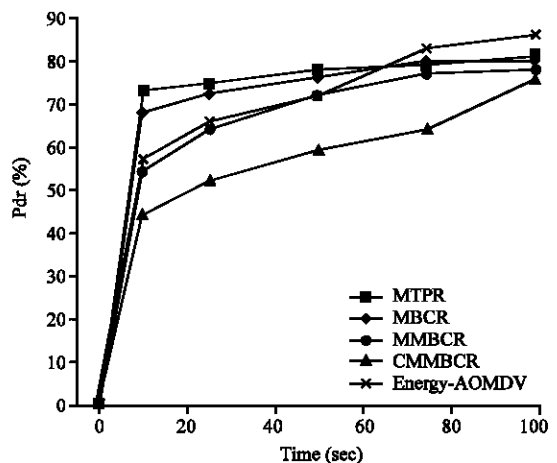

Fig. 4: Comparison of packet delivery ratio for 50 nodes



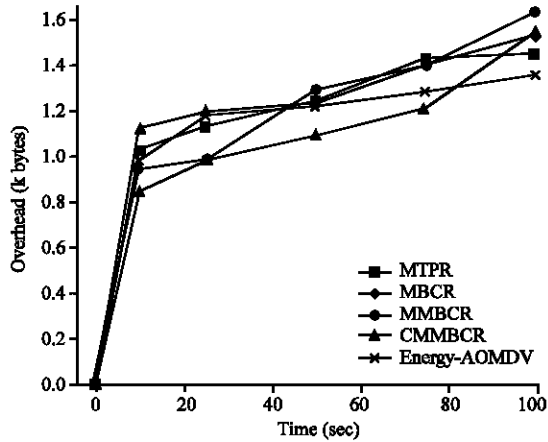

Fig. 5: Comparison of overhead for 50 nodes

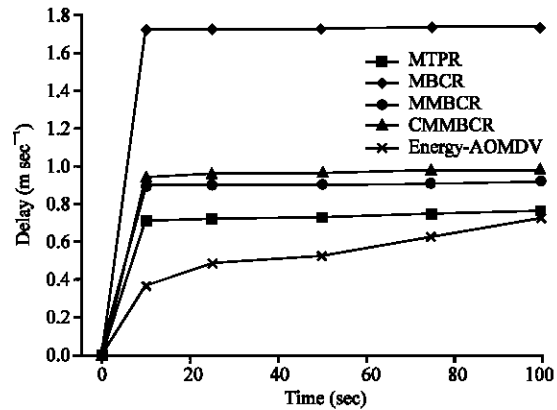

Fig. 8: Comparison of end-to-end latency vs. time using 50 nodes

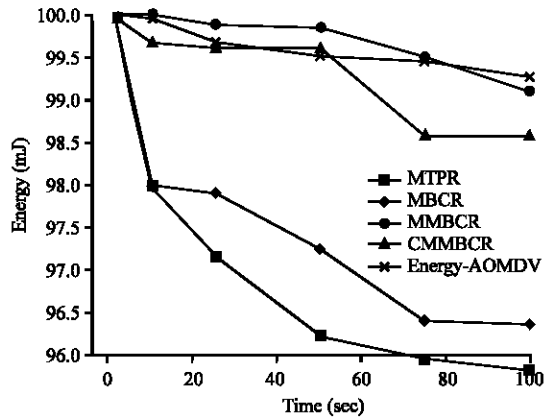

Fig. 6: Comparison of energy consumption for 50 nodes

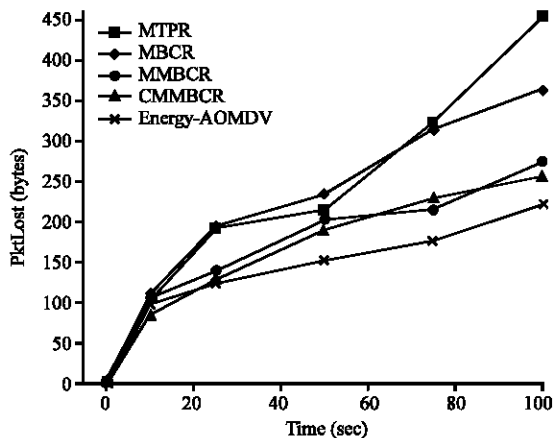

Fig. 7: Comparison of packet lost using 50 nodes

and energy-AOMDV protocols using 50 nodes. It shows that the end-to-end latency of network using energy-AOMDV is minimum compared to MTPR, MBCR, MMBCR and CMMBCR.

## CONCLUSION

In the proposed algorithm, source node initiates a timer and till it expires accept all the duplicate RREQ packet in order to not miss a path with maximum energy. This may increase flooding. This is compensated by making the destination node to take decision about optimal paths and send route reply only to the best 5 of these paths and hence significantly reduces the flooding. This result in an increased packet delivery ratio, decreasing end-to-end delays for the data packets, fewer collisions of packets, supporting reliability and decreasing power consumption. Each route request carries the cumulative cost and route reply carries PLT value so very little bit overhead is increased but it is negligible. It supports node-disjoint multiple paths for reliability and congestion control. It supports stability, i.e., it increases mean time to failure of the nodes by distributing the burden of routing. Computation of path lifetime is assigned to source node which selects best 3 paths out of 5 optimum paths.

## REFERENCES

- Cano, J.C. and D. Kim, 2002. Investigating performance of power aware routing protocols for mobile adhoc networks. Proceedings of the International Mobility and Wireless Access, October 12, 2002, Fort Worth, TX., USA., pp: 80-86.
- Chang, J.H. and L. Tassiulas, 2000. Energy conserving routing in wireless ad hoc networks. Proceedings of the 19th Annual Joint Conference of the IEEE Computer and Communications Societies, March 26-30, 2000, IEEE Computer Society Press, pp: 22-31.

- Chiasserini, C.F., P. Nuggehalli and V. Srinivasan, 2002. Energy-efficient communication protocols. Proceedings of the 39th Design Automation Post-Conference, June 10-14, 2002, New Orleans, Louisiana, pp: 824-829.
- De Rango, F., F. Guerriero and P. Fazio, 2012. Link-stability and energy aware routing protocol in distributed wireless networks. *IEEE Trans. Parallel Distrib. Syst.*, 23: 713-726.
- Dube, R., C.D. Rais, K.Y. Wang and S.K. Tripathi, 1997. Signal stability-based adaptive routing (SSA) for ad hoc mobile networks. *IEEE Personal Commun.*, 4: 36-45.
- Gerharz, M., C. de Waal, M. Frank and P. Martini, 2002. Link stability in mobile wireless ad hoc networks. Proceedings of the 27th Annual IEEE Conference on Local Computer Networks, November 6-8, 2002, Tampa, Florida, pp: 30-42.
- Hamad, S., H. Nouredine and H. Al-Raweshidy, 2011. LSEA: Link stability and energy aware for efficient routing in mobile ad hoc network. Proceedings of the 14th International Symposium on Wireless Personal Multimedia Communications, October 3-7, 2011, Brest, France, pp: 1-5.
- Kumar, K.K. and A. Chockalingam, 2002. Energy efficient routing in wireless ad-hoc. Proceedings of the National Conference on Communications, January 2002, Mumbai, India -.
- Liu, C. and J. Kaiser, 2005. A survey of mobile ad hoc network routing protocols. University of Ulm Technical Report Series No. 2003-08. [http://www.minema.di.fc.ul.pt/reports/report\\_routing-protocols-survey-final.pdf](http://www.minema.di.fc.ul.pt/reports/report_routing-protocols-survey-final.pdf).
- Misra, A. and S. Banerjee, 2002. MRPC: Maximizing network lifetime for reliable routing in wireless environments. Proceedings of the IEEE Wireless Communications and Networking Conference, March 17-21, 2002, Orlando, Florida, pp: 800-806.
- Nayak, P., R. Agarwal and S. Verma, 2012. Energy Aware AODV (EA-AODV) Using Variable Range Transmission. In: *Advances in Computer Science, Engineering and Applications*, Wyld, D.C., J. Zizka and D. Nagamalai (Eds.). Springer-Verlag, Berlin, Germany, pp: 589-597.
- Park, G.W. and S. Lee, 2008. A routing protocol for extent network lifetime through the residual battery and link stability in MANET. Proceedings of the Applied Computing Conference, May 27-30, 2008, Istanbul, Turkey, pp: 199-204.
- Qin, L. and T. Kunz, 2002. Pro-active route maintenance in DSR. *ACM SIGMOBILE Mobile Comput. Commun. Rev.*, 6: 79-89.
- Samar, P. and S.B. Wicker, 2004. On the behavior of communication links of a node in a multi-hop mobile environment. Proceedings of the International Symposium on Mobile Ad Hoc Networking and Computing, May 24-26, 2004, Roppongi, Japan, pp: 145-156.
- Scott, K. and N. Bambos, 1996. Routing and channel assignment for low power transmission in PCS. Proceedings of the 5th IEEE International Conference on Universal Personal Communications, Volume 2, September 29-October 2, 1996, Cambridge, MA., USA., pp: 498-502.
- Singh, S., M. Woo and C. Raghavendra, 1998. Power-aware routing in mobile ad hoc networks. Proceedings of the 4th Annual ACM/IEEE International Conference on Mobile computing and Networking, October 25-30, 1998, Dallas, TX., USA., pp: 181-190.
- Su, W., S.J. Lee and M. Gerla, 2001. Mobility prediction and routing in *ad hoc* wireless networks. *Int. J. Network Manage.*, 11: 3-30.
- Tickoo, O., S. Raghunath and S. Kalyanaraman, 2003. Route fragility: A novel metric for route selection in mobile ad hoc networks. Proceedings of the 11th IEEE International Conference on Networks, September 28-October 1, 2003, Sydney, Australia, pp: 537-542.
- Toh, C.K., 1997. Associativity-based routing for ad hoc mobile networks. *Wireless Personal Commun.*, 4: 103-139.
- Toh, C.K., 2001. Maximum battery life routing to support ubiquitous mobile computing in wireless ad hoc networks. *IEEE Commun. Mag.*, 39: 138-147.
- Wu, X., H.R. Sadjadpour and J.J. Garcia-Luna-Aceves, 2006. An analytical framework for the characterization of link dynamics in MANETs. Proceedings of the IEEE Military Communications Conference, October 23-25, 2006, Washington, DC., USA., pp: 1-7.
- Zhang, X.M., F.F. Zou, E.B. Wang and D.K. Sung, 2010. Exploring the dynamic nature of mobile nodes for predicting route lifetime in mobile Ad Hoc networks. *IEEE Trans. Veh. Technol.*, 59: 1567-1572.