

Modeling of Heat and Power System Optimal Structure Using Software

¹L.V. Plotnikova, ¹L.A. Kashipova and ²R.A. Ishmuratov

¹FSBEI HE “Kazan State Power Engineering University”, Krasnoselskaya Str., 51, Kazan, Russia

²FSBEI HE “Kazan Federal University”, Kremlevskaya Str., 18, Kazan, Russia

Abstract: The problem of energy efficiency for heat and power energy generating systems and industrial objects which have a complex structure with feedbacks; the solution is proposed in the form of a system optimal structure development using the developed software package.

Key words: Heat and power system, feedback, optimal structure, computer simulation, LabVIEW, system approach, thermodynamic parameters

INTRODUCTION

One of the major problems of mankind is that it saves energy resources. Due to the intensification of competition between the companies producing power equipment as well as the consideration of a socio-economic situation complexity, the relevance of saving objectives and the rational use of energy resources increases every year. The problem of energy-saving system optimal structure at power generation and industrial facilities occupies an important place in the category of scientific research organizations, design and industrial firms all over the world (Shelginsky, 2010; Nazmeev and Konahina, 2001; Pleshivtseva and Afinogentov, 2008). The largest consumers of energy resources are represented by energy and industrial facilities, chemical, petrochemical, food processing, pulp and paper industries. These facilities are characterized by considerable energy losses, in particular in the form of so-called secondary energy resources. Consequently, the organization of optimal structures of enterprises and energy facilities is important taking into account the possibility of additional energy production from the secondary energy.

The heat power system of the listed above objects represent a complex associations, consisting of a variety of interdependent units, differing in purpose, design, a process line incorporation structure, taking into account the interactions with the energy systems. All system devices are interconnected by links, each of which carries out the information about pressure, temperature, enthalpy and material consumption; This information is either the result of measurement at an enterprise, or the result of calculations. Many links are reversed on large objects, that is they are sent to one of the previous elements. That is the operation of each circuit unit can make the influence

on the operation of a previous unit as well as on the power consumption graphics and the output of secondary resources in the production line, in which this relationship included (Nazmeev and Konahina, 2001; Pleshivtseva and Afinogentov, 2008). Thus, the process of such system calculation with feedback may have numerous or even infinite iterations. Hence, an important task is the choice of methods and the means of complex structured heat and power system calculation using the results of stream parameter measurements that are the links in such systems. The solution of this problem will allow to find an optimal structure of an energetic facility or an industrial enterprise energy system.

MATERIALS AND METHODS

Labview software use for optimal structure of heat and power system modelling: The calculation of complex heat and power systems can use a variety of the environments for mathematical modeling, the algorithmic and other software (Pleshivtseva and Afinogentov, 2008; Smirnov and Galashev, 2012). One of the tools for the iterative calculations of complex heat and power systems was the graphic software LabVIEW (Laboratory Virtual Instrument Engineering Workbench).

LabVIEW package was chosen as the means which allows to measure the parameters of thermal power system operation in order to perform visual thermodynamic calculations. It allows you to show a system structure and to carry out the calculation of each system element parameter. Even if there are lots of feedback and a large number of iterations LabVIEW allows you to make a quick calculation of the system. Consequently, LabVIEW was selected as the tool for the thermodynamic calculation of complex structured industrial systems.

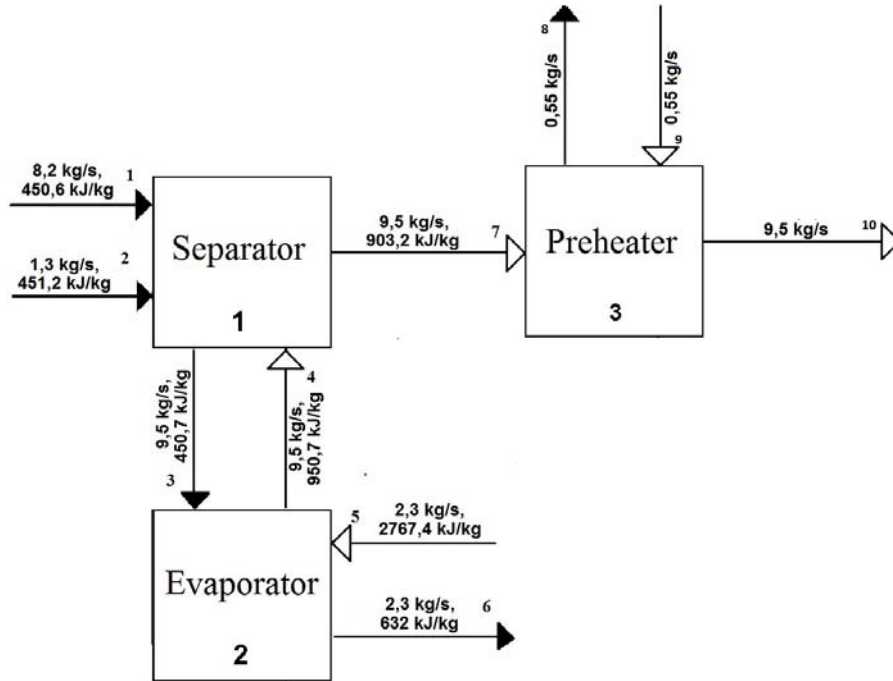

Fig. 1: Heat and power system area; 1: separator; 2: evaporator; 3: heater

Let's consider the sequence of operations at the implementation of the thermodynamic analysis using LabVIEW language and the example of a heating system area preparation for pyrolysis on the basis of petrochemical production, as it is the initial stage of the technological process and is especially important to perform the correct calculations and not to allow an inefficient use of raw materials. The process of industrial pyrolysis is a complex one, its heat power system includes a large number of elements and feedbacks. For a more visual representation of a complex system calculation with the necessary iterations let's consider its site (Fig. 1) represented by heat exchange equipment an evaporator and a hydrocarbon heater.

The consumables and the thermodynamic parameters of the flows are determined according to SCADA mode charts and process regulations. The features of flows are shown on Fig. 1. Propane-butane fraction (stream 1) with the maximum pressure of 2 MPa is supplied to the separator 1, from which it enters in the evaporator 2 tube space (stream 3) and is evaporated due to the water steam condensation heat supplied into the intertubular area of evaporators. The acceptance of ethane fraction raw material (stream 2) is provisioned. The raw material evaporates (stream 4) in the evaporators 2 due to the water vapor condensation heat supplied from the steam collector of 0.6 MPa (stream 5). The gaseous raw material (stream 7) passes the separator 1 and enters the preheater

3, where it is heated up to the temperature of 60°C by the pressure steam of 0.6 MPa (stream 9). The gaseous raw material enters to the raw collector of pyrolysis furnaces (stream 10) after the heater 3.

According to the described above sequence of processes within the considered area, the area calculation sequence is the following one:

- Knowing the temperature and the pressure of the flow 3 (raw materials: propane-butane and ethane fraction), the enthalpy i_3 value is determined according to reference data
- We obtain i_4 from the heat balance equation of the heat exchanger 2 (the enthalpy of the evaporated fractions), where G is matter consumption, η is efficiency, i is enthalpy:

$$i_4 = \frac{G_{56}(i_5 - i_6)\eta}{G_{34}} + i_3 \quad (1)$$

- We recalculate the liquid fraction enthalpy i_3 , exiting from the separator from the heat balance equation for the separator 1:

$$i_3 = \frac{G_1 i_1 + G_2 i_2 + G_4 i_4 - G_7 i_7}{G_3} \quad (2)$$

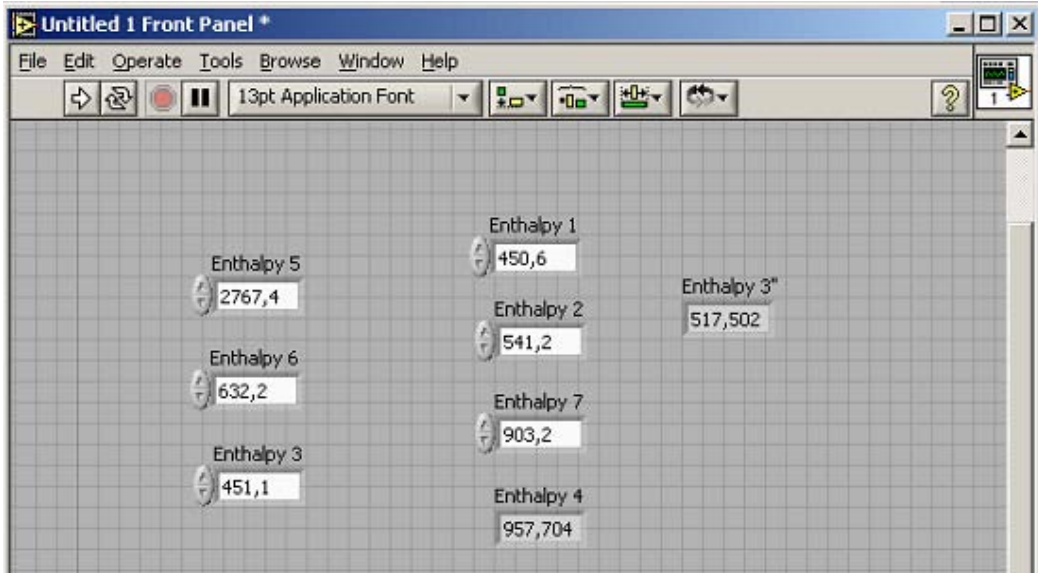

Fig. 2: Enthalpy calculation of the system portion streams with the use of LabVIEW

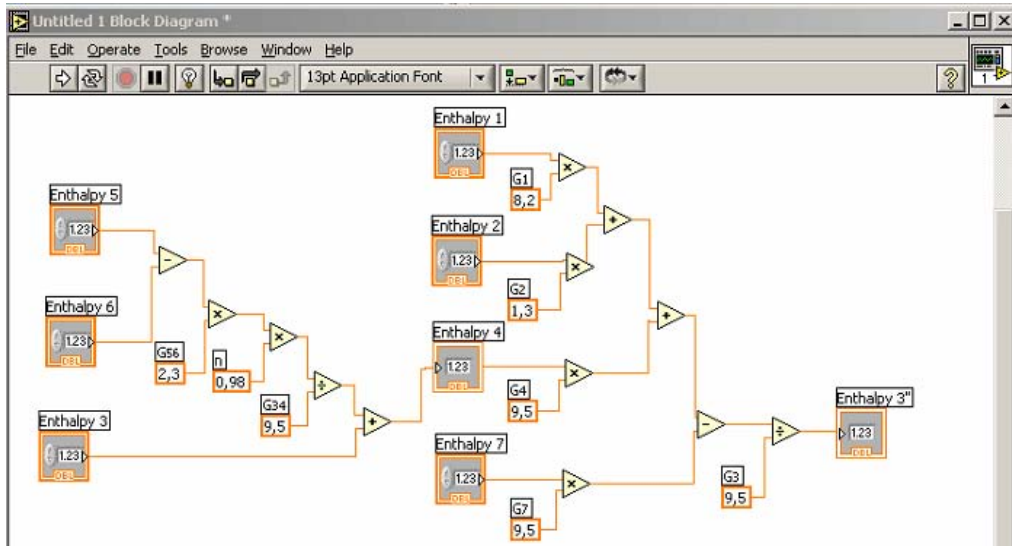

Fig. 3: Block diagram for the calculation of a system area flow specific heat using LabVIEW

The enthalpy (specific heat) of the system considered portion streams is shown on the LabVIEW front panel (Fig. 2).

The functional block diagram clearly showing the calculation of the specific flow heat for the considered system in accordance with Eq. 1 and 2 is shown in Fig. 3.

After the calculation performance (Fig. 2), we see that the value of the stream enthalpy $i_3 = 517.3 \text{ kJ kg}^{-1}$ does not coincide with the initially defined value $i_3 = 451.1 \text{ kJ kg}^{-1}$. Since, the streams 3 and 4 represent a

feedback system, we perform the second calculation using the obtained value of the stream 3 enthalpy $i_3 = 451.1 \text{ kJ kg}^{-1}$ which is shown on Fig. 4. However, after the second iteration, the enthalpy i_3 values did not become close to each other, the stream 3 enthalpy made $i_3 = 583.9 \text{ kJ kg}^{-1}$. It can be concluded that the number of iterations repeated until the moment when the recalculated values do not match, will be numerous and even infinite ones. Of course, the use of LabVIEW for such numerous calculations accelerates the process of parameter value

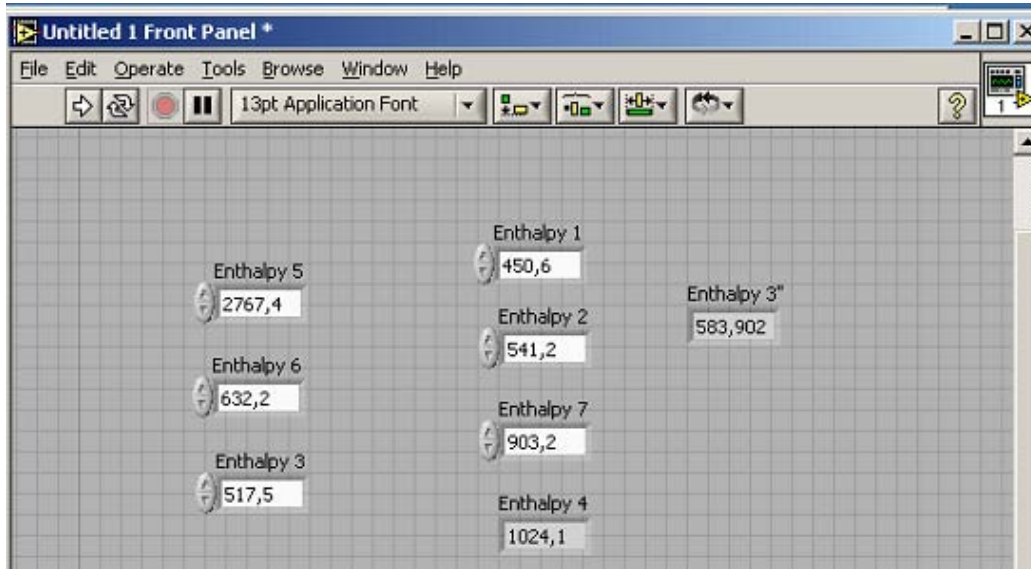

Fig. 4: Re-calculation of flow enthalpy for a production site using LabVIEW

determination for a power heating system but the time spent will be also too large at a significant number of iterations.

Thus, the use of LabVIEW confirmed the need for multiple iterations during thermodynamic calculations of complex heat and power systems.

So, using LabVIEW, you can visualize a system structure, specify the direction of flows, their values and make calculations. However, LabVIEW does not eliminate the need for the iterations in complex systems, in some cases the number of iterations may be infinite. Using this software package, we can not determine a unified sequence of a system calculation.

The advantage of LabVIEW during the solution of this problem is the visibility of calculation results and the speed of their preparation. LabVIEW can be used for heat and power calculations of heat and power systems with the measurement results as system stream parameters. However, the complex systems with a large amount of feedback should create other means for heat and power system analysis, which will relieve the system of backward linkages (Nazmeev and Konahina, 2001).

RESULTS AND DISCUSSION

Software implementation of systematic analysis procedure concerning complex heat and power systems:

In order to exclude multiple iterations in complex systems it is proposed to supplement the thermodynamic analysis by the structural analysis. Together with the thermodynamic analysis it provides one of the system

analysis variations (Popyrin, 1978). Structural analysis allows you to get rid of multi-loop structure and determine the optimum sequence for a system calculation. An initial system is simplified, the unclosed sequences of elements are calculated separately and the closed ones, i.e., contours are broken and are presented as non-closed ones. Thermodynamic analysis, based on the sequence defined in the structural analysis will allow to calculate a scheme and the thermodynamic potential of the streams that can be used effectively to improve a system energy efficiency.

During the performance of a power heating system structure analysis the method is used based on the analysis of adjacency matrices (Popyrin, 1978). An adjacency matrix is a square matrix, the number of rows and columns which are equal to the number of device elements in a system. The presence of values in a matrix cell means that there is the availability of a stream in a system, coming from an element specified by the line number into the element specified by a column number. The absence of a value is the absence of a flow.

So, for a well-known thermal power system, Fig. 5 considered by Popyrin (1978), the adjacency matrix will be as follows (Table 1).

Then, the search of all available system circuits is performed. In order to identify the contours the following rule is applied: the element (i, j) of two matrix product, A and B is $\sum_{k=1}^m a_{ik}b_{kj}$, where a_{ik} and b_{kj} are the elements of A and B matrix, respectively. They use Boolean arithmetic during the multiplication of matrices, that is: $0+0=0$;

Table 1: Adjacency matrix for a system

	1	2	3	4	5	6	7	8	9	10	11
1	-	1	-	-	-	-	-	-	-	-	-
2	-	-	2	-	-	-	-	-	-	-	-
3	-	-	-	3	5	-	-	-	-	-	-
4	-	4	-	-	-	-	-	-	-	-	-
5	-	-	-	-	-	6	8	-	-	-	-
6	7	-	-	-	-	-	-	-	-	-	-
7	-	-	-	-	-	-	-	9	-	-	-
8	-	-	-	-	-	-	-	-	10	-	-
9	-	-	-	-	-	-	-	-	-	11	-
10	-	-	-	-	-	-	-	-	-	-	12
11	-	-	-	-	-	-	-	-	13	-	-

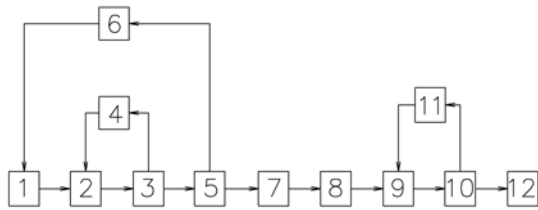

Fig. 5: The example of heat and power system structure

$0+1 = 1$; $1+1 = 1$; $0\cdot0 = 0$; $0\cdot1 = 0$; $1\cdot1 = 1$. Thus, the numerical values in an adjacency matrix are replaced by ones and their absence is replaced by zeros. Multiplied by itself k -times, according to the rules of Boolean algebra a condensed adjacency matrix shows the connections that go from any information block to any other information block through k streams, where $k = n-1$ and n is a matrix dimension. If there is a loop, then in some degree of multiplication the block will contact with itself (figure one will appear on a matrix diagonal).

This problem is difficult to solve manually, so the choice among software products and programming languages was performed for the software implementation of the structural analysis. The conclusions on the possibility of their use were made. The result of MathLab application possibilities study revealed that it is possible to multiply matrices, that is it is possible to carry out assessment of links in a system but it is impossible to identify the sequences of elements.

The programming language Visual Basic for Application (VBA) has built-in intelligence, it has a graphical interface and is easy to learn and this allows to work not only with matrices but with other mathematical entities. However, it is impossible to multiply large matrices in VBA. Tests showed that the VBA copes with the multiplication of matrices with the dimension $< 60 \times 60$ but the heat and power systems include > 100 elements as a rule.

Unlike VBA the programming language C # can handle a large amount of data. Besides, C # has an easily customized graphical interface which is important for

visual data input and the presentation of results. Thus, in order to implement the structural analysis the program was developed using C # language in Microsoft Visual Studio environment (Plotnikova *et al.*, 2010). The program allows to perform a user-friendly input of a matrix as a table, display each matrix multiplication; output the identified element sequence and to determine arbitrarily broken streams (Plotnikova *et al.*, 2015). The interface of the developed program developed is the following one (Fig. 6).

At the top of the software window a matrix dimension is determined according to the number of elements in a system. Below the input of stream values and numbers into matrix cells takes place originating from the elements specified by the numbers of rows into the elements specified by column numbers. Later, these values and numbers will be of use, as the specific thermodynamic and consumable characteristics of streams will correspond to a numeric value of a cell.

The results are displayed in the lower part of the program. An introduced matrix is converted into the Boolean form containing only ones and zeros. Then the results are given for each matrix multiplication, as shown on Fig. 7a. After some multiplications the element circuits are derived identified by this multiplication in the system, as follows from Fig. 7b and c.

Then, in order to represent a heat and power system in the form of an open sequence of elements, i.e., to determine a conditionally linear calculation sequence should be an open loop, i.e., to carry out the break of streams. In order to determine an optimal, i.e., the minimum number of streams, the conditional break of which will allow to perform the calculation of a technological scheme, the method is applied using a cycle matrix (Popyrin, 1978). The minimum number of broken streams can be obtained if we break a stream with maximum frequency and then the streams with minimum rate and maximum frequency.

The detected contours in the developed program are displayed at the bottom part of the result window (Fig. 7d). They also showed the broken flows. In this case

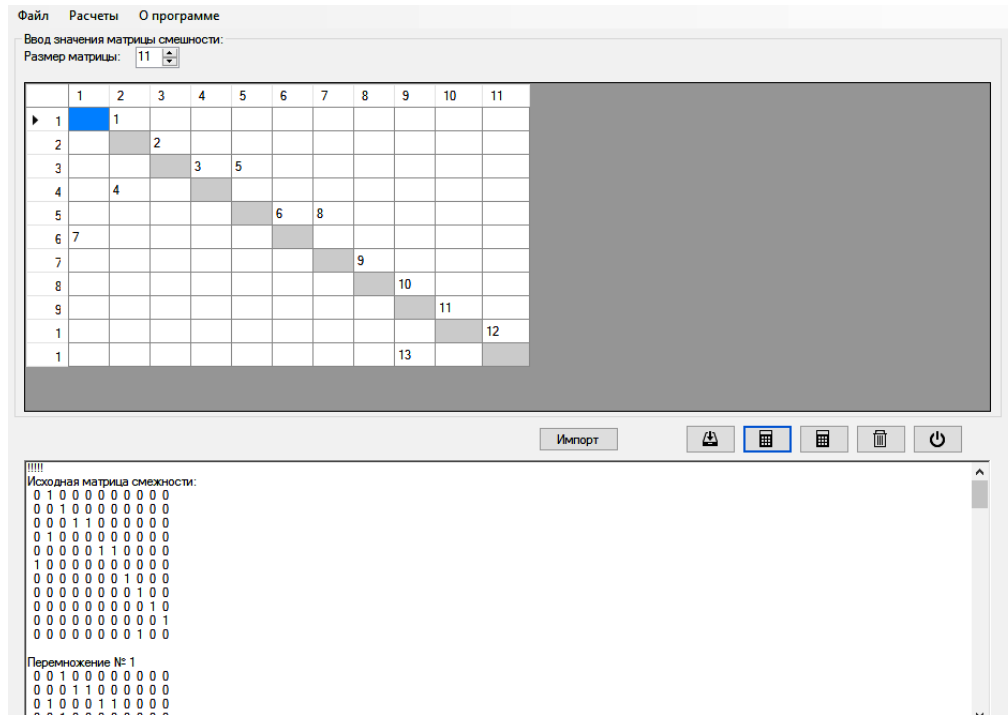

Fig. 6: The developed program interface of complex heat and power system structural analysis

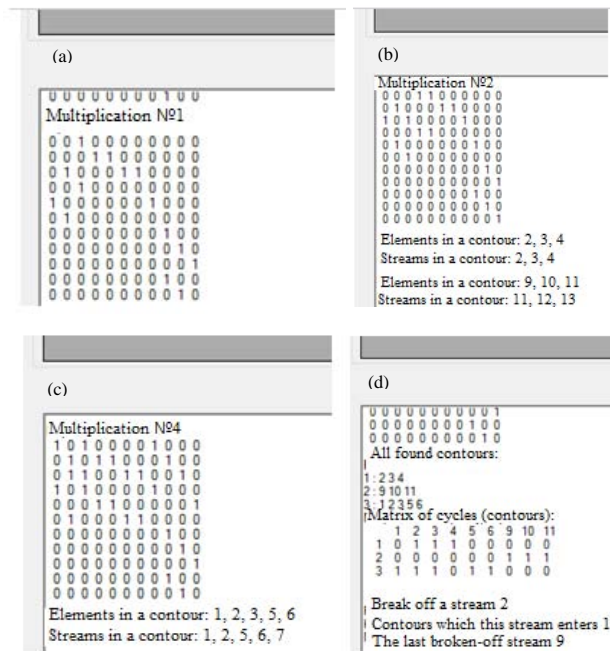

Fig. 7: a) the results of the first multiplication of an adjacency matrix; b) the results of the second multiplication of an adjacency matrix and the identified contours from 3 elements; c) the results of the fourth multiplication of the adjacency matrix and identified contours from 5 elements; d) cycle matrix from the identified loops and conditionally broken streams

Table 2: Software package operation results for heat and power systems of a number of industries

Heat and power system belonging	Number of elements in a system	Adjacent matrix multiplication degree	Amount of determined loops	Amount of broken streams
Ethylene production, pyrolysis section	120	30	254	30
Ethylene production, gas separation section	71	7	29	27
Pulp and paper industry, paper production site	116	69	13	6

these are the flows coming from the elements 9 and 2. Thus, the structural analysis allows to perform the decomposition of the system into separate groups of circuits and to reduce the calculation of a power heating system to the calculation of balance equation systems for separate loops.

The considered above structural analysis allows to imagine complex structured systems in the form of an open sequence of elements and to determine the conditionally linear sequence of calculation. For heat and power systems it is expressed in the form of the opportunity for the determination of the best sequence for system thermal process calculation, i.e., to spend a simplified sequential calculation of a power heating system during a next stage to analyze the energy efficiency of existing technology (Nazmeev and Konahina, 2001; Pleshivtseva and Afinogentov, 2008; Popyrin, 1978).

So, using the developed program they carried out the search of an optimal structure for complex heat and power systems for a number of industries, the results of structural analysis of which are presented in Table 2.

The aim of the next phase, i.e., the thermodynamic analysis is a comprehensive qualitative assessment of consumed energy resources, the analysis of the initial heating system with the consequent definition of places with the greatest energy losses and as the result, the identification of promising ways for process thermodynamic efficiency increase.

CONCLUSION

The implementation of the developed software system allows to reveal the presence of reverse energy channels and material in a thermal power system which will allow to calculate the loops created by these backflows with a preliminary “break” on one of their streams and then to perform the iterative negotiation of conditionally input and output variables that determine the value of stream parameters. Besides, during the process of analysis the program allows to exclude from the analysis area those equipment elements that do not determine the calculation of loop parameters. This

approach greatly facilitates the calculation of virtually any industrial heat power system as well as other complex structured schemes.

ACKNOWLEDGEMENT

The research was produced with the support of the Russian Federation Ministry of Education and Science.

REFERENCES

- Nazmeev, Y.G. and I.A. Konahina, 2001. The Organization of Energotechnological Facilities in Petrochemical Industry. MEI Conlux Company, Reading, England, Pages: 364.
- Nazmeev, Y.G. and I.A. Konahina, 2002. Heat and Power Systems and a Power Balances of Industrial Enterprises. MEI Conlux Company, Reading, England, Pages: 407.
- Pleshivtseva, Y.E. and A.A. Afinogentov, 2008. The optimal management by energy-technological processes in industrial facilities. Proc. Higher Edu. Inst. Electro. Mech., 3: 51-55.
- Plotnikova, L.V., A.A. Zvegintsev, L.A. Kashipova, R.A. Ishmurov and N.K. Nuriyev, 2015. Software implementation of complex structured system analysis for the chemical-technological scheme of petrochemical production. Bull. Kazan Technol. Univ., 18: 198-202.
- Plotnikova, L.V., O.G. Petrova and V.V. Plotnikov, 2010. The development of complex structured settlement model for heat technological scheme of petrochemical production. News Higher Edu. Inst. Prob. Energie., 9: 21-27.
- Popyrin, L.S., 1978. Mathematical Modeling and the Optimization of Thermal Power Plants. Energia Publisher, Texas, USA., Pages: 416.
- Shelginsky, A.Y., 2010. The creation of rational energy technology complexes for industrial enterprises an effective way for basic energy saving problems solution. Training Experts Ind. Power, 8: 4-8.
- Smimov, D.K. and N.N. Galashev, 2012. Program complex for the visual simulation of thermal power plant schemes. Bull. Tomsk Polytechnic Univ., 320: 36-40.