

Application of the Silicon Sensor to Measure and Control the Irradiance of the Solar Simulator by Using LabVIEW

Napat Watjanatepin, Patcharanan Sritanauthaikorn and Chaiyant Boonmee
Solar Energy Research and Technology Transfer Center,
Rajamangala University of Technology Suvarnabhumi, Phra Nakhon Si Ayutthaya, Thailand

Abstract: The measurement and control of the solar irradiance of the solar simulator are important because of the V-I characteristic test of the solar cell will be needed to adjust the accuracy of the flux. Many techniques were applied to achieve that. For the past two decades, many ideas were introduced to apply the other types of sensors to measure the irradiance. This study aimed to present the analysis of an error of the silicon sensor that can be applied to measure the irradiance and control of the light intensity of the LED-based solar simulator by using LabVIEW. The research tools were the first class pyranometer, data-acquisition devices and the LabVIEW Software. The signal conditioner and amplifier circuit is made by an operational amplifier and the silicon sensor is mono-crystalline cells 90 mA/0.5 V. The results found that the silicon sensor can be used for the irradiance measurement. It can replace the first class pyranometer. The relationship between the measurement results is a linearly. The measurement error by RMSE method is equal to 1.69%. The LabVIEW Software can be applied to control the irradiance of the LEDs-based solar simulator perfectly. However, the controlling time gets a bit of a delay due to the delay time of the signal conditioner and amplifier circuits. The next studies the researcher has to reduce the size of the sensor by apply the photodiode to be an irradiance sensor.

Key words: Silicon sensor, control of irradiance, data-acquisition, LabVIEW, solar simulator

INTRODUCTION

The solar irradiance can transform directly to heat and electricity. These are necessary for all area of the World that need to consume the heat energy and the electrical energy in order to apply them to drive the industry, transportation, business sector and for the resident to keep the development going forward. The World cannot lack of potential energy and the solar energy due to the importance that such potential energy is considered as green energy. Now a days, researchers continuously study ways to convert or transform the solar irradiance to be an electrical energy. They are therefore, very interesting topic to study. The unit of the solar irradiation or radiation flux density is watt per square meter (W/m^2). The way to measure the solar irradiation is to get the exact value of its very interests. This is because of the non-exact value of irradiance will create errors during the transformation process. The pyranometer is used to measure the solar irradiance. The standard of pyranometer was defined by the International Standard ISO 9060:1990 and the World Meteorological Organization (WMO) guide 6th. They are classified into 3 classes such

as: the secondary standard class (high quality). The first class (good quality) and the second class (moderate quality). The secondary standard pyranometer is the best class which means that the cost is very high. For the past two decades, many researchers introduce other types of sensors to measure the solar irradiance to replace the high-class pyranometer. The silicon sensor is the one of sensor that widely used for that application.

The researcher needs to improve the accuracy of the measurement by reducing the measurement error. This can be done to increase the efficiency of the solar irradiance instruments. The researcher has to concern about the noise elimination and signal conditioner circuits by using the high input impedance and high slew rate of the operational amplifier. Moreover, the LabVIEW Software has to be applied to measure and display the solar irradiance under testing conditions. This method will help the measurement system to attain suitable use. The graphics of the measurement result will be beneficial for the user because they will be able to visualised the trend of measurement and be able to compare with the previous measured data. They can make a report based on their information and can set up their own databases on their

laptops. The virtual instrument by LabVIEW environment will be able to apply in the laboratory is very suitable and also with high performance. This all depends on the type of the data acquisition hardware that they use. The researcher has created the LED-based solar simulator for testing the voltage and current characteristic of the solar cell in the laboratory. The test plane is around 450 cm². The light source is the array of high power LED. The first objective of this research is to analyse the error of the silicon sensor (mono-crystalline solar cell) that was applied to measure the irradiance of the LEDs based solar simulator. The second purpose is to control the irradiance of the LED-based solar simulator by using LabVIEW.

Literature review: The study of Rosiek *et al.* (2008) was presented the application of PV cell sensor with the 16 bit microcontroller to measure solar irradiance for the weather station located at about 100 km from the University of Almeria. The study results found that this system can be used for complete weather measurement when compared with the system from Campbell Company and the HOBO 8. Benghanem (2009, 2010) reported the mono-crystalline silicon cell from Radio shack (model SC1 980-1045) apply with the wireless data acquisition system under the LabVIEW environment. These results were desirable and at a low-cost. Watjanatepin and Boonmee developed the 4.5 mW of silicon cell sensor to measure the solar irradiance for the microcontroller based weather station. The measurement error of irradiance was about 4.5% on the 200-1000 W/m². The idea of Garcia *et al.* (2014) presented the c-Si sensor size 22.3 mW for the low-solar irradiance measurement. Vivar *et al.* (2013) was present a new type of low-cost sensors using photovoltaic solar cells that provide information about received irradiance and measure an UV irradiance and sunshine duration is presented.

However, there were other papers that indicated applications of the silicon sensor for the other type of measurement such as laser beam and low-irradiance measurements (Carabe *et al.*, 2000; Calderon *et al.*, 2006).

MATERIALS AND METHODS

Design of the system

The overview of the design of the measurement and control unit: The design of the measurement and control unit of the solar irradiance for the solar simulator is shown in Fig. 1. There are five main parts as follow: mono-crystalline solar cell 0.5 V/90 mA the dimension is 45×45 mm. The signal conditioner and amplifier circuit by using the operational amplifier integrated circuit. The data acquisition device, it is NI 6800-USB. This device will be

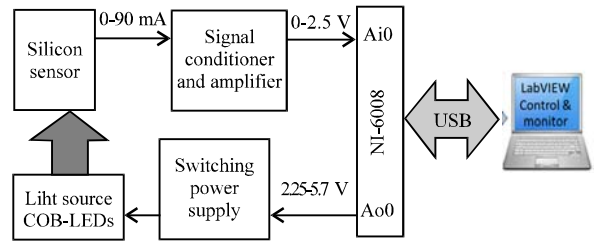

Fig.1: Control and measurement system

interfaced between the hardware and computer software by the USB port. The switching power supply for driving the high power LED (light source). The LEDs array consists of the eighteen of chip-on-board light emitting diodes. Each capacity is about 50 W/32 V.

The light emitting diode circuit: The LED type that was used in this study was the chip-on-board LEDs. Each LED consumes about 50 W of power at 32 V and 1.5 A. The color of light is warm-white. They are connected in three columns of six parallel with each other and supply from one of the power supply as shown in Fig. 2. The calculated rate of the switching power supply is as follow via these equations. Lastly, the power supply capacity is 400 W 34 V, there are three sets in total as shown in Fig. 2.

The design of the irradiance sensor circuit: The output characteristic of the silicon sensor is 0.5 V at 90 mA. This means that the sensor could supply 90 mA of electric current when the sensor receives the solar irradiance of 1000 W/m². I_{sc} is 90 mA, Irradiance is 1000 W/m² when I_{sc} is short circuit current (A) of the sensor and Irradiance is the solar irradiance (W/m²).

The output signal that the author define is the DC voltage, the research need the maximum output voltage of 2.5 V. The author must design the signal conditioner and amplifier circuit for converting the current to voltage and gain the output voltage. The block diagram of the design circuit is shown in Fig. 3. The signal conditioner and amplifier based on the operational amplifier are comprised of the current to voltage converter and inverting amplifier circuit. The current to voltage converter would receive the current from the sensor and convert them to voltage. After that the inverting amplifier will change the negative voltage to the positive voltage. This voltage will show the level of irradiance. If the voltage is about 2.5 V, this will mean that the sensor receive 1000 W/m² of irradiance. The circuit is as shown in Fig. 4. The resistor R₁ was about 27.8 Ω theoretically via. calculation but the actual value of R₁ = 27 Ω because the author chose from the standard resistance value. This has an effect on the output voltage would be <2.5 V. The design of all elements in the circuit

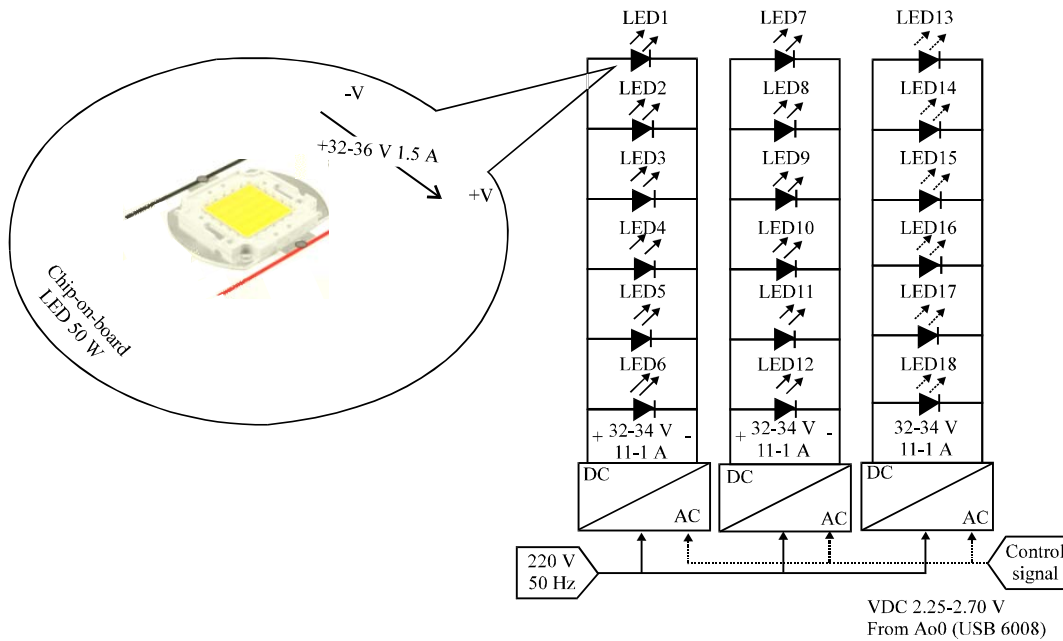

Fig. 2: Chip-on-Board LED circuit and the power supply diagram LED = 50 W/32-34 V/1.50 A connected to 6 parallel of LEDs; $V_{max} = 34V$; $I_{max} = 1.5A \times 6 \times (1.25) = 11.25 A$; 1.25 is a safety factor; $P_{max} = 34V \times 11.25$; $A = 382W$

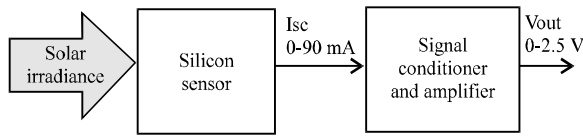

Fig. 3: The block diagram of the sensor circuit

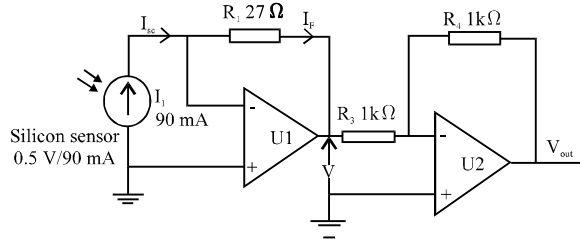

Fig. 4: The signal conditioner and amplifier circuits

are shown in Fig. 4, the current to voltage converter (U1) can be calculated by Eq. 1. The inverting amplifier (U2) can calculate by using Eq. 2:

$$V = -I_F R_1 \quad (1)$$

Where:

$$R_1 = -V/I_F$$

$$I_F = I_{sc}$$

$$R_1 = -2.5 V/90 mA = 27.8 \Omega \text{ (Standard R = } 27 \Omega, 0.5 W \pm 1\%)$$

$$V_{max} = -90 mA \times 27 \Omega = 2.43V$$

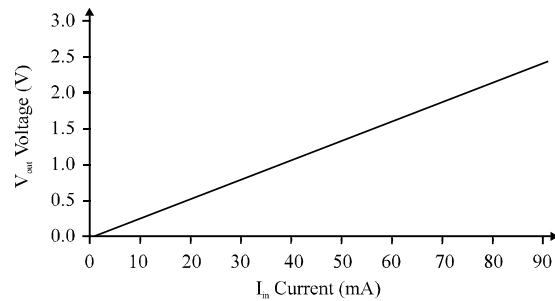

Fig. 5: The simulation results of circuit in Fig. 4. by NI-Multisim; DC transfer characteristic

$$V_{out} = A_v V \quad (2)$$

Where:

$$A_v = R_4/R_3 \text{ define the } A_v = -1 \text{ that recommended } R_3 = R_4 = 1 k \Omega$$

$$V_{out} = -1(-2.43 V) = 2.43 V$$

The circuit simulation's purpose is to check the results of the designed circuit by creating the circuit from Fig. 5 and simulating by the NI Multisim Software. The maximum input current or the I_{sc} was defined to be 90 mA. The simulation results of the voltage $V = -2.43 V$ and the output voltage or V_{out} is about 2.43 V. The plotting of the transfer-characteristic curve shows the relationship of the input current and the output voltage ($I_{sc} = f(V_{out})$). This relationship is a linear equation which means that the

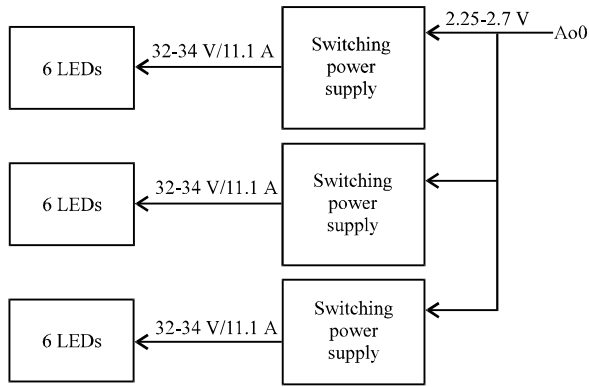

Fig. 6: The control of the artificial irradiance diagram

output voltage will change linearly with the solar irradiance. The output voltage from this circuit will be sent through the analog input port (Ai0) of the NI 6008-USB in the next step.

The control of the artificial irradiance: The control of the DC supply voltage to LEDs circuit. If the supply voltage is adjusted to the maximum 34 V, the LEDs will generate the highest irradiance. The adjustable input is able to control the DC voltage between 2.25-2.70 V. This control voltage could be generated from the LabVIEW Software and send through the analog output port Ao0 of the NI 6008-USB. This signal will control the irradiance of the LED in the next step. The conceptual diagram is as shown in Fig. 6

Data acquisition device: The data acquisition device is an equipment that acquires the data from the sensor and send the control output signal to the hardware devices by using the input and the output port. In this study, the NI USB-6008 and the LabVIEW Software. The NI USB-6008 can interface with the computer by the USB port without other power supplies. There are 8 analog inputs, 2 analog outputs and 12 digital input/output. The NI-DAQmx driver software is downloaded and installed with the supported by the website of the national instrument. This study used one of Analog inputs (Ai0) for receiving the measurement data from the sensor and one port of an Analog output (Ao0) for the control irradiance of the LEDs solar simulator.

The software development: According to Fig. 7, the flow chart of the software development is shown step by step for the irradiance control and measurement software which were developed by using LabVIEW. The results of development will be shown in two parts: the front panel which is for the user interface as shown in Fig. 8 user can

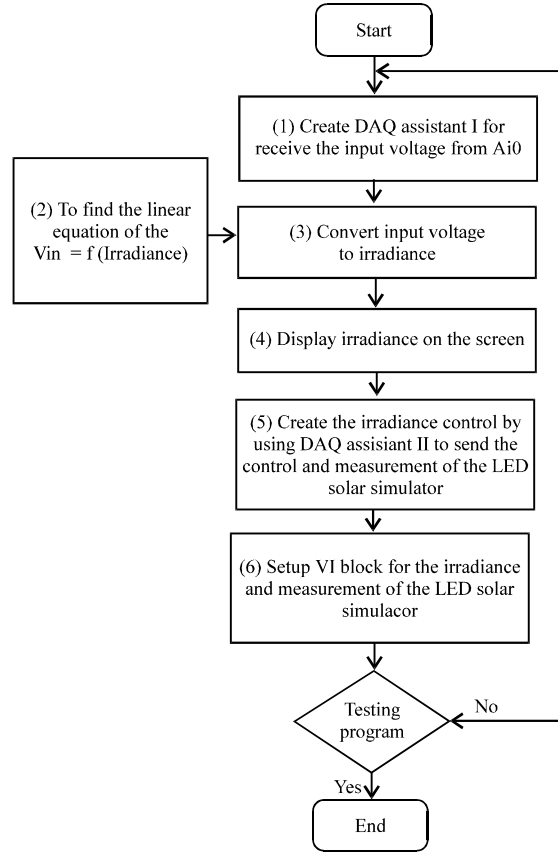

Fig. 7: The flow chart of the software development

control the irradiance of the solar simulator by turning the control knob or enter the value of control voltage between 2.25-2.70 V. The VI-block diagram which is the graphical program for controlling and measuring the solar irradiance as shown in Fig. 8. The VI block will show the DAQ Assistant and DAQ Assistant 2 which are used for the generation of the control voltage to control the irradiance by sending the DC voltage to the input of three switching power supplies.

The DAQ assistant 3 is used for receiving the measurement data from the silicon sensor and signal conditioner and amplifier circuit which then will be displayed on the screen numerically and with an indicator. To find out the relationship between the input voltage of the DAQ assistant 3 (DC output voltage from the signal conditioner and amplifier) and the irradiance of the solar simulator that was measured by the standard pyranometer the standard pyranometer has to be installed at the same position of the silicon sensor and measure the irradiance and DC voltage. The researcher found the relationship graph as shown in Fig. 9 and 10. It is a linear equation as shown in equation $y = 455.53x - 62.73$ should be used to be the multiple (455.53) and offset (-62.73) of the transformation from irradiance to voltage.

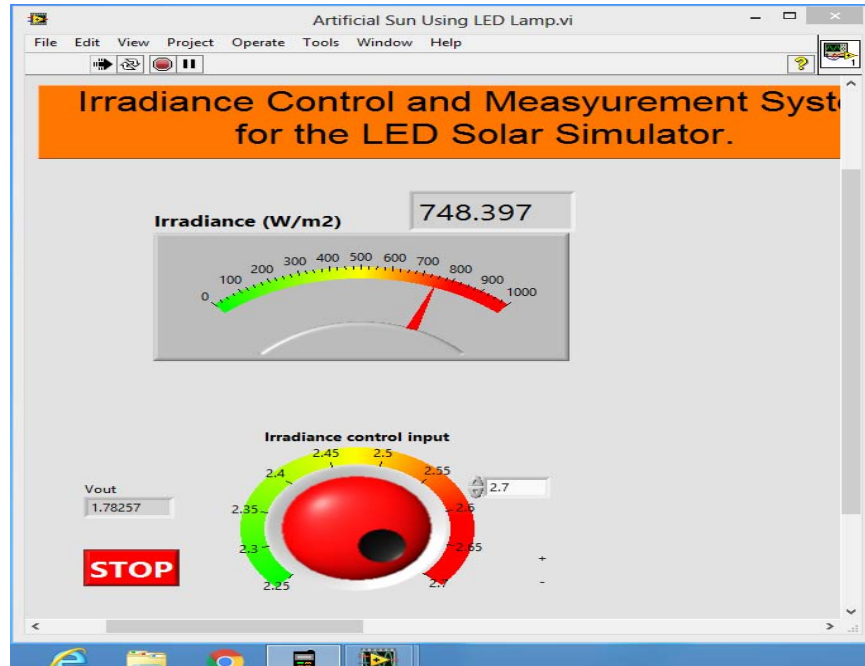

Fig. 8: The front panel of the irradiance control and measurement system

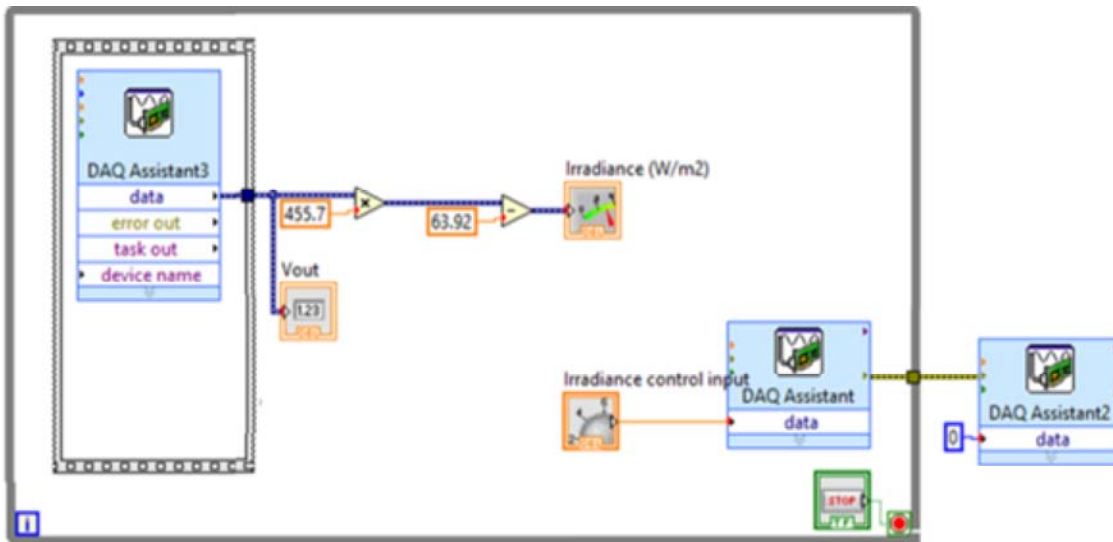

Fig. 9: The VI Block of the irradiance control and measurement system

Experimental setup: The experimental equipment's is as follow: laptop with the irradiance control and measurement software. The data acquisition device NI USB-6008. Three sets of the switching power supplies 400 W 34 V. Silicon sensor and the signal conditioner and amplifier circuit. The LED-based solar simulator 900 W. Pyranometer and data logger and install at the center of the test plane as shown in Fig. 11.

Experiment 1: The irradiance control by using LabVIEW:

- Install the equipment by referring to Fig. 11
- Turn on the switching power supply
- Run the irradiance control and measurement software
- Install the pyranometer and run the software to display the irradiance

- Enter the value of control voltage from 2.25-2.70 V with a step of 0.5 V
- Record the measured irradiance
- Repeat 3 times the experiment and find out the average value of measurement and enter in Table 1
- Turn off the switching power supply
- Install the equipment by referring to Fig. 11
- Turn on the switching power supply
- Run the irradiance control and measurement software
- Install the pyranometer and run the software to display the irradiance
- Enter the value of control voltage from 2.25-2.70 V with a step of 0.5 V
- Record the measured irradiance from pyranometer and silicon sensor in Table 2

Experiment 2: Find out the relationship between the measured irradiance from the silicon sensor and the standard pyranometer:

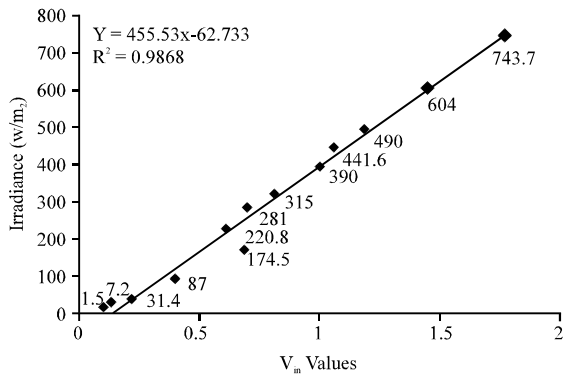

Table 1: The control voltage and the output irradiance

$V_{control}$ (V)	V_{out} (V)	Irradiance (W/m^2)
2.70	1.78	743.70
2.65	1.45	604.00
2.60	1.19	490.00
2.57	1.06	441.60
2.55	1.00	390.00
2.52	0.81	315.00
2.50	0.70	281.00
2.47	0.68	220.80
2.45	0.61	174.50
2.40	0.40	87.00
2.35	0.22	31.40
2.30	0.11	7.20
2.25	0.09	1.50

Fig.10: The linear of $V_m = f$ (Irradiance) of the silicon sensor

Table 2: RMSE and MBE analysis by the different instruments

Measurement of solar irradiance	MBE (%)	RMSE (%)
Silicon sensor/standard pyranometer	-0.378	1.69

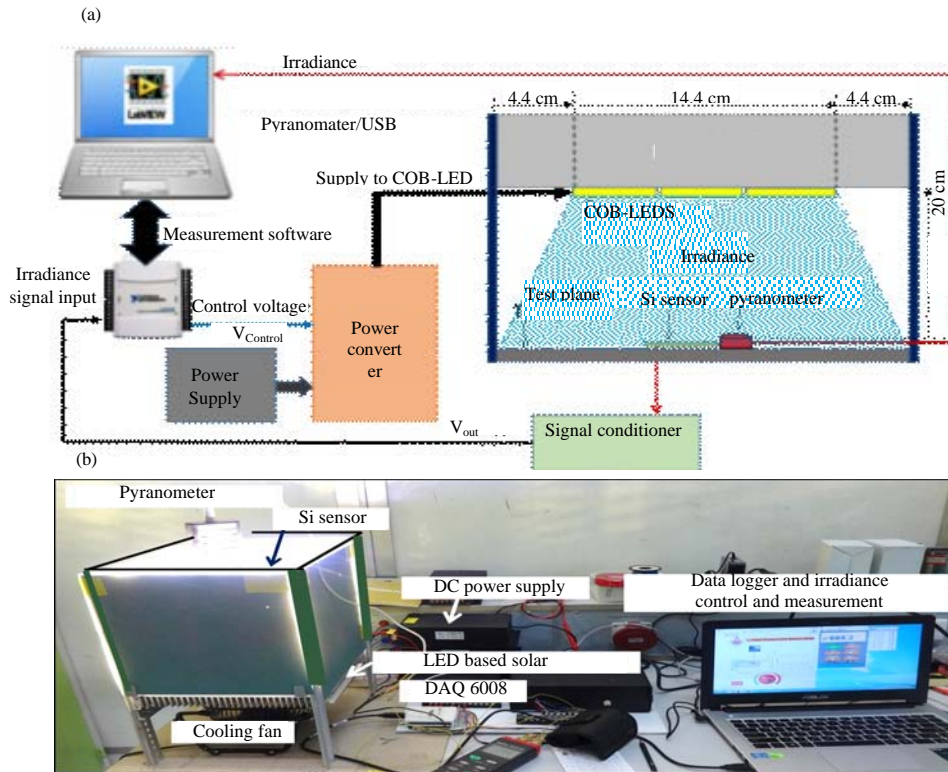

Fig. 11: The experiment diagram

- Turn off the switching power supply
- Make a scatter plot of the relationship of measured irradiance from pyranometer and the silicon sensor
- Analyses the error of the silicon sensor by using the root-mean square error

RESULTS

The irradiance control by using LabVIEW: The software that the research developed is as shown in Fig. 12. The control knob is the irradiance control input. This function can control the irradiance of the LED-based solar simulator. The controlled results are as shown in Table 1. The screen could show the measured irradiance numerically and with an indicator as shown in Fig. 12.

The results found that the control and measuring software that was developed can control the irradiance of the solar simulator. The control voltage is 2.25 V and the system can generate the irradiance of about 1.50 W/m². If the control voltage is increased, the irradiance will

increase linearly. If the control voltage is set to the maximum 2.70 V the maximum irradiance is about 743.70 W/m². Also, the measured irradiance from the silicon sensor can be displayed correctly. Figure 12 could show the comparison of the measured value from the software LabVIEW and the standard pyranometer.

The relationship of the measured irradiance from silicon sensor and pyranometer: This relationship is shown in the scatter diagram in Fig. 13. This is the positive relationship when considering as a linear graph. The research found that the graph's slope is about 1.00012 and the value of R² = 1. This means that the trend of the two variables is very well in accordance. The measured irradiance from the silicon sensor could predict the actual irradiance. The linear equation is as shown in equation $y = 1.00012x - 0.8156$ where y = measured from silicon sensor (W/m²) and x = measured from standard pyranometer (W/m²).

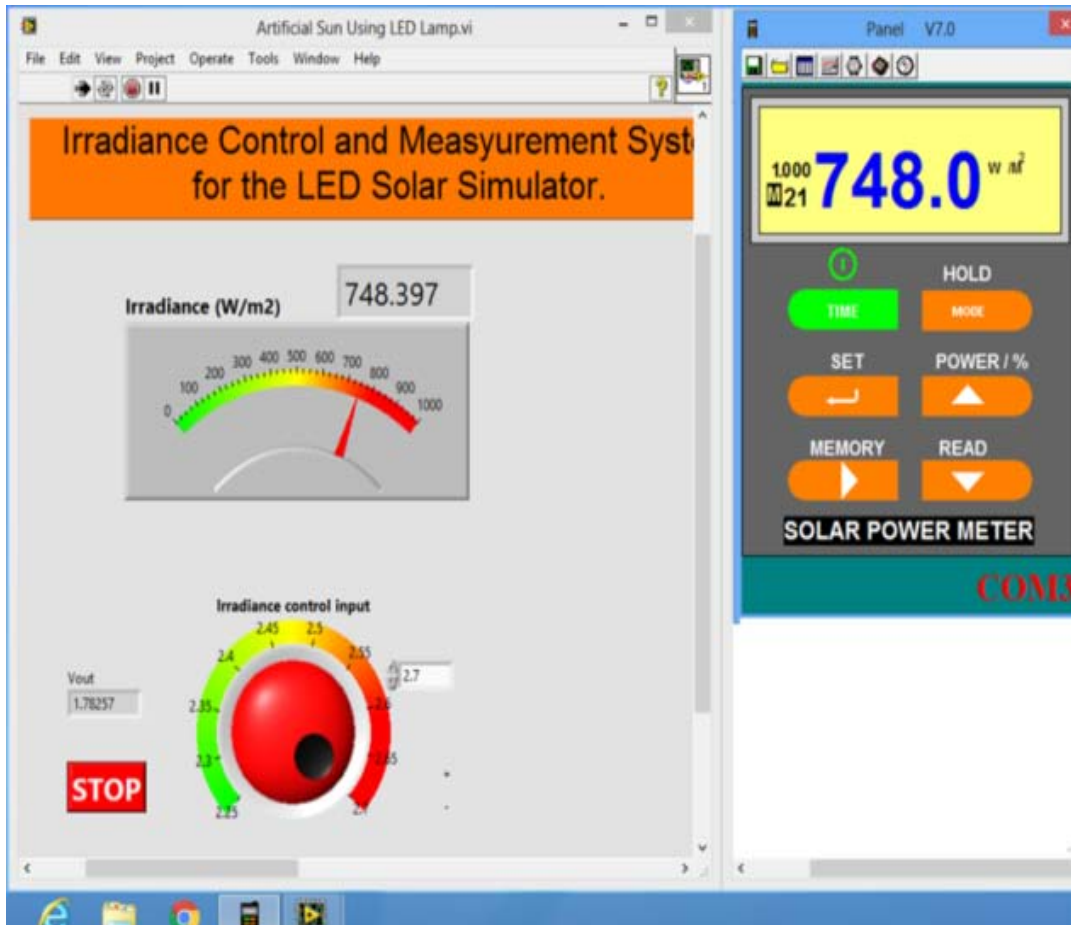

Fig. 12: Front panel of the control and measurement program

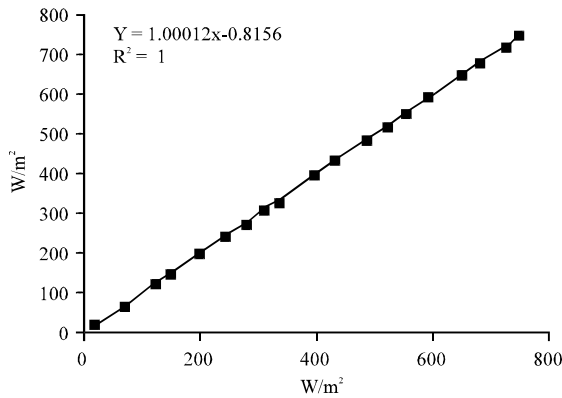

Fig. 13: The scatter plot of measured irradiance from the silicon sensor and the standard pyranometer

From $y = 1.00012x - 0.8156$, if x is a small value, the y value will be significantly different. For example, if $x = 10 \text{ W/m}^2$, the value of $y = 9.14 \text{ W/m}^2$. The calculated percentage error is equal to 8.14%. On the other hand if $x = 700 \text{ W/m}^2$, the value of $y = 699.27 \text{ W/m}^2$. The measurement error is only 0.10%. From this study, it can be concluded that the pyranometer can replace the silicon sensor. But the silicon sensor is not appropriate for the low irradiance measurement.

Analysis the error of the silicon sensor: The measurements of the irradiance from the silicon sensors and the standard Pyranometer were collected by the LED based solar simulator in the laboratory as illustrated in Fig. 12. The data from this experiment is related in the terms of forming a linear equation. The researcher could analyses the errors with the meaning of the Root-Mean-Square Error (RMSE) and estimate the tendency of measurement by using the Mean Bias Error (MBE) (Mahjoubi *et al.*, 2012). The RMSE informs about the dispersion of the experimental data and it is defined as:

$$RMSE = \left(\frac{\sum (X_{std} - X_{mea})^2}{N} \right)^{1/2} \quad (3)$$

$$MBE = \frac{\sum (X_{std} - X_{mea})}{N} \quad (4)$$

Where:

X_{std} = The data measured by the standard pyranometer

X_{mean} = The data measured by the silicon sensor

The MBE informs is about the tendency above the underestimation of the testing data and it is expressed by the following Eq. 4. The calculation results of the measurements error from Eq. 3-4 as show in the Table 2.

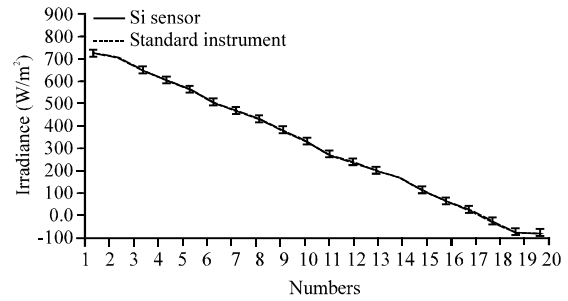

Fig. 14: The irradiance measured from silicon sensor, standard pyranometer

According to Table 2, the irradiance that is measured by the silicon sensor and the standard Pyranometer is very close to each other. The error by RMSE method is equal to 1.69 % which is close to zero. This means that the irradiance measured by the silicon sensor is at a very high accuracy and with low deviation. The MBE will show that the error of the silicon sensor has a deviation from the mean value of irradiance of about -0.378 %. This is a very low value, the MBE method could explain that the silicon sensor can measure the irradiance lower than the actual irradiance of -0.378% from the mean value.

However, Fig. 14 displayed the graph of measured irradiance from the standard pyranometer (red dot line) and silicon sensor (blue line). There is a perfect overlap with each other which shows that the silicon sensor is very good for irradiance measurement.

DISCUSSION

The control of irradiance from the LabVIEW Software concedes to a bit of time delay which is around a second. However, for the user, the delay of the control command does not decrease the control accuracy. In the same way, the measured irradiance will have a bit of a delay time when they are being display on the screen. The cause of the control command delay time may arise from two causes which are the delay of the N1-6008-USB interface and the delay of the operating of the switching power supply. With the delay time of the N1-6008-USB, the author cannot adjust them because of the fact that it is a low-cost data-acquisition system. To reduce the delay time, one might have to use the compact DAQ or the cRIO. There is an industrial type with fast speed but more expensive.

The cause of delay time of the measured display might be from the operating time of the operational amplifier in the signal conditioner and amplifier circuits because the slew rate of the OP-amp UA741 is too low. It is about 0.5 V/μS. This cause can be improved by

changing the ICs UA741-OPA656 or OPA657. They are high slew rate which is equal to 290 V/ μ S. The silicon sensor (PV) is appropriate to be applied for measuring the irradiance because for the solar cell testing, the irradiance is kept between 400-1000 W/m². However, the problem is the size of silicon sensor which is about 4.5×4.5 cm. It is too large when compare with the other sensor such as the photodiode or phototransistor which has a much smaller size of around 1 cm². That according with an idea of Tina *et al.* (2013). Lastly, the silicon sensor is very good for replacing the Pyranometer because the error of measurement is very low.

CONCLUSION

The silicon sensor (mono-crystalline solar cell) can be applied to measure the irradiance of the solar light with high accuracy, low measurement error and low-cost. The silicon sensor is very appropriate to replace the pyranometer. This is very interesting because the cost of pyranometer is very high. And thus, this is beneficial in order to reduce the cost of importing the pyranometer from abroad.

The silicon sensor with LabVIEW could form a complete and improved measurement system that is capable of measuring, controlling and monitoring the system. This system can be a data-logger by using the MySQL database available in the laptops. They are adjustable to meet the function that the user requests. However, for the next study, the researcher has to reduce the size of the sensor by apply the photodiode (that have a wide wave range) to be an irradiance sensor to study and compare with the other type of sensors.

ACKNOWLEDGEMENTS

Thank you for Rajamangala University of Technology Suvarnabhumi for supported the research budgets. Thank you for electrical engineering students group EE15631N that help the researcher to assemble the prototype of an LED based solar simulator.

REFERENCES

- Benghanem, M., 2009. Measurement of meteorological data based on wireless data acquisition system monitoring. *Applied Energy*, 86: 2651-2660.
- Benghanem, M., 2010. Retracted: A low cost wireless data acquisition system for weather station monitoring. *Renewable Energy*, 35: 862-872.
- Calderon, A., M.C. Rivero, F. Matorras, T. Rodrigo and M. Sobron *et al.*, 2006. Large-size high-performance transparent amorphous silicon sensors for laser beam position detection. *Nucl. Instrum. Methods Phys. Res. Sect. A. Accelerators Spect. Detectors Associated Equip.*, 565: 603-611.
- Carabe, J., M.G. Fernandez, A. Ferrando, J. Fuentes and J.J. Gandia *et al.*, 2000. Results on photon and neutron irradiation of semitransparent amorphous-silicon sensors. *Nucl. Instrum. Methods Phys. Res. Sect. A. Accelerators Spectrometers Detectors Associated Equip.*, 455: 361-368.
- Garcia, M.M.A., M.A. Herreros, J.L. Balenzategui and P. Barrerio, 2014. Low-cost irradiance sensors for irradiation assessments inside tree canopies. *Solar Energy*, 103: 143-153.
- Mahjoubi, A., R.F. Mechlouch and A.B. Brahim, 2012. Fast and low-cost prototype of data logger for photovoltaic water pumping system. *Intl. J. Sustainable Energy*, 31: 189-202.
- Rosiek, S. and F.J. Batlles, 2008. A microcontroller-based data-acquisition system for meteorological station monitoring. *Energy Convers. Manage.*, 49: 3746-3754.
- Tina, G.M., F. Arcidiacono and A. Gagliano, 2013. Intelligent sun-tracking system based on multiple photodiode sensors for maximisation of photovoltaic energy production. *Math. Comput. Simul.*, 91: 16-28.
- Vivar, M., M. Fuentes, G.R. Pacheco and D.I. Bustamante, 2013. Clean water photovoltaic sensor for solar disinfection in developing countries. *Solar Energy Mater. Solar Cells*, 117: 549-563.