

## Design of Microstrip Patch Antenna at 900 MHz for Charging Mobile Applications

E.M. Ali , N.Z. Yahaya, N. Perumal and M.A. Zakariya  
Department of Electrical and Electronic Engineering, Universiti Teknologi Petronas,  
Bandar Seri Iskandar, 31750 Tronoh, Perak, Malaysia

**Abstract:** This research provides a guideline for designing a microstrip antenna for charging mobile applications. It will be a new source for new researchers to investigate on antenna design and keep with the latest progress in this area. This design is developed using transmission line model. The proposed module had been designed to operate in GSM band range 900 MHz. The simulation carried out for different materials substrate with different dielectric constant values; FR-4 ( $\epsilon_r = 4.3$ ), Roger 8550 ( $\epsilon_r = 2.2$ ) and Perspex glass ( $\epsilon_r = 3.4$ ). This study showed that smaller values of dielectric constant will generate larger size of microstrip antenna. Antenna parameters are compared such as gain, radiation pattern and return loss for the three modules. Prototyping of the antenna of  $\epsilon_r = 4.3$  is illustrated as a design example. It had been proved by using it in charging mobile charging project. The proposed antenna harvests the RF power then it had been converted to DC voltage to charge the battery of mobile. These results show that this antenna and the method are a good choice for charging using RF harvesting. The proposed antenna had been chosen to transmit the power as a transmitter antenna then receive it using rectenna (antenna integrated with rectifier circuit) for charging mobile applications the experiment worked successfully.

**Key words:** Inset feed, transmission line model, rectenna, transmitter antenna, receiver antenna, wireless transmission

### INTRODUCTION

Wireless communication systems require simple antennas which have specifications in term of small size, light weight and good gain (Kashwan *et al.*, 2011). The outputs of these antennas depend on key factors like dimensions, materials and feed line properties (Huque *et al.*, 2011). Antenna performance depends on design parameters. For this reason, choosing the parameters has important rule (Upadhyay and Sharma, 2013). The antenna's size is inversely proportional to its dielectric constant which is related to the material of the substrate (Johnson and Jasik, 1984). Better results like efficiency and bandwidth can be achieved by designing using thicker substrates and lower range of dielectric (Nisha, 2015; Choi, 2015; Mezaal *et al.*, 2015).

This research provides a procedure for designing Microstrip antenna using transmission line method for charging mobile applications. Figure 1 shows the proposed design which contains Microstrip patch antenna which harvest RF energy at 900 MHz frequency, matching circuit which decrease the dissipated power between the antenna and load, rectifier which convert the RF power to DC power to charge the battery. The researchers designed in reported research some types

of rectification circuit which will be used to test output of the proposed antenna (Ali *et al.*, 2014, 2016).

**Design paramters of microstrip patch antenna:** Microstrip patch antenna consists of a flat rectangular patch of metal placed on top of a larger sheet of metal which called a ground plane as shown in Fig. 2. Substrate of dielectric constant is placed between the patch and the ground plane.

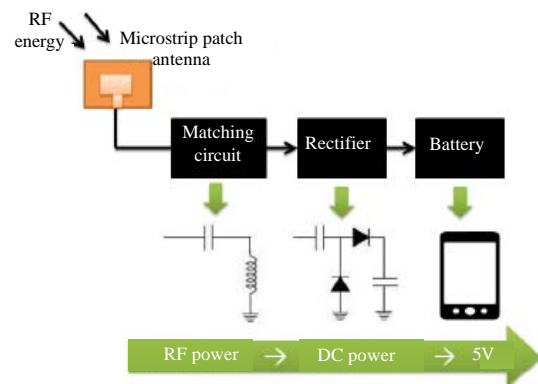

Fig. 1: Block diagram of the RF harvesting circuit for mobile charging

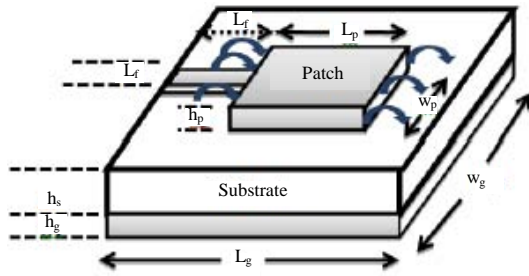

Fig. 2: Layout of rectangular patch antenna; the typical structure of microstrip patch antenna contains the parameters of:  $L_p$  = Length of the patch,  $W_p$  = Width of the patch,  $h_s$  = height of dielectric substrate,  $\epsilon_r$  = dielectric constant (Bernard and IzuchukwuIloh, 2013)

### MATERIALS AND METHODS

In this study, the transmission line model method had been used to develop the microstrip patch antenna. First step is finding the design parameters, then simulation, after that fabrication and finally testing and measurements. This design is based on the empirical equations. The basic parameters of the patch antenna are obtained from calculations carried out using the appropriate equations. Our main focus is to obtain data for different values of dielectric constant for different materials of substrate; first design will use FR-4 as substrate with dielectric constant of  $\epsilon_r = 4.3$ , second design will be designed using Roger 5880 ( $\epsilon_r = 4.3$ ) and third design will be designed using Perspex glass of dielectric constant of 3.4. The theoretical results is used to run the simulation to study the output. This method represents the microstrip antenna by two slots which separated by a transmission line of length  $L/2$ . By applying the transmission line model, the following calculation steps are used to determine the required parameters for a patch antenna (Balanis, 2016; Derneryd, 1976; Garg *et al.*, 2014; Mezaal, 2016; Schneider, 1969). As mentioned earlier, the calculations were carried out for different values of dielectric constant. The primary step in the design procedure is to determine width of the patch ( $W_p$ ) and the dimension is succeeded to be small enough to avoid excitation of transverse resonance mode, the width dimension is determined as Eq. 1:

$$W_p = \frac{c}{2f\sqrt{(\epsilon_r + 1)/2}} \quad (1)$$

Where:

$c$  = The speed of light, ( $3 \times 10^{11}$  mm sec<sup>-1</sup>)

$f_r$  = The operating frequency

$\epsilon_r$  = The dielectric constant of the substrate

Lower dielectric constant value provides wider impedance bandwidth. The antenna somehow, constitutes a larger element size by using higher dielectric constants. This leads to smaller element sizes and minimize coupling effect. Effective dielectric constant ( $\epsilon_{eff}$ ) can be determined as Eq. 2:

$$\epsilon_{eff} = \frac{((\epsilon_r) + 1)}{2} + \frac{((\epsilon_r) - 1)}{2} \left( \frac{1}{\sqrt{1 + 10h_p/W_p}} \right) \quad (2)$$

Where:

$h_p$  = The height of the patch (mm)

$W_p$  = The width of the patch (mm)

Thicker substrates generate better effectiveness and larger band width where the thinner substrates lead to smaller element size, minimize coupling with reduced efficiency and relatively smaller bandwidths. Equation 3 calculates effective length of the patch ( $L_{eff}$ ): increasing its value leads to increase size of the patch, smaller frequency leads to larger  $L_{eff}$  and larger frequency leads to smaller  $L_{eff}$ .

$$L_{eff} = \frac{c}{2f_r\sqrt{\epsilon_e}} \quad (3)$$

Where:

$h_p$  = The height of the patch (mm)

$W_p$  = The width of the patch (mm)

The substrate of thicker substrates gives better effectiveness and larger band width where the thinner substrates lead to smaller element sizes, minimize coupling with reduced efficiency and relatively smaller bandwidths. The length extension ( $\Delta L$ ) is determined as Eq. 4:

$$\Delta L = 0.412h_p \times \frac{\left( (\epsilon_e + 0.3) \times \left( \frac{W}{h_p} + 0.264 \right) \right)}{\left( (\epsilon_e - 0.258) \times \left( \frac{W}{h_p} + 0.813 \right) \right)} \quad (4)$$

where,  $\Delta L$  is the extended patch length. Increasing its value leads to decreasing of the length and size of antenna, it is unit in mm. The actual length of the patch ( $L_p$ ) using Eq. 5:

$$L_p = L_{eff} - 2\Delta L \quad (5)$$

The above steps were used for each of the selected dielectric constant at resonant frequency of 900 MHz and the results are tabulated in Table 1. It 's clear that the dimensions of the antenna are increasing when the value of  $\epsilon_r$  decreased.

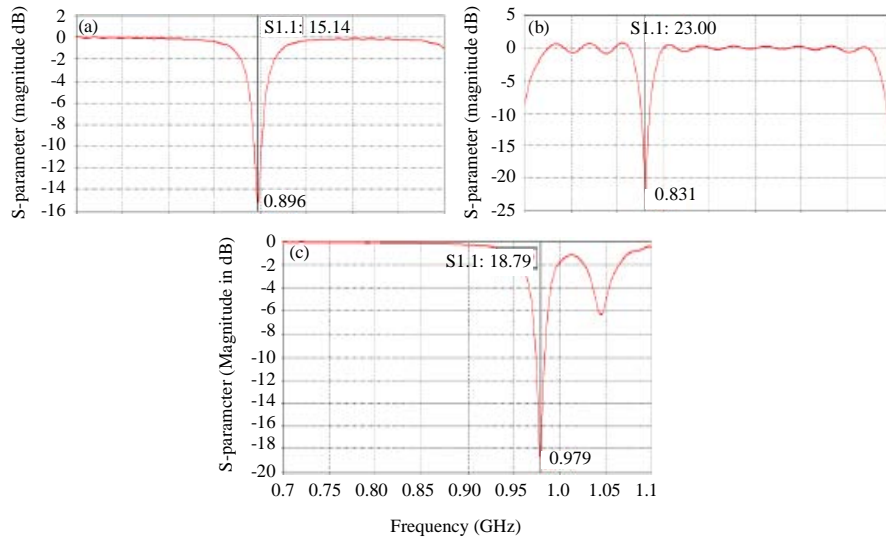

Fig. 3: a) S-parameter (s11) result for dielectric constant 4.3; b) S-parameter (s11) result for dielectric constant 2.2; c) S-parameter (s11) result for dielectric constant 3.4

Table 1: Summary of the calculated results for the three antenna modules

Parameters	Module 1	Module 2	Module 3
Material of the substrate	FR-4	Roger 5880	Perspex glass
Dielectric constant	4.3	2.2	3.4
Thickness of substrate (mm)	1.6	1.57	2
Dimensions of substrate (mm)	146×180	200×250	166×200
Dimensions of the patch (mm)	63*125	90*150	83×145

Table 2: Summary of the simulated results for the 3 antenna modules

Parameters	Module 1	Module 2	Module 3
Material of the substrate	FR-4	Roger 5880	Perspex glass
Dielectric constant	4.3	2.2	3.4
Resonant frequency (MHz)	898.28	830.67	978.8
Return loss (S11)	-14.7	-22.997	-18.786
Bandwidth (MHz)	10.2	6.2	10.1
Gain (dBi)	6.832	3.987	6.844
Radiation efficiency (dB)	-1.954	-7.039	-2.277
Total efficiency (dB)	-2.216	-20.66	-14.56

**Simulation:** The antenna had been simulated utilizing CST Microwave Studio 2014 for the 3 Modules. The simulated antenna return loss curve is plotted in Fig. 3 for different materials of the substrate; FR-4 ( $\epsilon_r = 4.3$ ), Roger 5880 ( $\epsilon_r = 2.2$ ) and Perspex glass ( $\epsilon_r = 3.4$ ). The simulated result for first design shows that the impedance bandwidth covers 893.1-901.9 MHz which is equivalent to 10.2 MHz bandwidth at resonance frequency of 898.27 MHz with a return loss of -14.718 dBi. The return loss in the second design is higher than first design, -23.997; its impedance bandwidth is 6.2 MHz as shown in Fig. 3. Third design generates the wider impedance bandwidth with value of 10.1 MHz and return loss of -18.786.

The simulated results for radiation patterns; H-plane and E-plane for resonance frequency of 900 MHz for the 3 modules. It is clear that H-plane radiation pattern is directional with main lobe directed at zero for first and third design. The directions of the main lobe had been found to be 6.844, 3.987 and 6.832 dBi for the three microstrip patch antenna for dielectric constant 4.3, 2.2 and 3.4, respectively. It is clear that the first design ( $\epsilon_r = 4.3$ ) has the best gain value comparing to other designs. Table 2 shows summary of the simulated values for the three modules.

## RESULTS AND DISCUSSION

According to the geometry configuration and the specifications given in the previous section, the first module antenna had been chosen for prototyping and fabricating on FR-4 Printed Circuit Board (PCB). Figure 4 and 5 shows the picture of the antenna prototyping, testing and measurements setup. The network analyzer ANRITSU model MS2034B is used to test the antenna which is connected to it using SMA connector. The frequency band is set to be at range of (700-1100 MHz).

The measured and simulated data for the first antenna module is compared using Sigma Plot 10.0 as shown in Fig. 6. The software predicted the resonance at 898.28 MHz while measurements pointed to 932 MHz. The simulated return loss is -14.7 dBi while the measured one is -32.49dBi. Table 3 shows the summary of comparison of the simulated and measured results for the first antenna module at dielectric constant of 4.3. It is clear that

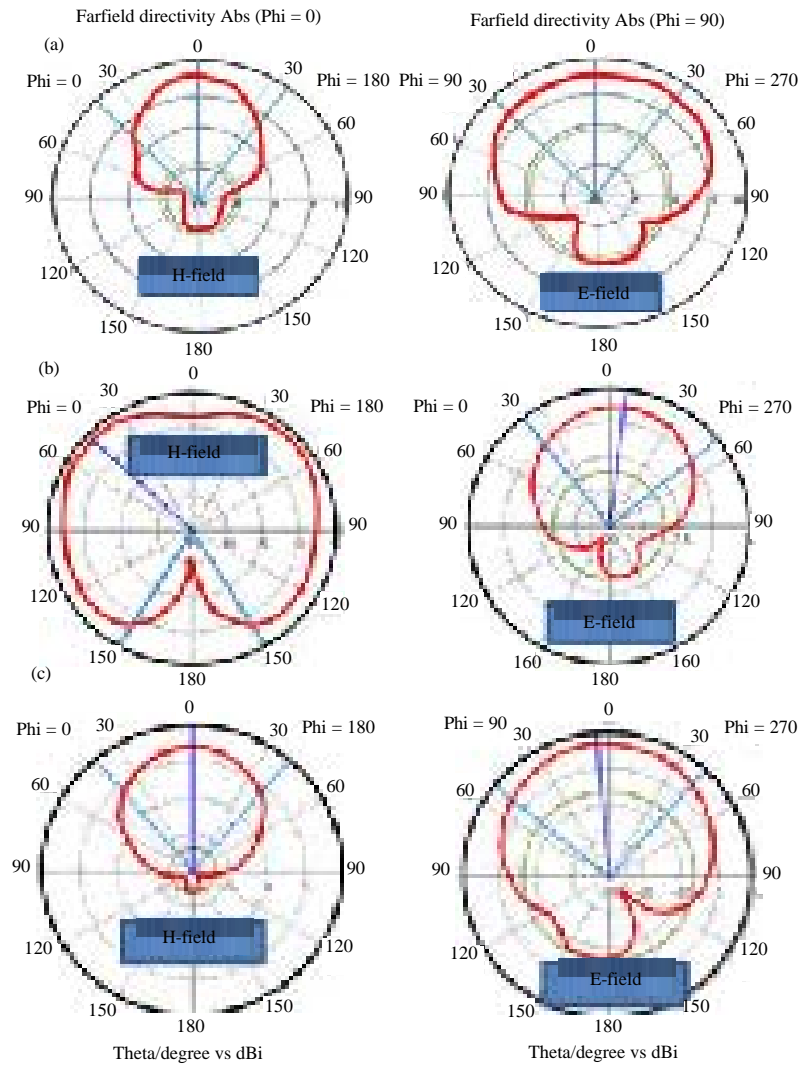

Fig. 4: The H-field and E- field of the microstrip antenna at frequency 0.9 GHz for different values of dielectric constant: a) First design; b) Second design; c) Third design

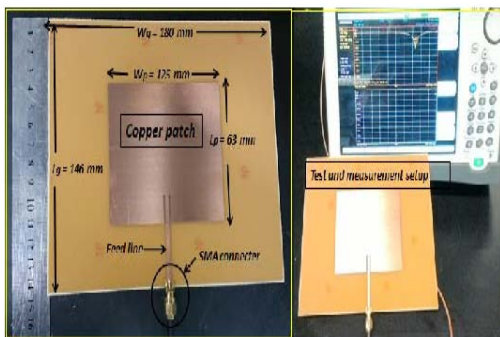

Fig. 5: Microstrip patch antenna prototyping, testing and measurements setup

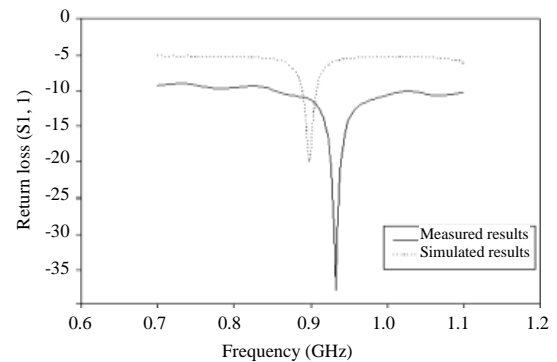

Fig. 6: Comparison between simulated and measured results of return loss curve using Sigma Plot 10.0

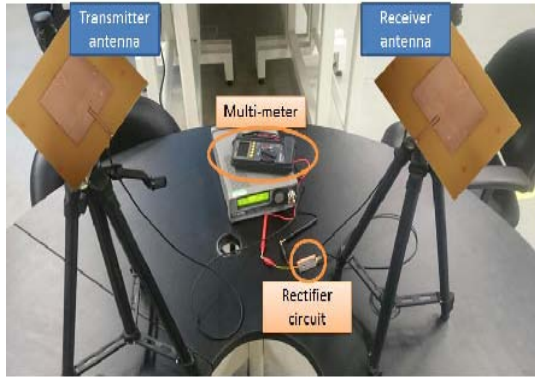

Fig. 7: Experiment to measure the received power from the antenna

Table 3: Summary of the simulated and measured results for the first antenna module

Microstrip patch antenna (FR-4)	Resonance frequency (MHz)	Return loss (S11) (dBi)	Bandwidth (MHz)
Simulated results	898.28	-14.70	10.200
Measured results	932.00	-32.49	25.243

measured results of the antenna has better efficiency because it has higher values in term of return loss (-2.49) and bandwidth (25.243 MHz). These results will enable this antenna to be used in harvesting systems as harvested element in the system.

Comparing to the related work which had been presented in the literature review; the results for the presented antenna module shows a competitive result in terms of return loss, size and bandwidth.

**Mobile charging using wireless power transmission:**

Transfer the power for charging will be proceed using Wireless Power Transmission (WPT) which contains from transmitter antenna, receiver antenna, function generator, multimeter and rectifier circuit. The RF power is carried within a focused microwave beam that travels across free space towards a collector. This receiving block will convert the RF energy back into DC electricity. As shown in Fig. 7. This DC voltage will be used to charge the battery of mobile (Ali *et al.*, 2014, 2016).

Figure 8a shows the results for wireless power transmission for microstrip patch antenna at 900 MHz. It's clear from the figure that higher power input values generate higher received power for Microstrip patch antenna. While Fig. 8b shows the received output voltage using 3 types of rectification circuit.

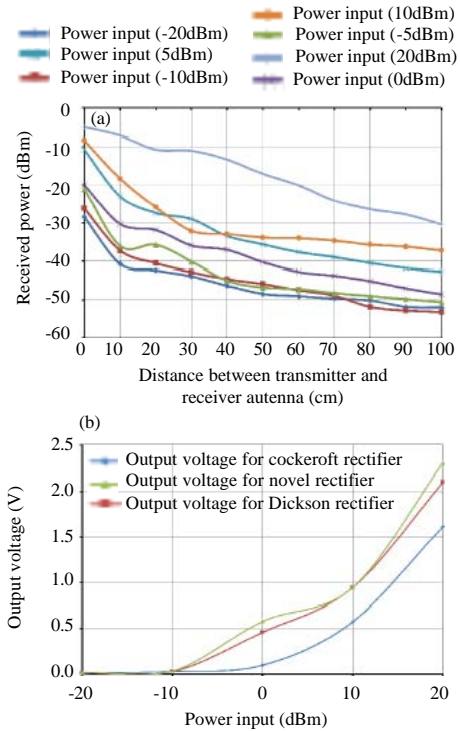

Fig. 8: a) Wireless power transmission for different input power values at 900 MHz; b) The received output voltage at 900 MHz

**CONCLUSION**

In many applications, mainly in power harvesting, it is important to design antennas with high directive characteristics to meet its demand. In this study a guideline for designing antenna has been illustrated. The design is simulated and compared for three different substrate materials using simulation. Transmission line model equations were used to design. It was clear from the results of calculations how changing the material will change the design dimensions and performance. First module was chosen to be fabricated in PCB lab. Comparing simulated and measured values for the first module indicates a good agreement between the results.

**ACKNOWLEDGEMENTS**

Resresearchrs are gratefully acknowledging the Malaysia Ministry of Higher Education (MOHE) for research approval and financial support. The research is granted by Prototype Research Grant Scheme (PRGS) of MOHE. Gratefully acknowledge Mr. Adz Jamali and Azwan from UTP for their assistance to complete this work successfully.

**REFERENCES**

- Ali, E.M., N.Z. Yahaya, N. Perumal and M.A. Zakariya, 2014. Design of RF to DC rectifier at GSM band for energy harvesting applications. *A. J. Eng. Sci. Soc.*, 10: 15-22.
- Ali, E.M., N.Z. Yahaya, N. Perumal and M.A. Zakariya, 2016. Development of cockcroft-walton voltage multiplier for RF energy harvesting applications. *J. Sci. Res. Dev.*, 3: 47-51.
- Balanis, C.A., 2016. *Antenna Theory: Analysis and Design*. John Wiley & Sons, New Jersey, USA.
- Bernard, V. and J.P. IzuchukwuIloh, 2013. Microstrip antenna design using transmission line model. *Intl. J. Emerging Technol. Adv. Eng.*, 3: 410-415.
- Choi, J.Y., 2015. Design and analysis of squared patch antenna with multi squared slots. *Indian J. Sci. Technol.*, 8: 1-4.
- Derneryd, A., 1976. Linearly polarized microstrip antennas. *IEEE. Trans. Antennas Propag.*, 24: 846-851.
- Garg, T.K., S.C. Gupta and S.S. Pattnaik, 2014. Metamaterial loaded frequency tunable electrically small planar patch antenna. *Indian J. Sci. Technol.*, 7: 1738-1743.
- Huque, M.T.I., M.K. Hosain, M.F. Samad and M.S. Alam, 2011. Design and simulation of a low-cost and high gain microstrip patch antenna arrays for the X-band applications. *Proceedings of the International Conference on Network Communication and Computer (ICNCC)*, March 19-20, 2011, IEEE, New Delhi, India, pp: 21-23.
- Johnson, R.C. and H. Jasik, 1984. *Antenna Engineering Handbook*. McGraw-Hill, New York, USA.
- Kashwan, K.R., V. Rajeshkumar, T. Gunasekaran and K.S. Kumar, 2011. Design and characterization of pin fed microstrip patch antennae. *Proceedings of the 8th International Conference on Fuzzy Systems and Knowledge Discovery (FSKD)*, July 26-28, 2011, IEEE, Salem, India, ISBN: 978-1-61284-180-9, pp: 2258-2262.
- Mezaal, Y.S., 2016. New compact microstrip patch antennas: Design and simulation results. *Indian J. Sci. Technol.*, 9: 1-6.
- Mezaal, Y.S., J.K. Ali and H.T. Eyyuboglu, 2015. Miniaturised microstrip bandpass filters based on Moore fractal geometry. *Intl. J. Electron.*, 102: 1306-1319.
- Nisha, A.S.A., 2015. Hybrid coupled feed circularly polarized patch antenna for military applications. *Indian J. Sci. Technol.*, 8: 1-4.
- Schneider, M.V., 1969. Microstrip lines for microwave integrated circuits. *Bell Labs Tech. J.*, 48: 1421-1444.
- Upadhyay, P. and R. Sharma, 2013. Design and study of inset feed square microstrip patch antenna for S-band application. *Intl. J. Appl. Innovation Eng. Manage.*, 2: 256-262.