

Performance Evaluation of OFDM Systems under PLC Fading Channel over Iraqi Grid for Variable PSK Modulation Index

Abdulkadhim A. Salman and Hadi T. Ziboon

Department of Electrical Engineering, University of Technology, Baghdad, Iraq

Abstract: There's always been a rise in demand for the service that requires huge data transmission with high transmission rates. Moreover, this demand increases exponentially which makes mandatory to implement new infrastructural setups to support this new technology in short period of time (<5 years). This makes necessary for service providers and clients to invest on new devices that support new technology. On the other hand, the power lines are very less exploited in the domain of data communication. PLC's can make use of existing infrastructure to support as a communication medium. For the case study, Iraqi power grid infrastructure is considered in this study. Thus, the power grids are exploited in this study which resembles Iraqi power grid infrastructure to perform high-speed lossless data communication using Multiple Input and Multiple Output-Orthogonal Frequency Division Multiplexing MIMO-OFDM baseband communication techniques. A comparative study is shown with multiple Phase Shift Keying (PSK) modulation indexes to support MIMO-OFDM schemes of transmission over power lines. Furthermore, to achieve higher Signal to Noise Ratio (SNR), Alamouti diversity scheme in the frequency domain is exploited as one of the MIMO configuration of communication over PLC. Thus, the effect of using MIMO-OFDM over PLC is studied and investigated in here with varying modulation index and receiver diversity (Orthogonal Space Frequency Block Coding (OSFBC) as the space frequency diversity is considered for signal modulation.

Key words: MIMO, OSFBC, PLC, OFDM-PSK, multivariate modulation, 2 port channel, infrastructure

INTRODUCTION

With recent technology, power lines are not limited to carry electricity. There are wide ranges of application including home automation, residential internet connection (also known as broadband over power line) and remote access and control of few digital appliances. With this type of setup, there is no requirement of additional infrastructure or medium to execute such mode of communication. Existing power lines with few overhead setups can be made to facilitate such communication over power lines. Moreover, power lines are in a pair of two or three which makes it possible to exploit MIMO configuration. MIMO systems employ transmission and reception scheme with multiple transmission lines (in the case of PLC). MIMO configuration of communication can either aid in achieving higher data rates (by performing simultaneous transmissions) or can aid in achieving higher Signal to Noise Ratio (SNR) performance. It is obvious that each enhancement shows trade-off with another. For example, If MIMO is schemed to be transmitting independent data simultaneously, it shows an advantage in data rate with n times or it allows n simultaneous transmissions with a trade-off in

performance over signal-to-noise. If in vice-versa, the same MIMO is used for better performance, it has a trade-off with data rates. Thus, using MIMO is advantageous in one or other way for one scheme of transmission at a time (Vishwanath *et al.*, 2003). The major obstacle that is found in power line communication is the channel fading effect (Berger *et al.*, 2014). This shall have worst effect in MIMO environment as transmission lines are used during transmission and each of these transmission lines goes under channel fading (Stuber *et al.*, 2004). The aim of this study is to study the effect of MIMO in fading channel under varying modulation index and to analyze/evaluate the enhancement of MIMO with variable Phase-Shift Keying (PSK) modulation index in fading channel of PLC over Iraqi grid (Orthogonal Space Frequency Block Coding (OSFBC) as the space frequency diversity is considered for signal modulation (Raj and Bhaskar, 2015)).

MATERIALS AND METHODS

MIMO PLC: MIMO stands for "Multiple input and multiple output" system. This means that a transmitter and receiver have more than one medium of

communication to perform the transmission. In the case of wireless communication, the assumptions hold true for multiple transmission lines and in the case of power line communication, multiple power lines hold true for MIMO assumption. Having more than one transmission line can be advantages either to increase data rate or to increase efficiency. Multiple approaches can be used in MIMO system depending upon the channel environment of wireless communication (Paulraj *et al.*, 2004).

Overview: Figure 1 show different multi-transmission line (or antennas) schemes of transmission. First one is the SISO which is single input single output format. This means that T_x have only one transmission line and R_x have only one transmission line for transmission. Another is single input multiple output SIMO where T_x has only one transmission line while R_x has multiple transmission lines. Alamouti coding scheme must be defined before transmitting from the type of configuration. But in general, multiple R_x transmission lines receive the same information and thus redundancy is achieved. This redundancy is called as diversity in the space domain. Thus, ultimately it helps in efficiency, over noise margin and gains over higher SNR.

Next configuration is MISO which is the reverse of SIMO where transmitter T_x has multiple transmission lines and Receiver R_x has a single transmission line. Again, predefined Alamouti codes must be used for efficient transmission. Next and final configuration is the MIMO where T_x has multiple transmission lines and R_x has multiple transmission lines. Thus, it can be used either for increasing efficiency of transmission over the noisy environment or can be used for increasing data rates using parallel transmission. Again, if it used for diversity, Alamouti coding scheme must be used accordingly.

Figure 2 shows channel structure or channel matrices for MIMO scheme of transmission (Berger *et al.*, 2015). Where h represents complex channel parameter with suffixed path. For example, h_{21} is the path gain of channel path from T_x transmission line number 1 to the R_x transmission line number 2. Thus, complete path gains can be represented by Matrix H with the size of $nT \times nR$. Received signal can be given by:

$$Y = N + H_x X \tag{1}$$

Where:

Y = A matrix $nT \times nR$

N = The additive white Gaussian Noise w.r.t to SNR

H = The matrix of channel path gain

X = The transmit signal in form of block codes

OSFBC: Space Frequency Block Coding (SFBC) is a technique used in wireless communications to transmit multiple copies of a data stream across several

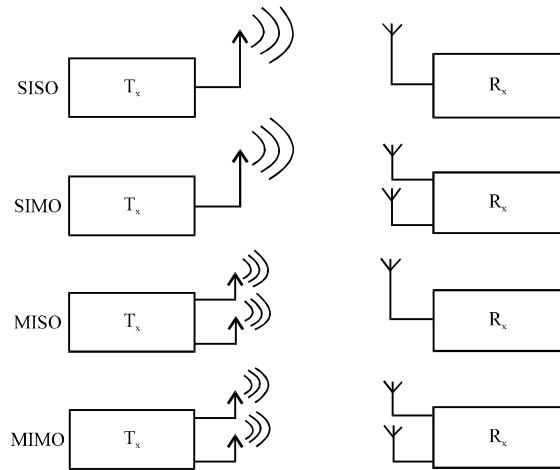

Fig. 1: Comparing MIMO with SISO, SIMO and MISO

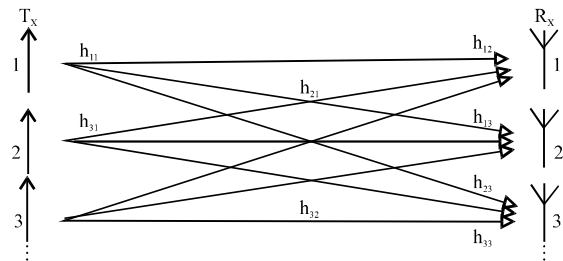

Fig. 2: Channel modelling

transmission lines and to exploit the various received versions of the data to improve the reliability of data transfer. Here, SFBC as Space-Frequency Block Coding is used (Torabi *et al.*, 2014). The given matrix gives the only way to achieve orthogonality. SFBC is designed such that the vectors represent any pair of columns taken from the coding matrix is orthogonal. The estimation of the signal is simple, linear and optimal decoding is used at the receiver. The advantage of using space frequency diversity is to improve performance with respect to SNR with a trade-off in data rate. The trade-off is in a sense that data rate is maintained to SISO system. Special Alamouti coding scheme is used in case of diversity. Alamouti defined the special method of transmission for exploiting diversity in MIMO system.

Channel consideration

Noise modeling: AWGN (Gesbert *et al.*, 2002) stands for additive white gaussian noise. It basically adds white Gaussian Noise to the transmitting signal. While talking particularly about MIMO, SNR may remain same during transmission but the critical value of noise may vary. This means that variance remains same but not exact complex noise. The channel’s amplitude frequency response is flat and phase frequency response is linear for all frequencies,

so that, modulated signals pass through it without any amplitude loss and phase distortion of frequency components. Fading does not exist but the only distortion is introduced by the AWGN (Gesbert *et al.*, 2002). The received signal is simplified to:

$$r(t) = x(t) + n(t) \quad (2)$$

where, $n(t)$ is the additive gaussian noise. The relationship between E_s/N_0 and E_b/N_0 both expressed in dB is as follows (Gesbert *et al.*, 2002):

$$E_s/N_0 \text{ (dB)} = E_b/N_0 \text{ (dB)} + 10 \log_{10}(k) \quad (3)$$

where, k is the number of information bits per symbol. The relationship between E_s/N_0 and SNR both expressed in dB for complex input signals is as follows (Gesbert *et al.*, 2002):

$$E_s/N_0 \text{ (dB)} = 10 \log_{10}(T_{sym}/T_{samp} + \text{SNR (dB)}) \quad (4)$$

and for real input signals is:

$$E_s/N_0 \text{ (dB)} = 10 \log_{10}\left(\frac{1}{2} T_{sym}/T_{samp}\right) + \text{SNR (dB)} \quad (5)$$

Where:

T_{sym} = The signal's symbol period

T_{samp} = The signal's sampling period

2-port model: Demonstrating and describing the distinctive properties of a given correspondence channel is one of the essential and vital properties to be done before transmitting data over the channel. Such examinations help to comprehend the conceivable areas of the exchange work, the drive reaction, symmetry and so, forth of the channel under various possible situations to which the channel might be subjected amid the genuine information transmission (Korki *et al.*, 2011). The PLC channel can be displayed as a multi-way channel and can be communicated regarding the weighting Coefficients, weakening coefficients and defer parameters. The PLC channel can likewise be demonstrated as any two-port channel through ABCD parameters dealing with expanding parameters in the displaying (Choi and Murch, 2004).

As it has already been presented in (Unsal and Yalcinoz, 2015) the relation between the sending-end quantities (V_1 and I_1) and receiving-end quantities (V_2 and I_2), Fig. 3 using the ABCD matrix is written as:

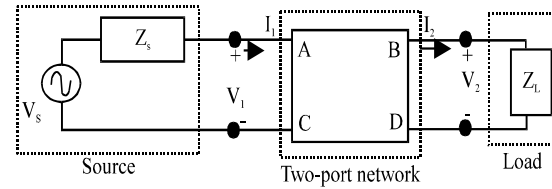

Fig. 3: Transmission matrix of a two-port network

$$\begin{bmatrix} V_1 \\ I_1 \end{bmatrix} = \begin{bmatrix} A & B \\ C & D \end{bmatrix} \begin{bmatrix} V_2 \\ I_2 \end{bmatrix} = \begin{bmatrix} \cosh(\gamma l) & Z_c \sinh(\gamma l) \\ \frac{1}{Z_c} \sinh(\gamma l) & \cosh(\gamma l) \end{bmatrix} \begin{bmatrix} V_2 \\ I_2 \end{bmatrix} \quad (6)$$

where, l is the length of the transmission line (Unsal and Yalcinoz, 2015). The transfer function of a simple power line model shown in Fig. 4 is given by:

In any case, control line systems, especially dissemination systems are not for the most part as straightforward as the one delineated in Fig. 3. They, as a rule, comprise of scaffold taps with various link lengths and link sorts to shape an electrical overhead line system made of a few areas. For an electrical overhead line system with a few areas, the exchange capacity is again figured; be that as it may, the ABCD grid can be registered by increasing the ABCD lattices for the diverse segments of the system to acquire the general ABCD framework (Choi and Murch, 2004).

Summary: As the PLC is the base medium of communication, PSK modulation is selected for the signal. It is not compulsory to use PSK modulation, many researchers have considered using QAM instead of PSK (Mlynek *et al.*, 2011; Razazian *et al.*, 2010). There reason assumed here is that, for a power line there is fixed phase shift in the powerline with varying amplitude of AC. Thus, choosing PSK modulation would be less prone to errors as no information will be shared in amplitude that vary with time and phase would help in hard limiting demodulation (Nassar *et al.*, 2012; Kim *et al.*, 2010). Moreover, PLC channel is more prone to interference and noises that results in intensive degradation of the signal. Many researchers have proposed using QFDM-PSK modulation instead of PSK modulation to exploit the anti-interference properties of the OFDM (Mlynek *et al.*, 2011; Zhang and Meng, 2010). Considering these reference, we assume that QFDM-PSK modulation is superior to PSK modulation for PLC and we proceed further with the simulation along with this assumption. The role of Iraqi grid is to simulate the transmission line

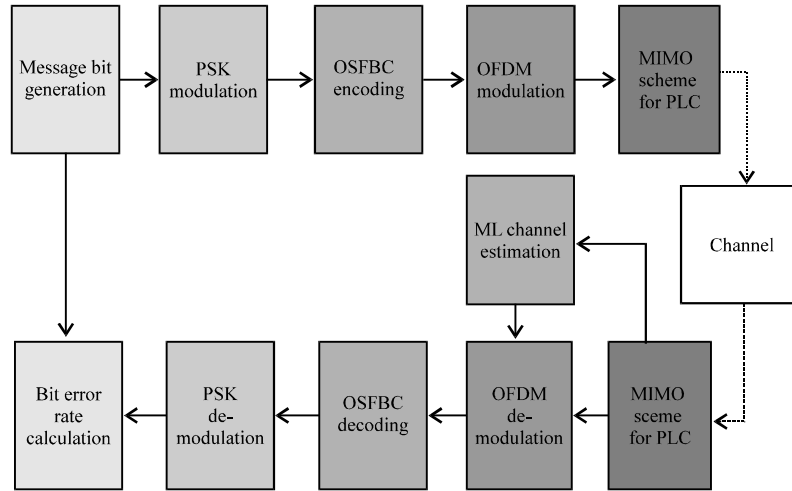

Fig. 4: System block diagram

properties to actual grid ratings in Iraq that includes bandwidth, operating voltage, resistance, inductance, capacitance, etc. Typical PLC contains combination of various noise including corona noise, colored noise, impulse noise and gaussian noise with additive in nature. Along with noise, attenuation, standing waves, signal reflection and other such types of channel properties as standard are considered while simulating the channel as given by Cort.

RESULTS AND DISCUSSION

Simulation

system model: Figure 4 shows the system block diagram that was used to develop MATLAB simulation. Here, original message symbols in digital form were generated using random function. Based on the modulation index number, the order of modulation in PSK was determined and message bits are modulated with respective modulation index. Once the message bits are modulated, they are required to be blocked as per the decided MIMO transmission scheme. Here, OSFBC is considered for demonstration and thus, Alamouti coding scheme in frequency and space domain is exploited. The message symbols are arranged in such a form that they exhibit orthogonally between the transmitted data at same time slots through different transmission lines. Thus, two different symbols are transmitted in two frequency band with two different transmission line simultaneously (reference model 2×2) (Kermaal *et al.*, 2002). At the reception, the channel is required to be estimated for a case during simulation, the channel is assumed to be estimated using Maximum Likelihood (ML) detection technique. It can be considered that, once the channel is estimated, original transmitted signal is recovered. The

recovered signal is decoded using OSFBC technique and average of multiple symbols received from transmission line at time t , frequency diversity is considered for further manipulation. This signal is then demodulation with respective modulation index and original message bits are recovered. To calculated bit error rate, original and recovered message bits are compared bitwise and a graph is plotted with respect to given signal to noise ratio.

As the medium of communication is power lines, the proposed system utilizes two power lines. The two power lines are coupled to a digital transmitter which introduces digitally modulated data. Similarly, at the end of the power line, a digital splitter splits receiver transmission lines to support spatial diversity. As the baseband modulation is OFDM, each of the subcarrier frequencies are orthogonal to each other. Thus, a band-limited filter is assumed to be used that can split the power line to two transmission recipient lines individually at receiver for digital data. This enables various communication configurations ranging from $2 T_x$ to $1 R_x$, $2 R_x$, $3 R_x$ and $4 R_x$ respectively with spatial diversity scheme as shown in Fig. 5. Here, the spatial means transmission lines and diversity is exploited in the same pattern to OSTBC but in frequency bands, make the configuration as OSFBC.

Simulation parameters

Simulation results: Figure 6 shows simulation result from Matlab code with two transmits transmission lines and 1-3 (split from line 1) and 4 (split from line 2) receive transmission lines. Here, QPSK modulation scheme is used for transmission. It can be seen from the graph that an increasing number of receives transmission lines shows increment in performance with respect to SNR. Moreover, if the gain difference is considered between one receive transmission line and two receive

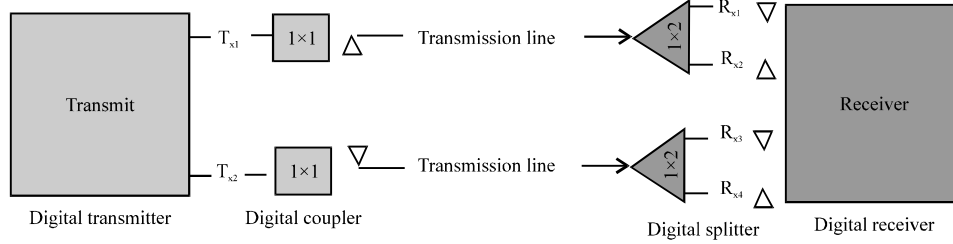

Fig. 5: Power line scheme for spatial diversity

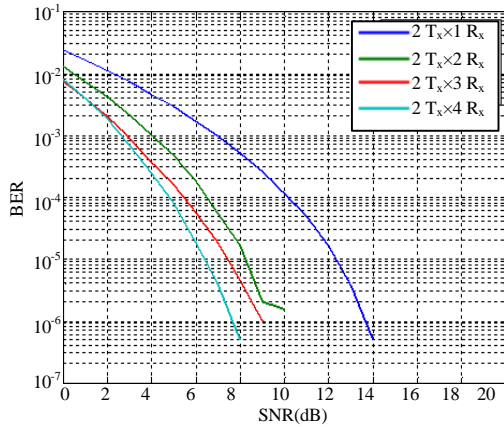

Fig. 6: QPSK MIMO

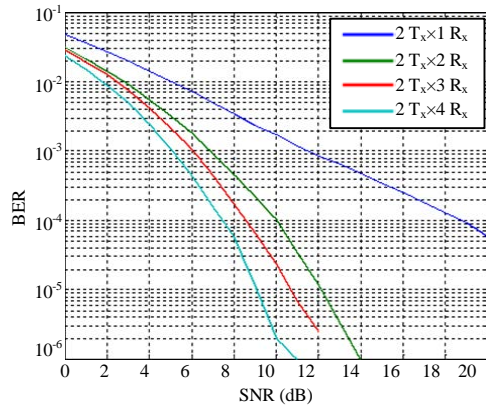

Fig. 7: 8-PSK MIMO

transmission line, there is a gain advantage of 4 dB but between 2-4 receive transmission line, there is a gain advantage of only 2 dB at 10^{-5} BER (Table 1).

Figure 7 shows MATLAB simulation results for 8-PSK with different receive transmission lines. Again, a common result is noticed that increasing receive transmission line shows an advantage in performance over SNR. Similarly, between one receive transmission line and two receive transmission line there is much gain advantage of about 12 dB but between two to four, there is the advantage of 4 dB which is much less compared to 12 dB gain at 10^{-5} BER.

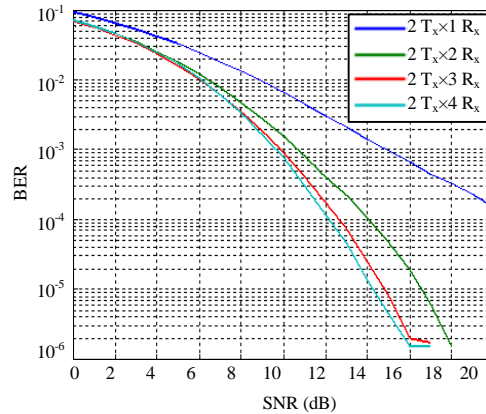

Fig. 8: 16-PSK MIMO

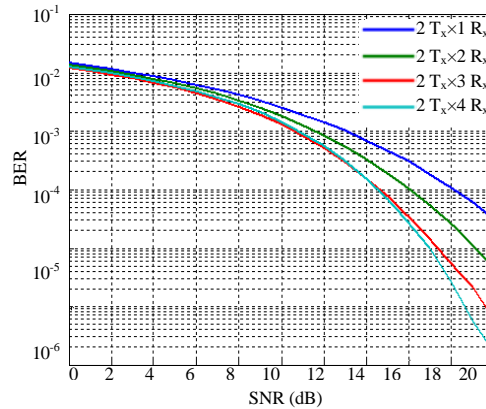

Fig. 9: 32-PSK MIMO

Figure 8 shows, MATLAB simulation result for 16 PSK MIMO system. Here, the modulation is increased to 16 which increases in spatial efficiency. The results obtained drives same conclusion to the previous one about the increase in R_x transmission lines.

Figure 9 shows a similar result for MATLAB simulation for 32 PSK. Result convey same information about the increase in receive transmission line. Here, the graph is plotted up to 20 dBs only because transmission later than that cannot be used for transmission as per ITU grid.

Table 1: Simulation parameters

Parameters	Values
Modulation type	OFDM-PSK
Modulation order	4, 8, 16, 32
Channel type	2 Port PLC with memory (Zhai and Su, 2014)
Number of symbols	106
Tx transmission line	2
Rx transmission line	1, 2, 3, 4 (Multiplexed)
Coding	OSFBC
Base band transmission	OFDM 64 bit
Bandwidth	500 Hz
Line voltage	400-kV
Resistance of overhead line	0.097/ksm
Inductance of overhead line	0.387/km
Susceptance of overhead line	2.97/km

Evaluation: The increase in receive transmission line certainly increases the performance adhering the trade-off with data rate. To increase receive transmission line, transmission matrices is modified which increases with respect to several transmitting and receive transmission lines. Thus, in other words to increase the number of receive transmission line, apart from transmission line hardware cost, more frequency slots are introduced in form of diversity. Thus, ultimately increasing R_x transmission line will increase times of transmission. With the increase in times of transmission, the data rate is severely affected. Along with data rate, transmission cost is increased to the increased number in transmission. Transmission cost considers various costs like spectrum usage cost, active RF power supply cost and many others. Thus, increase in R_x transmission line shows benefit in performance but with trade off in transmission cost and data rate. The result that is obtained from above simulation states that there is vast performance gain between 1 R_x transmission line and 2 R_x transmission line, but there is not much difference between 2 R_x transmission line to 4 R_x transmission line. Which means that using MIMO is better than MISO but increasing R_x transmission line in existing MIMO (i.e., more than 2 R_x transmission lines) with the cost of additional transmission and data rate is not beneficial. Thus, if existing power line infrastructure supports only two lines, adding more carrier lines will not be beneficial compared to the cost of enhancement.

Another, result that is observed from this simulation is that with an increase in modulation index there is an increase in spectral efficiency or in another way, more bits of the message are sent at a time which ultimately increases the end-to-end data rate (Here, end-to-end data rate is considered which must not be confused with the transmission data rate. However, transmission data rate remains constant as per the channel specification considering Shannon channel capacity theorem (Sharif and Hassibi, 2005). End-to-end data rate means effective data rate that can be calculated by several original

unmodulated message bits in given time while transmission data rate is the rate of transmission over any channel (Choi and Murch, 2004). However, combining all the above simulation results, it shows that with an increase in modulation index, there is decay in performance which holds relation with a probability of error theorem including the space between the points in scatterplot and boundary conditions. Increasing modulation index will decrease space between the points in a scatterplot and will increase the errors in detection (Vishwanath *et al.*, 2003). Thus, an optimum decision in deciding modulation index is further to be proposed aids in achieving target performance.

CONCLUSION

The comparative study shows that using MIMO is beneficial over MISO to improve the system performance and the communication capacity of a wired and wireless communication but if number of receive transmission lines is maintained to the number of transmitting transmission line, it shows optimal transmission considering performance of transmission, cost of transmission and data rate of transmission. Further, increase in receive transmission line shows an advantage in reception performance but is not recommended considering the performance obtained with the cost of transmission and loss of data rate. In actual, Iraqi transmission lines contains only two parallel lines of transmission. The comparative study shows that optimized MIMO can be achieved with existing infrastructure of Iraqi Transmission lines (2x2) without any further requirement of physical modification to infrastructure (Here, end-to-end data rate is considered which must not be confused with the transmission data rate. However, transmission data rate remains constant as per the channel specification considering Shannon channel capacity theorem (Sharif and Hassibi, 2005).

Increasing modulation index shows an advantage in spectral efficiency and helps in increasing effective end-to-end data rate but with loss over performance. Thus, an optimal value of modulation index must be selected based on the performance required over given SNR. As a bottom line, PLC with recommended configuration can be used for data communication without any additional change in the infrastructure considering Iraqi power grid as the case study to support the applications like telephone (analog), telephone (voip), fax, remote terminal unit, internet, video surveillance, projection relay and modem communication. The space frequency diversity help in regulating the BER performance over the SNR which must be selected based on the target application.

REFERENCES

- Berger, L.T., A. Schwager, P. Pagani and D. Schneider, 2014. MIMO Power Line Communications: Narrow and Broadband Standards, EMC and Advanced Processing. CRC Press, Boca Raton, Florida, USA., ISBN-13:978-1-4665-5752-9, Pages: 690.
- Berger, L.T., A. Schwager, P. Pagani and D.M. Schneider, 2015. MIMO power line communications. IEEE. Commun. Surv. Tutorials, 17: 106-124.
- Choi, L.U. and R.D. Murch, 2004. A transmit preprocessing technique for multiuser MIMO systems using a decomposition approach. IEEE. Trans. Wireless Commun., 3: 20-24.
- Gesbert, D., H. Bolcskei, D.A. Gore and A.J. Paulraj, 2002. Outdoor MIMO wireless channels: Models and performance prediction. IEEE. Trans. Commun., 50: 1926-1934.
- Goldsmith, A., S.A. Jafar, N. Jindal and S. Vishwanath, 2003. Capacity limits of MIMO channels. IEEE J. Sel. Areas Commun., 21: 684-702.
- Kermoal, J.P., L. Schumacher, K.I. Pedersen, P.E. Mogensen and F. Frederiksen, 2002. A stochastic MIMO radio channel model with experimental validation. IEEE. J. Sel. Areas Commun., 20: 1211-1226.
- Kim, I., B. Varadarajan and A. Dabak, 2010. Performance analysis and enhancements of narrowband OFDM powerline communication systems. Proceedings of the 1st IEEE International Conference on Smart Grid Communications, October 4-6, 2010, Gaithersburg, MD., USA., pp: 362-367.
- Korki, M., N. Hosseinzadeh, H.L. Vu, T. Moazzeni and C.H. Oh, 2011. A channel model for power line communication in the smart grid. Proceedings of the Conference on Power Systems and Exposition (PSCE), March 20-23, 2011, IEEE, Phoenix, Arizona, USA., ISBN:978-1-61284-789-4, pp: 1-7.
- Li, J. and P. Stoica, 2009. MIMO Radar Signal Processing. John Wiley & Sons, Hoboken, New Jersey, USA., ISBN:9780470178980, Pages: 448.
- Mlynek, P., J. Misurec, M. Koutny and M. Orgon, 2011. Power line cable transfer function for modelling of power line communication system. J. Electrical Eng., 62: 104-108.
- Nassar, M., J. Lin, Y. Mortazavi, A. Dabak and I.H. Kim *et al.*, 2012. Local utility power line communications in the 3-500 KHz band: Channel impairments, noise and standards. IEEE. Signal Process. Mag., 29: 116-127.
- Paulraj, A.J., D. Gore, R.U. Nabar and H. Bolcskei, 2004. An overview of MIMO communications-a key to gigabit wireless. Proc. IEEE, 92: 198-218.
- Raj, U. and V. Bhaskar, 2015. Performance analysis of SNR based scheduling scheme for MIMO OSFBC-OFDM systems in α - μ fading channels. Intl. J. Wireless Inf. Networks, 22: 147-156.
- Razazian, K., M. Umari, A. Kamalizad, V. Loginov and M. Navid, 2010. G3-PLC specification for powerline communication: Overview, system simulation and field trial results. Proceedings of the IEEE International Symposium on Power Line Communications and its Applications, March 28-31, 2010, Rio de Janeiro, Brazil, pp: 313-318.
- Sharif, M. and B. Hassibi, 2005. On the capacity of MIMO broadcast channels with partial side information. IEEE. Trans. Inform. Theory, 51: 506-522.
- Stuber, G.L., J.R. Barry, S.W. McLaughlin, Y. Li, M.A. Ingram and T.G. Pratt, 2004. Broadband MIMO-OFDM wireless communications. Proc. IEEE, 92: 271-294.
- Torabi, M., A. Jemmali and J. Conan, 2014. Analysis of the performance for SFBC-OFDM and FSTD-OFDM schemes in LTE systems over MIMO fading channels. Intl. J. Adv. Networks Serv., 7: 1-11.
- Unsal, D.B. and T. Yalçinoz, 2015. Applications of new power line communication model for smart grids. Intl. J. Comput. Electrical Eng., 7: 168-178.
- Unsal, D.B. and T. Yalçinoz, 2015. Applications of new power line communication model for smart grids. Intl. J. Comput. Electrical Eng., 7: 168-178.
- Vishwanath, S., N. Jindal and A. Goldsmith, 2003. Duality, achievable rates and sum-rate capacity of Gaussian MIMO broadcast channels. IEEE. Trans. Inf. Theory, 49: 2658-2668.
- Zhai, M.Y. and L.D. Su, 2015. Research on the memory order of the power-line communication channel. Intl. J. Commun. Syst., 28: 1068-1079.
- Zhang, J. and J. Meng, 2010. Noise resistant OFDM for power-line communication systems. IEEE. Trans. Power Delivery, 25: 693-701.