

## Interfacing of GPS and GPRS Modules to the Beagleboard for Driver Assistance System

H. Bharathi, K. Durga Sowjanya and Mahendra Vucha  
Department of Electronics and Communication Engineering,  
MLR Institute of Technology, Hyderabad, India

---

**Abstract:** This study presents a design model for position based driver assistance systems to locate the position of the vehicles using GPS-GPRS based vehicle tracking system. The GPS tracking system of smart phone can give assistance to the driver while travelling. The GPRS technology is used to send the position of the vehicle as a SMS to the owner of the vehicle. It is used to provide security to the vehicle and driver, so, there is no needed emergency at the place in proposed method. This study focuses on tracking the position of the vehicle and sends SMS to the destination/registered mobile number through wireless technology. This system is used to provide GPS and GPRS modules interfaced with the beagle board into the vehicle. The embedded operating system angstrom is used to implement the proposed system. The processor used in the beagle board for development of device drivers of GPS and GPRS is OMAP 3530 processor. Standard Linux kernel and open CV package are used to interface GPS and GPRS modules to the driver assistance system.

**Key words:** GPS (Global Positioning System), GPRS, Beagle board, open CV package, OMAP 3530 processor, SMS

---

### INTRODUCTION

Nowadays, we are focused on arriving at our destination as quickly as possible. Vehicle manufacturers are focused on passive approach like airbags, seat belts and antilock brakes, lane departure warning system and collision avoidance systems. But, we are not always aware of the dangerous conditions that we experienced while operating an automobile.

There are many technologies are available in the market for detection of the car thefts and location of the cars. In earlier days, many cars were theft and they can't recover the stolen car. These are the main drawbacks of these systems in securing the cars and they do not assist owners in recovering a stolen car, they do not let owner communicate with its car online even if his car has been stolen and the user cannot find out the current status of his car when his car is being used by some other third party.

The proposed security system in this study is integration of GPS that is used in location tracking and GPRS is used for the modern communication technology. SMS is the easiest way used widely for communication purposes because of in expensive, convenient and messages can be transmitted and received with high reliability. Combination of GPS and GPRS technologies it

provides effective, real time vehicle location and reports the status of the car to the owners. By sending an SMS to owners they let know where the vehicle is presently where it was and how long it was present there using GPS (Shah *et al.*, 2014; Bhilare *et al.*, 2015).

**GPRS and GPS technology:** The GPRS (General Packet Radio Service) is adds some nodes in the network to provide the packet switched services. GPRS operates on existing GSM network that it utilizes available time slots during each frame transmission. Thus, it does not overload network traffic and can efficiently provide data services. The GPRS can transfer data at the maximum rate of 115.2 Kbps. Due to large coverage area of GSM around the world, GPRS becomes the largest data service network available and is most suitable for a real-time tracking management system. It does not overload the network traffic and can efficiently provide data services (Ranganath *et al.*, 2011).

These network nodes are called as GPRS nodes and are responsible for the routing and delivery of data packets to and from the mobile station. It provides e-Mail and web browser in addition to short message service and circuit switched data for fax transmission for the information dispersion. Figure 1 shows the architecture of the GPRS system.

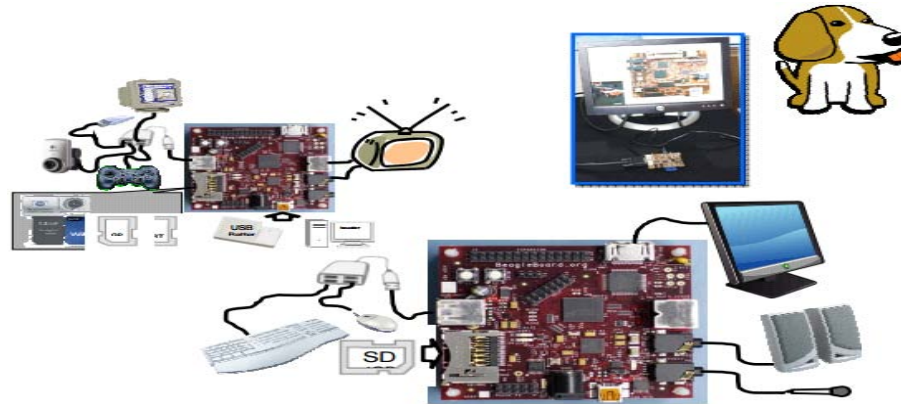

Fig. 1: Beagle board usage scenarios

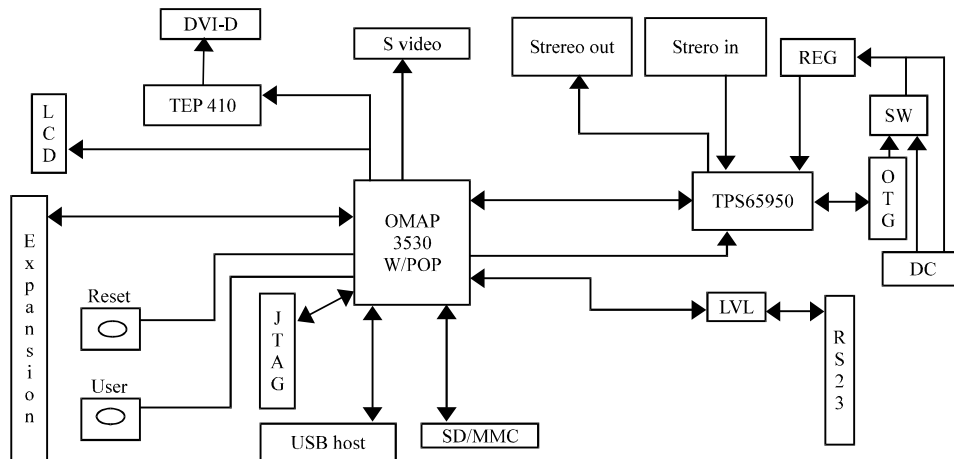

Fig. 2: Beagle board high level block diagram

Global positioning system is a system composed of a network of 24 satellites. These satellites periodically emit radio signals as short pulses to GPS receivers. A GPS receiver receives the signal from at least three satellites to calculate distance with the use of triangulation technique to compute its latitude and longitude positions. Once a location is computed, it calculates an average speed and direction of travelling vehicle.

**Beagle board:** The Beagle board is an OMAP 3530 platform specifically designed to address the open source community. Figure 1 shows a few of the various usage scenarios of the beagle board. Its features are to allow the user to experience the power of the OMAP 3530 by utilizing standard interfaces, the beagle board is highly extensible to add many features and interfaces.

Beagle board high level diagram is shown in Fig. 2. The high level block diagram consist of OMAP 3530 processor with S-video connector, DVI-D connector,

Stereo. In and out connector, HS USB host port, SD/MMC connector, JTAG, LCD, expansion pins, reset and user buttons.

**OMAP processor:** The beagle board uses the OMAP 3530 DCBB 72720 MHz version and comes in a 4 mm pitch POP package. POP (Package on Package) is a technique where the memory, NAND and SDRAM are mounted on top of the OMAP 3530. The location of key components on the beagle board is given in Fig. 3.

The heart of beagle board is OMAP 3530 processor. high level block diagram of the OMAP 3530 is shown in Fig. 4. It consists of DSS interface, SD/MMC interface, USB OTG interface, NTSC/PAL/S-Video output, power management, serial interface, I2C interface and I2S audio interface (McBSP2). Expansion McBSP1 and JTAG debugging interface.

**Literature review:** There has been significant research work in these areas in past decade. Most of these related

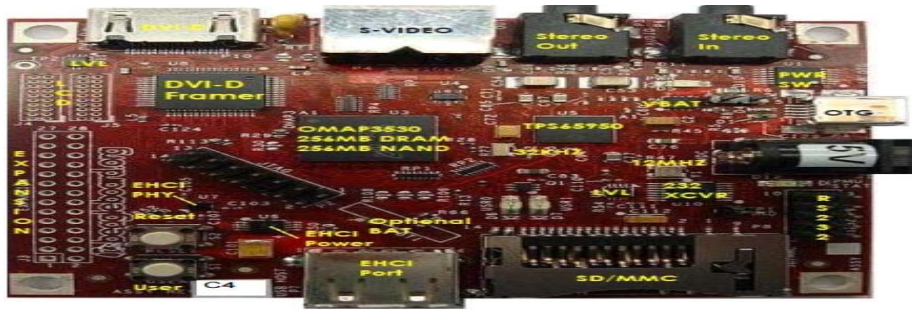

Fig. 3: The location of key components on the Beagle board

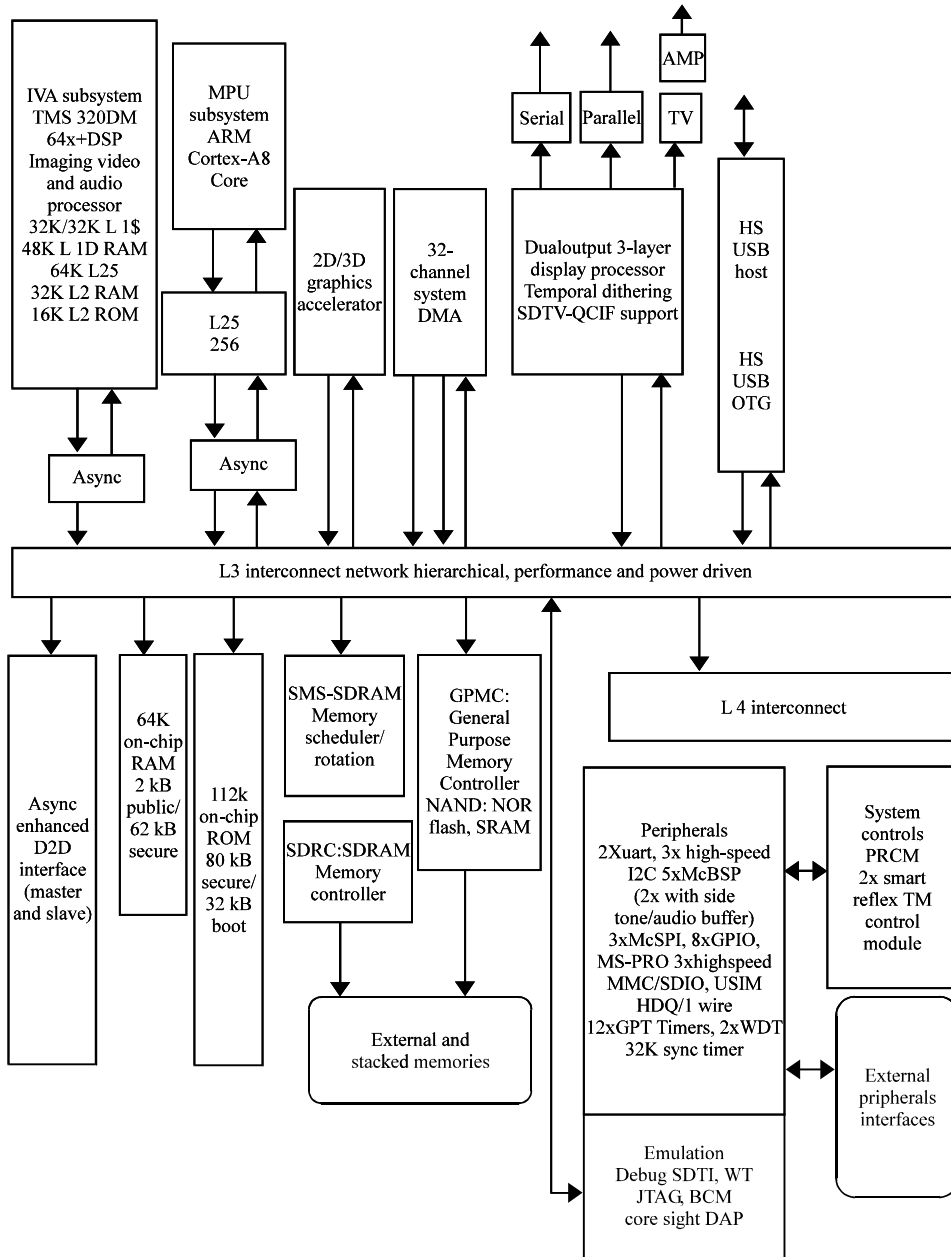

Fig. 4: OMAP 3530 block diagram

to interface the modules to the beagle board (Krishnasree *et al.*, 2014). Ravi and Srujana (2015) proposed the GPS/GSM based system which integrate both GSM and GPS technologies. It is used in many of applications of both GSM and GPS systems because of the wide usage by millions of people throughout the world. Mamatha and Aravind (2015) discusses a vehicle to vehicle location-based broadcast communication protocol in which each vehicle generates emergency messages at a constant rate. Message forwarding service can helps the vehicles to reach warning message beyond the radio transmission range. They propose a multi-hop broadcast protocol based on slot reservation MAC. The system proposed by Boopathi *et al.* (2014) describes the motion properties of vehicles used to help with message relay.

Albert and Ezhilarasie (2011) proposed a system that uses sensors to monitor the fuel level, driver conditions and speed of the vehicle. This data is transferred to cloud server-using GSM enabled device. The vehicle equipped with GPS antenna locates the place. To avoid the drunk and drive, the alcohol sensor installed in the system to monitor the driver status. The proposed system by Albert and Ezhilarasie (2011) significantly avoids the accident in highways.

Different collision avoidance systems have been proposed by Ranganath *et al.* (2011), Albert and Ezhilarasie (2011) and Shah *et al.* (2014). The application of GPS card for navigational system by infrared control of the cars is used in foggy condition to avoid accident along with micro central system (Albert and Ezhilarasie, 2011). The proposed system by Boopathi *et al.* (2014) describes the road accident patterns with drowsy/sleepy drivers. It proposes the architecture for integrating intelligent control systems into vehicles with special consideration to include the human driver in the control loop. Proposes driver assistance system and (Singh *et al.*, 2012) proposes sound source guidance system. Nowaday's people are getting more and more conscious and secure with the support of wireless communication technologies to monitor a vehicle performance. The system proposed by Yalic *et al.* (2013) uses various wireless technologies for traffic safety.

The system by Ravi and Srujana (2015) and Boopathi *et al.* (2014) proposes a method which uses ARM processor that sends the alert message including the location of the vehicle through the GPRS modem to police control room or a rescue team if there is any accident occurs.

Thakor *et al.* describes a real-time online safety prototype that controls the vehicle speed under driver

fatigue that detects fatigue symptoms in drivers and control the speed of vehicle to avoid accidents (Ranganath *et al.*, 2011).

## MATERIALS AND METHODS

**Proposed system architecture:** The front-end of the system consists of satellite receiver, GPS module, main control module and GPRS module. The block diagram of the proposed system is shown in Fig. 5. It shows the flow of events during implementation. The beagle board with two serial ports is interfaced to the microcontroller of the main control module to provide the communication between GPS module and GPRS module and G20 in GPRS module has complete function of TCP/IP protocol. GPRMC data format in NMEA-0183 is used for GPS output data in this system.

The GPRS module used in the front-end is communicates with the database server with the support of internet. In order to receive and transmit the information, the IP address of the database server is used to generate the warning information and send it to the frontend portable equipment. MYSQL is used in the database server of the back-end monitoring center and the GPS data is stored in MYSQL database.

**Kernel configuration:** The Version 2.6.32 is used in kernel configuration. The simplest and fastest way to mofidy the default configuration is via. the following command # make menucon (Fig. 2). Then a graphical user window and setup is explained in Fig. 6. Select general setup and click on select key.

**Configuring supported device drivers:** To operate the board with SD card and I/O devices, device drivers should be configured. To interface with SD card and I/Oo devices, device driver support is used. The device driver

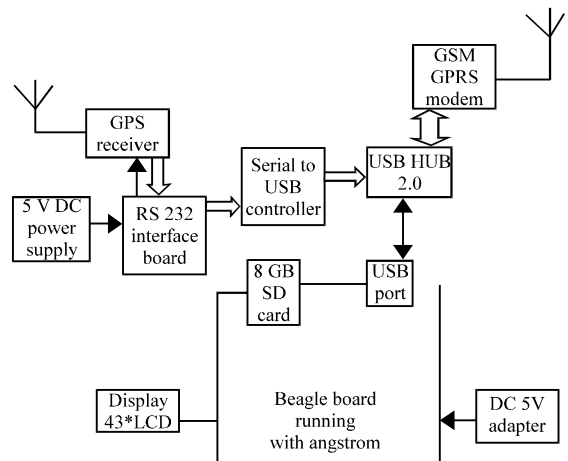

Fig. 5: Block diagram of driver assistance system

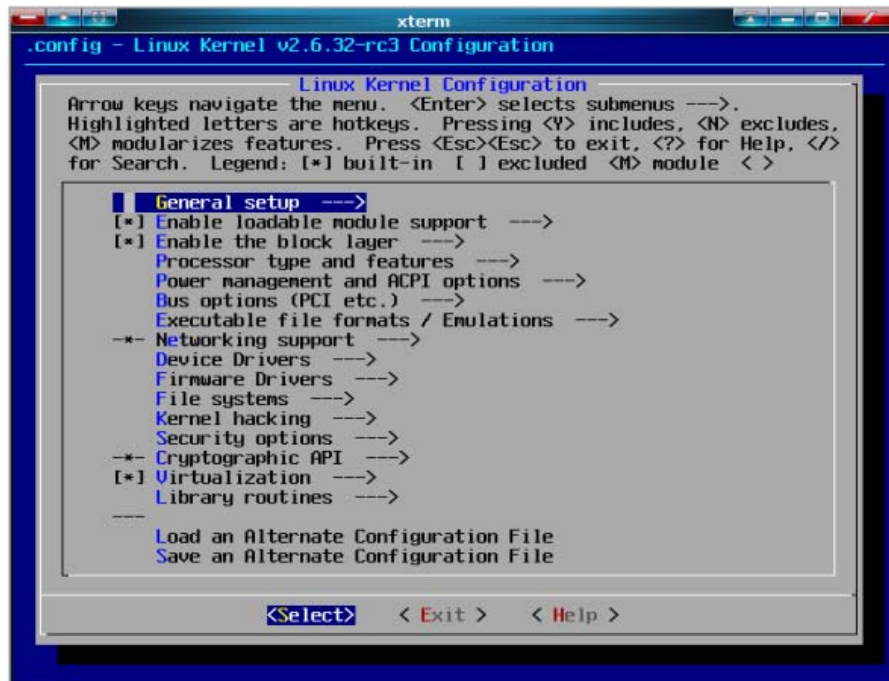

Fig. 6: Kernel configuration setup

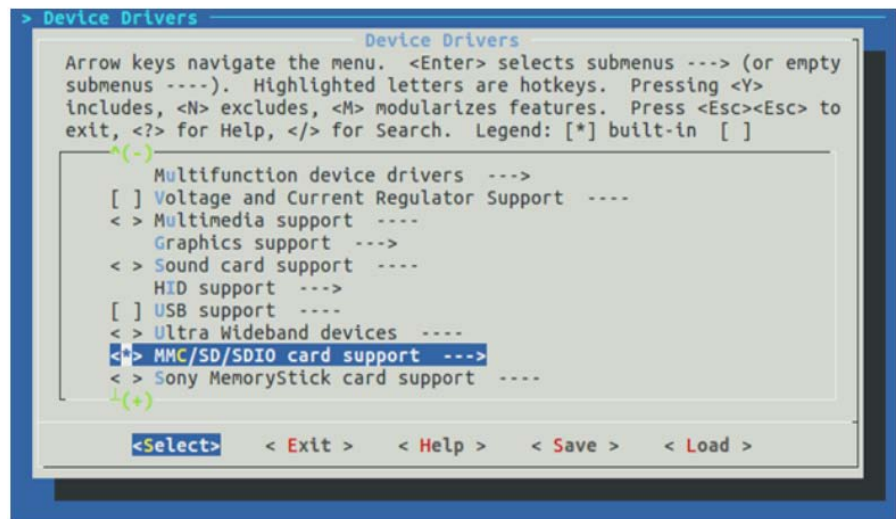

Fig. 7: MMC/SD/SDIO card support setup

configuration is shown in Fig. 7. Use the down key and select device driver option. Then select MMC/SD/SDIO card support [\*] and click on select. Then the device drivers for sound cards are installed.

- File systems ---> [\*]
- DOS/FAT/NT File systems (CONFIG\_FAT\_FS)
- <\*> MSDOS fs support (CONFIG\_MSDFS)
- <\*> VFAT (Windows-95 fs support)
- (CONFIG-VFAT-FS)

**File system:** The file system is the most basic level of organization in kernel configuration. The configuration of file system is shown in Fig. 8. For enable the file system, use the following commands:

Serial to USB converter cable support driver: For interfacing the board to various serial devices, we need serial to USB converter cable support driver. To enable these drivers the following commands are to be used.

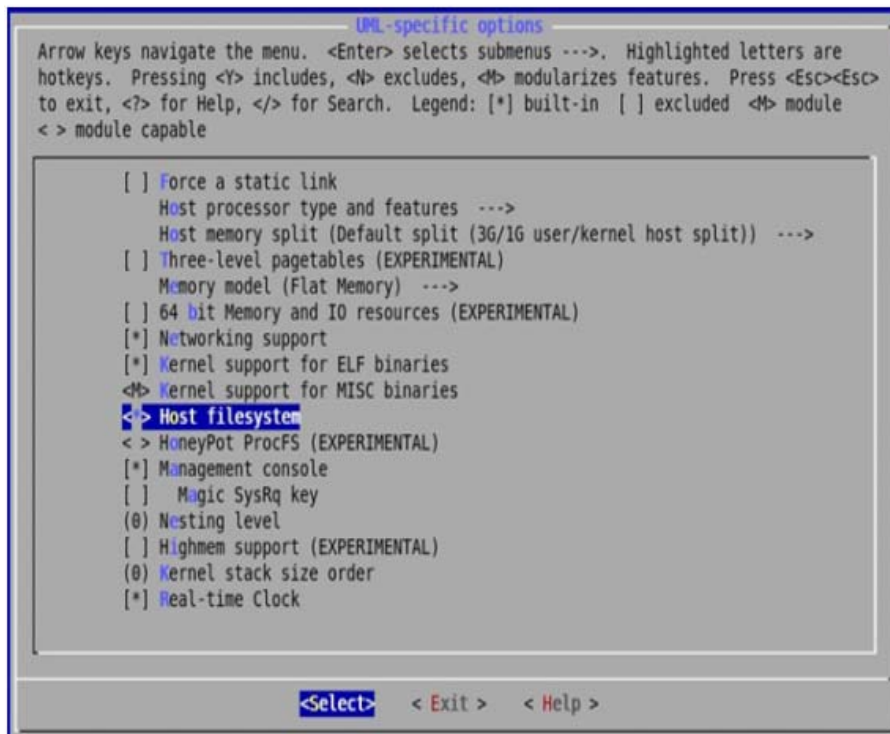

Fig. 8: File system configuration setup



Fig. 9: USB to serial port converter support setup

- Device driver
- USB support
- USB to SERIAL converter support
- USB prolific 2303 single port serial driver

**GPS Garmin driver:** The device drivers for GPS receiver are enabled as follows:

- Device driver
- USB support
- USB to SERIAL converter support
- USB Garmin GPS driver

Then user interface window of enabling USB to serial port converter cable support is shown in Fig. 9.



Fig. 10: USB Garmin GPS device setup

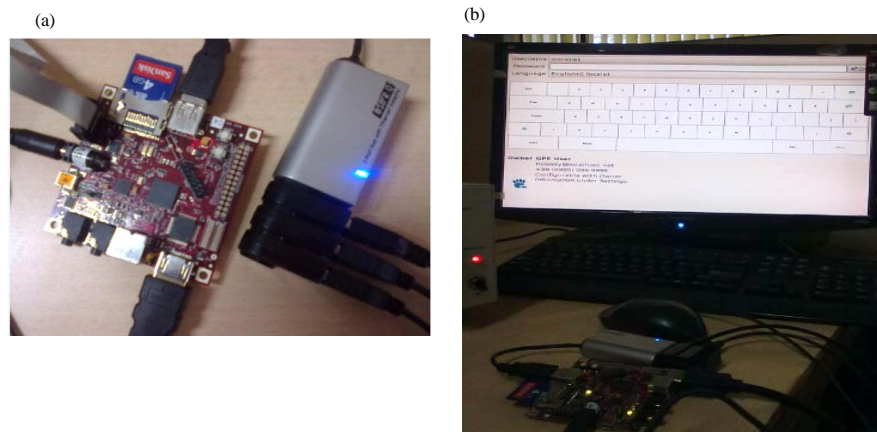

Fig. 11: a) Beagle board with connections and SD card and b) Log-in window on DVI-monitor after porting OS on to the Beagle board

Then the GPS device setup as shown in Fig. 10 is appeared. Enter the required data and click on ok. Then GPS Garmin device is configured (Fig. 11).

## RESULTS AND DISCUSSION

This proposed system deals with location of exact position of the vehicle and record the position in the memory with the support of angstrom OS in the beagle board and global positioning system. It was successfully developed in 2 phases, hardware and software. The hardware design resulted in interfacing GPS to the beagle board. The software part includes developing and testing with the support of Angstrom OS commands and programming of received data format from GPS receiver. With this received data, the position and location of the vehicle is tracked and recorded into SD card.

First, the mobile operating system ANDROID OS was loaded on to beagle board by using an SD card. A GPS

icon was created on the display unit. Because of the Android OS which supports only JAVA, some errors occurred when interfacing a GPS receiver with beagle board. Therefore android OS is replaced with the Angstrom OS. An ANGSTROM OS with OPEN EMBEDDED and BITBAKE was installed on the Beagle board. An image which is compatible with OMAP and kernel configuration is used and compiled. Installation of ANGSTROM OS on to the beagle board is shown in Fig. 11a, b.

RS232 is used to interface beagle board with serial to USB converter and GPS receiver. The interfacing module with the board is shown in Fig. 12. Interfacing of GPS receiver and beagle board is implemented successfully as shown in Fig. 13. The screenshot of the result of the proposed model is shown in Fig. 14. In Fig. 14, we observed that, the vehicle and driver position is located by the satellite of the GPS receiver.



Fig. 12: Interfacing of serial to USB converter



Fig. 13: GPS receiver interfacing with Beagle board

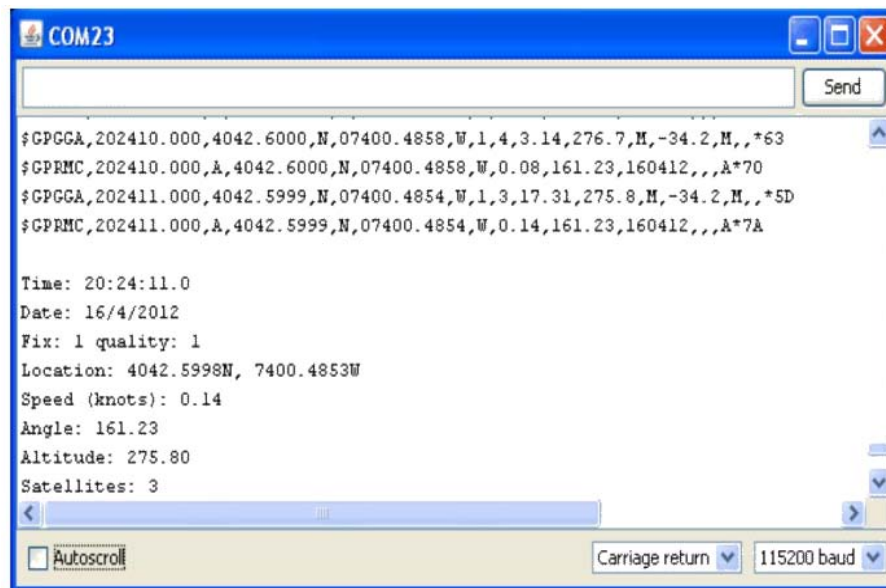

Fig. 14: Screenshot of received GPS data



## CONCLUSION

“Interfacing of gps receiver and gprs modules with Beagle board for driver safety assistance system” has successfully implemented and tested on beagle board. It was developed by integrating hardware modules with the software programming. This system has the advantages of low cost, simple, low power and easy to operate. So, that it is suitable for various applications. It avoids deaths of drivers due to accidents in high-ways. This system is useful for driver assistance system as well as for tracking purposes.

## REFERENCES

- Albert, A. and R. Ezhilarasie, 2011. Cloud computing based vehicle tracking information systems. *Intl. J. Comput. Sci. Technol.*, 2: 49-52.
- Bhilare, P., A. Mohite, D. Kamble, S. Makode and R. Kahane, 2015. Women employee security system using GPS and GSM based vehicle tracking. *Int. J. Res. Emerging Sci. Technol.*, 2: 65-71.
- Boopathi, S., K. Govindaraju, M. Sangeetha, M. Jagadeeshraja and M. Dhanasu, 2014. Real time based smart vehicle monitoring and alert using GSM. *Intl. J. Adv. Res. Comput. Commun. Eng.*, 3: 8424-8427.
- Krishnasree, V., N. Balaji and P.S. Rao, 2014. A real time improved driver fatigue monitoring system. *WSEAS. Trans. Signal Process*, 10: 146-155.
- Mamatha, A. and S. Aravind, 2015. An innovative vehicle safety assistance system for vital signal monitoring. *Intl. J. Eng. Res. Appl.*, 1: 28-30.
- Ranganath, K., M. Rajeshwar, N.K. Laskari and T.V.N. Rao, 2011. Hotspot detection by using GPS and GPRS System. *Comput. Sci. Eng. Technol.*, 1: 1-5.
- Ravi, C. and M. Srujana, 2015. Real time monitoring of vehicle driver assistance condition by using GPS and GSM modules. *Intl. J. Prof. Eng. Stud.*, 5: 10-14.
- Shah, S., S. Patel and H. Narula, 2014. Intelligent vehicle theft control using embedded system. *Intl. J. Comput. Appl.*, 107: 34-37.
- Singh, S., S.C. Dutta, D.K. Singh and S.K. Singh, 2012. Enhancing highway traffic safety through intelligent car. *Intl. J. Distrib. Parallel Syst.*, 3: 149-157.
- Yalic, H.Y., A.S. Keceli and A. Kaya, 2013. On-board driver assistance system for lane departure warning and vehicle detection. *Intl. J. Electr. Energy*, 1: 132-136.