

## Chloride Induced Stress Corrosion Cracking (CISCC) of Austenitic Stainless Steel under Thermal Insulation at Ambient Temperature

Prema Sivanathan, Mokhtar Che Ismail and Kee Kok Eng  
Department of Mechanical Engineering, Universiti Teknologi Petronas,  
32610 Bandar Seri Iskandar, Perak, Malaysia

**Abstract:** Based on recent case study from petrochemical industry vessel leakage incident was taken to investigate failure of Chloride Induced Stress Corrosion Cracking (CISCC) of austenitic stainless steel 304. The objectives of this research was to investigate the reasons for CISCC failure of austenitic stainless steel 304. To simulate CISCC initiation of austenitic stainless steel 304 in different chloride concentration environment at ambient temperature. In this study, ASTM G-30 U-bend standard test method was used to evaluate factors that affect the CISCC of austenitic stainless steel 304. Total of 6 U-bend specimen were prepared with 200, 4000, 5000, 6000, 7000 and 8000 ppm of chloride concentrations. All these specimens were immersed in sodium chloride aqueous solutions for 8 months period to determine the parameters which leads to appearance of initiations crack mode. The laboratory experiment then repeated with the same specimens with 50,000 ppm chloride concentration for another 3 months. However, after cleaning the U-bend specimen and conducted dye penetrant inspection there were no appearance of initiation of crack found in any of specimens. Non-Destructive Testing (NDT) is one of assessment method used for detecting the CISCC susceptibility. The dye penetrant testing was used to identify the crack but invisible on the surface of the specimens. As a result, no initiation of crack found in this research from a metallurgical failure investigation of CISCC at ambient temperature. Thus, CISCC requires a long period exposure time for a rough surface finish of austenitic stainless steel 304 to form localized corrosions to lead the cracking mechanisms which is a complex process.

**Key words:** Corrosion, cracking, chloride concentration, stress, failure, investigation

---

### INTRODUCTION

Chloride Induced Stress Corrosion Cracking (CISCC) typically caused by leached out chloride compounds from insulation material such as perlite used in thermal insulation inside pressure vessel. However, localized corrosion on austenitic stainless steel 304 due to the effect of chloride presence still remain a complex process in some corrosive environment. Thus, this phenomenon shorten the equipment life (Parrott and Pitts, 2011a, b).

CISCC at ambient temperature can experience Stress Corrosion Cracking (SCC) if used in a specific environment to which the austenitic stainless steel 304 has insufficient corrosion resistance. The deterioration of metal during longer exposure time with chloride ion can leads to the formation of martensite at ambient temperature via. thermodynamically. The process may be insufficient to form spontaneously due to limited driving force. Therefore, diffusionless shear mechanism can transform unstable austenite to formation of martensite this is also possible only if the shear is provided mechanically by external forces. However, the degree to

which it occurs varies with element composition presence in austenitic stainless steel 304 and usually happens during the deformation process.

In short, the following conditions are necessary for CISCC to occur: a susceptible metal, a specific environment and a tensile or residual stress (Batty *et al.*, 1984). Stress corrosion cracking is the cracking of a susceptible metal under the combined influence of a tensile stress either residual or applied in a corrosive environment. The cracks are initiated and propagated by the combined effect of stresses and the environment. The SCC cracks can be both intergranular or transgranular depending on the alloy, stress conditions and the environment. Intergranular cracking occurs along the grain boundaries (Garcia *et al.*, 2001). Transgranular cracking occurs across the grain. Usually, transgranular cracking is the most common type in this chloride environment.

**Problem statement:** Corrosion Under Insulation (CUI) is a well-understood problem and mitigation methods are well established. However, recurrent failures still occurs in industry, this study purpose is to simulate a

reproducible level of leachable chloride which could possibly identify the parameter leads to CISCC. In this research similar case study within the process industries was taken. Austenitic stainless steels 304 the main forms of corrosion are pitting and stress corrosion cracking are caused by chlorides. Lots of financial expenses involved due to such failures by CISCC to repair and maintenance of the equipment attacked. Chloride Induced Stress Corrosion Cracking (CISCC) of 304 stainless steel under thermal insulation is a severe problem which causes the production downtime (Winnik, 2015).

**Objective:**

- To simulate CISCC initiation for austenitic stainless steel 304 in different chloride concentration environment
- To investigate the effect of CISCC at ambient temperature and identify the parameters contribute to CISCC

**MATERIALS AND METHODS**

A case study was taken to understand stress corrosion cracking mechanism on austenitic stainless steel 304. This leads to an experimental stimulation in corresponding to the relevant results obtained from the inspection site.

**Design details**

**Material:** AISI type 304L austenitic stainless steel.

**Environment:** Gas processing plant pressure vessels under thermal insulation at north and south plant was leaking during operation. Chloride concentration and temperature used is the main contributing factors to the susceptibility of stress corrosion cracking in austenitic stainless steel 304.

**Detection of crack and characterizations**

**Visual inspection:** Sub-surface cracks were identified initially by using simple visual inspection method.

**Non-destructive testing:** Dye-penetrant testing used to inspect surface cracks in depth and the crack lengths on the vessels was measured. Characterization of crack morphology: Microstructure, SEM and EDX.

**Experimental design from case study:** The experimental set-up to study the stress corrosion cracking contributing factors which is chloride concentrations on the austenitic stainless steel 304 susceptibility at ambient temperature. Figure 1 shows the schematic diagram of U-bend sample preparation stages

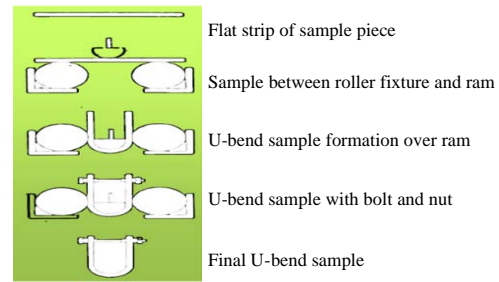

Fig. 1: Schematic diagram of U-bend sample preparation stages as per ASTM G30 (Prakash *et al.*, 2014)

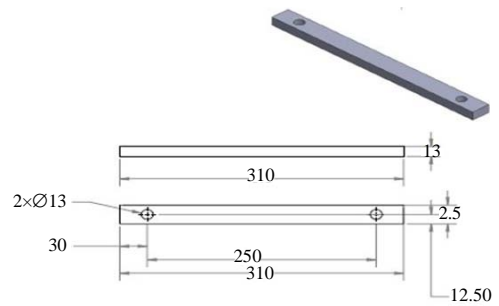

Fig. 2: Flat specimen with dimension (mm) (ASTM., 2000)

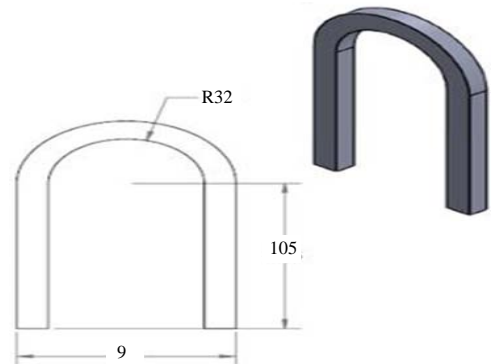

Fig. 3: U-bend test specimen with dimensions (mm) (ASTM., 2000)

as per ASTM G-30. U-bend sample preparation: a U-bend specimen is prepared from a flat bar which bent 180° levels as given dimension in Fig. 2. A bolt and nuts are used to tighten up to sustain a constant strained conditions throughout stress corrosion testing. Figure 3 shows the U-bend sample with dimension (mm) as recommended in ASTM G-30.

The U-bend specimens were immersed in sodium chloride solution at ambient temperature. The base metal of austenitic stainless steel 304 sensitized condition with various chloride concentrations such as 200, 4000, 5000,

6000, 7000 and 8000 ppm chloride for set 1 were tested for the duration of 8 months at ambient temperature. After visual and dye-penetrant inspection the experiment then repeated again with 50,000 ppm chloride for all the specimens, since, there were no crack initiation were observed.

**RESULTS AND DISCUSSION**

Based on Non-Destructive Testing (NDT) the crack appearance and length has been measured. The gas processing plant pressure vessels at North and South plant view was leaking during operation. Material used is AISI type 304 austenitic stainless steel. Table 1 shows the design data for the pressure vessel. Figure 4 shows the schematic design of pressure vessel tank.

Based on dye penetrant testing on pressure vessel leakage was found from external surface. The pressure vessel was with insulation in operation condition. Failure of the AISI type 304 stainless steel was by leakage. Dye penetrant test was completely carried out at full body and at weld of equipment (accessible area). Based on the inspections conducted on the external surface, linear and rounded indications were found during inspection time. At the external surface of the tanks revealed improper passivation as a results of dye penetrant testing. Few areas was attacked with SCC external surface due to atmospheric corrosion. The inspection results, base and weld metals affected with pitting and crevice corrosion is revealed in Fig. 5.

The results indicated presence of stagnant water in service which supposed to be drained out after the hydrostatic test. In this case, maybe water was stagnant in the vessel. The samples of water should be analysis for CI contents. At a number of places crevices had formed due to weld spatter and excess penetration of weld deposit and gap between reinforcement ring and shell surface (Parrott and Pitts, 2011 a, b).

As the inspection results indicated that the crack was found at the top shell. This crack is the same crack found during external dye penetrant testing (Fig. 6).

The water should have been stagnant for a period of time inside the vessels. However, the corrosion attack was only found at the bottom of the inside surface of the vessels where water was stagnant. Water with the presence of chlorides ions contributed to corrosion at crevices of the tank as showed in Fig. 7. Figure 8 and 9 show the inspection results of measured crack length indications found on the pressure vessel tank.

Table 1: Design data for MD-931

Parameters	Values
Design temperature	-160/60°C
Operating pressure	90.5 Psi (624 KPa)
Design pressure	350 Psi (2413 KPa)
Insulation classes	Perlite (thickness 50 mm)

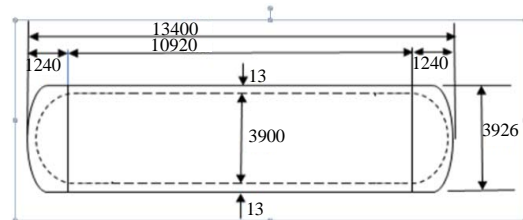

Fig. 4: Schematic design of pressure vessel tank the dimensions are in mm



Fig. 5: General view top shell from east plant side. 1-3 typical finding as above

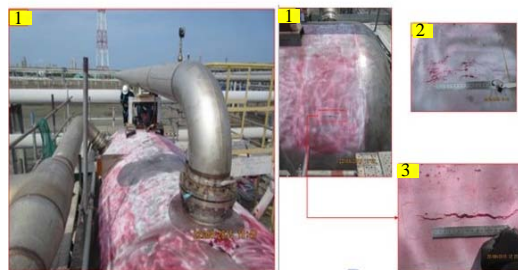

Fig. 6: Crack found at internal top tank same location as the external surface

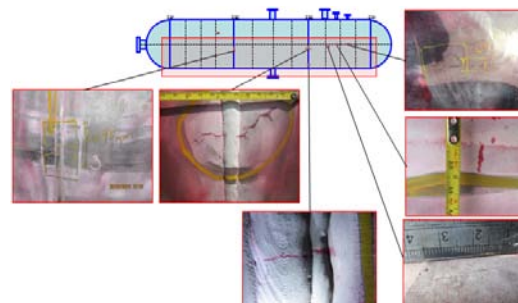

Fig. 7: Mapping of crack indication located at north plant view (bottom half)

Table 2: Set 1 for CISCC experiment for 8 months at ambient temperature



















Temp. (°C)	Cl (ppm)	Cl (g)	Stereo microscope inspection	Dye penetrant inspection	Visual and microscope inspection results	NDT results dye penetrant testing
Room temperature 25°C	200	0.2	Pitting corrosion	No crack		
	4000	0.4	Pitting corrosion	No crack		
	5000	0.5	Pitting corrosion	No crack		
	6000	0.6	Pitting corrosion	No crack		
	7000	0.7	Pitting corrosion	No crack		
	8000	0.8	Pitting corrosion	No crack		

Table 3: Set 2 for CISCC experiment for 3 months at ambient temperature (repeated specimen)

Temp. (°C)	Cl (ppm)	Cl (g)	Stereo microscope inspection	Dye penetrant inspection	Visual and microscope inspection results
Room temperature 25°C	50,000	50	Pitting corrosion	No crack	
	50,000	50	Pitting corrosion	No crack	
	50,000	50	Pitting corrosion	No crack	
	50,000	50	Pitting corrosion	No crack	
	50,000	50	Pitting corrosion	No crack	
	50,000	50	Pitting corrosion	No crack	

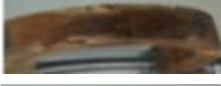
CISCC in laboratory tests has been conducted as per NDT results shown in Table 2 and 3, however, there were no initiation of crack observed in all these specimens. The results indicated that among the six U-bend specimens tested, the material with the highest chloride concentration revealed severe pitting corrosion. In this case study, the mechanism and conditions which may give rise to ambient temperature has been tested. In

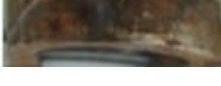
contrast there is only severe pitting corrosion significant difference was noted between at ambient temperature. The breakdown of passive film on the metal surface of austenitic stainless steel 304 leads to localized pitting corrosion. For stress corrosion cracking to happen on the surface of a metal, the applied load on U-bend specimens and various chloride concentration alone cannot determine the root cause of

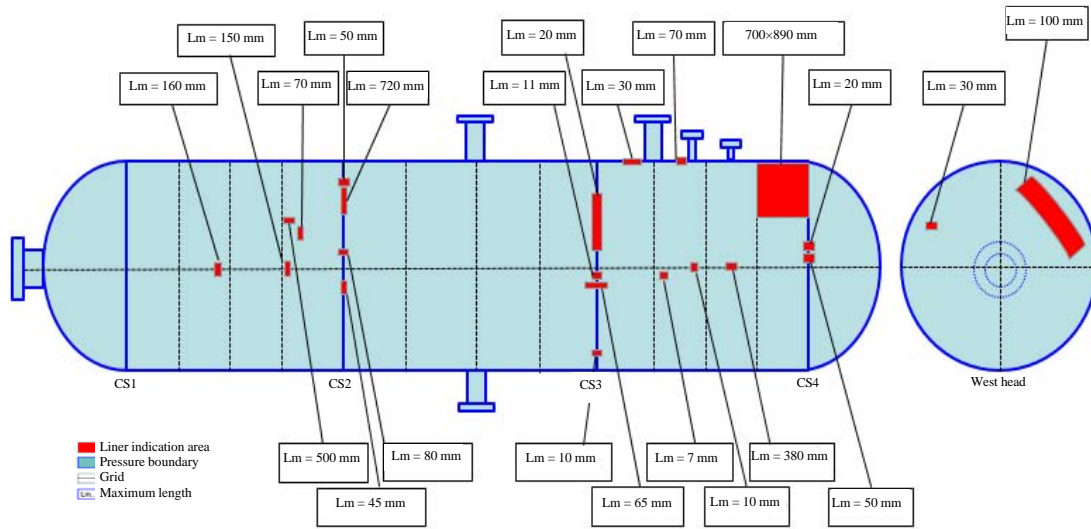

Fig. 8: Linear crack indication (North plant view)

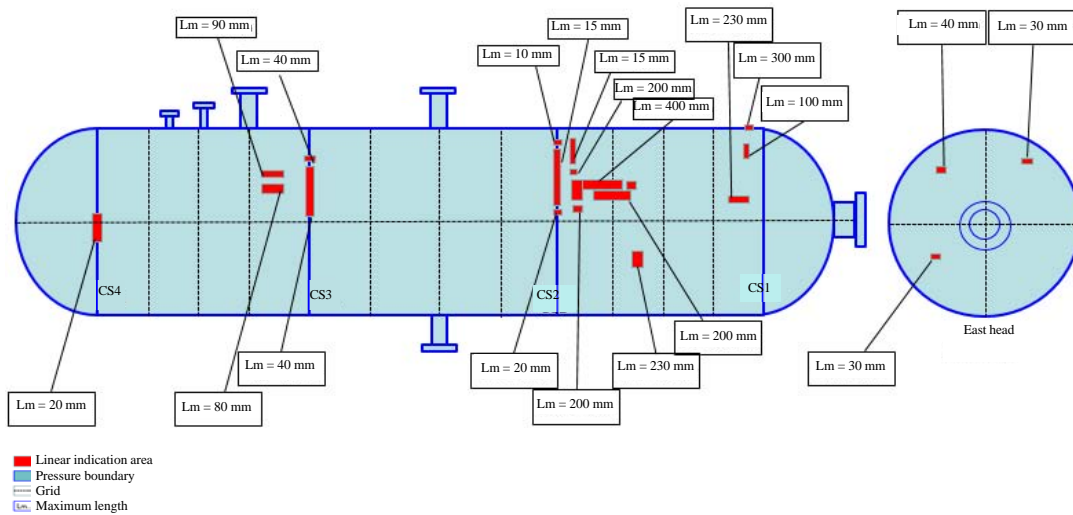

Fig. 9: Linear crack indication (South plant view)

failure. Basically, initiation of crack requires a longer period of time with three SCC conditions which is applied stress, susceptible metal and a specific environment required (Wirdelius and Osterberg, 2000).

**CONCLUSION**

Pitting and crevice corrosion can be precursors to CISC on base metal austenitic stainless steel 304 with condition longer exposure time to chloride environment. Studies have indicated chloride-induced SCC initiation on austenitic stainless steel 304 at less than the yield stress is possible with sustained load

tensile specimens. In conclusion, no initiation of crack was observed in all these U-bend specimens at ambient temperature for different chlorides concentrations.

**REFERENCES**

ASTM., 2000. Standard practice for making and using U-bend stress-corrosion test specimens. ASTM International Voluntary organization, West Conshohocken, Pennsylvania.  
 Batty, W.J., P.W. O'Callaghan and S.D. Probert, 1984. Corrosion under insulants. *Appl. Energy*, 16: 239-247.

- Garcia, C., F. Martin, P.D. Tiedra, J.A. Heredero and M.L. Aparicio, 2001. Effects of prior cold work and sensitization heat treatment on chloride stress corrosion cracking in type 304 stainless steels. *Corros. Sci.*, 43: 1519-1539.
- Parrott, R. and H. Pitts, 2011a. Chloride Stress Corrosion Cracking in Austenitic Stainless Steel. Health and Safety Laboratory Publication, Buxton, Derbyshire, UK.,.
- Parrott, R. and H. Pitts, 2011b. Chloride Stress Corrosion Cracking in Austenitic Stainless Steel: Assessing Susceptibility and Structural Integrity. UK Health and Safety Executive Publisher, Northern Ireland, UK.,.
- Prakash, T., O.H. John and A.U. Malik, 2014. Studies on the Stress Corrosion Cracking (SCC) behavior of various metals and alloys used in the desalination and power plants. Saline Water Conversion Corporation, Al-Jubail, Saudi Arabia.
- Winnik, S., 2015. Corrosion Under Insulation (CUI) Guidelines: Revised. 2nd Edn., Woodhead Publishing, Sawston, England, ISBN:9780081007143, Pages: 162.
- Wirdelius, H. and E. Osterberg, 2000. Study of Defect Characteristics Essential for NDT Testing Methods ET, UT and RT. SKI Publishing, San Francisco, California.,.