

## Monitoring and Controlling Home Automation System Based on GSM/GPRS Technique

Hussain Alaa Almhana, Samir Jasim Mohammed and Laith Ali Abdul-Rahaim  
Department of Electrical Engineering, College of Engineering, University of Babylon, Babylon, Iraq

**Abstract:** The internet of things has many applications. One of the most important IOT applications is home automation. IOT provides user with monitoring and controlling of home appliances, server security and security in a smart home. Home automation system is a promising method at present to reduce the cost of bill and comfort living homes. The system can be secure and control heater, air condition and etc. In this research, the proposed system is designed and implemented home automation system for monitoring and controlling appliance in the home using automatic and manual way at any time and everywhere. In addition, the proposed system has ability to detect any unwanted movement and arising fire and make alarm the user whatever where are. The proposed system has been built by using the wireless sensor network (ZigBee). A website has been designed to monitor home sensors and control home appliances by reading the information of sensors of the WSN nodes. The microcontroller in the coordinator unit uses to collect the data from sensing node and send the information data to the web site by using GPRS Sim 908. After the microcontroller receives the data sensor from sensing node, the microcontroller will send the data to control unit that will control the system automatically. The system is controlled manually when the homeowner wishes to control the system from the website and the process is performed using Sim 900.

**Key words:** Internet of Thing (IOT), Goble System for Mobile Communication (GSM), General Packet Radio System (GPRS), wireless sensor network (ZigBee), WSN nodes, Sim 900

---

### INTRODUCTION

At present days, home and building automation systems are utilized to an ever-increasing extent. From one point of view they give extended comfort, especially when they are used in a private home. On the other hand, connecting automation systems in commercial buildings do not only increase comfort but we also, monitor and control heating, lighting, ventilation and air condition. Subsequently, the home automation will provide a reduction in total cost of the bill and it also contributes in energy saving which is one of the main issues in the present days (ElShafee and Hamed, 2012). The idea of home automation is the controlling and automating of the home sensors home and the home appliance such as temperature device, light lamp or door lock. The home automation is not a new topic, so that, the home automation based on computer system was already developed in 1960's (Andersson *et al.*, 2015).

Human life has changed by using the internet so that, the internet provides at anywhere and anytime connectivity issue with anyone. Now, the internet is

extended to the Internet of Things (IOT). The computer systems would contact with real world objects or things by using the internet network. Things might consist of any objects, sensor, any device, home appliances, vehicles, etc. One of the application of IoT is home automation. IoT provides to the user for monitoring and controlling of home appliances and security at the server and security in the smart home (Gaikwad *et al.*, 2015).

This study present design and implementation home automation system for monitoring and controlling the home appliance using manual and automatic way at anytime and anywhere.

**Litreature review:** In this part some of the related works that have been development related will be discussed. Lee and Choi (2003) designed and implemented home automation based on Bluetooth network. In his system, the user could monitor and remote control over the Bluetooth technology such as controlling temperature in the Bluetooth. The software program was developed using the visual C++ language. Yuksekkaya *et al.* (2006) proposed system was designed and implemented the

home automation for monitoring and controlling in their method (GSM, internet and speech recognition). The GSM and internet technique provided to the user with control and monitor service inside and outside the home but the speech recognition technique just provided to the user in the inside the home. Gill *et al.* (2009) presented a low-cost and novel ZigBee based home automation system. The designed system permitted the homeowner to monitor and control the home appliances that connected to ZigBee network. Piyare and Tazil (2011) designed and implemented home automation based on Bluetooth using cell phone. The system was consisted of mobile phone which contain Bluetooth Technique and Arduino BT. This system offered the home owner to control the house without using the internet connection. ElShafee and Hamed (2012) presented Wi-Fi technology has been used design and implementation for home automation system. The designed system contained of one server that can control all the hardware system interface module on Wi-Fi network and hardware module that consisted of several sensors and actuators for power management and security. Sagar and Kusuma (2005) presented a home automation system utilizing Intel Galileo that appoint the combination of cloud networking, it provides the user with remote control of various lights, fans and the cloud is used to store the data sensor from microcontroller Intel Galileo. Jadhav and Patil (2016) presented design and implementation home automation using social networking web sites. In this study, the system provided to the homeowner with monitoring and controlling base on Facebook. Adsar *et al.* (2017) presented appliance control system and home lighting using internet of things. The system included the android application, home server and internet-based application.

**MATERIALS AND METHODS**

**Art of state about system component:** There are two type art of state about system component that: Global System for Mobile communication (GSM) and General Packet Radio System (GPRS).

**Global System for Mobile communication (GSM):** In 1980, several nations in Europe watched a tremendous expansion of the cell phone system. However, every nation enhanced its own system. The European Post and Telecommunications Conference (CEPT) was held in 1982 to discuss how the system was chosen whether designing a digital system or an analogue system GSM is globally acknowledged for digital cellular communication. The GSM system has been widely deployed and has been so, popular that the number of persons who can use this technology in 2005 was more than one billion persons. The GSM system provided theuser with several services such as SMS, making a call, voicemail and wait for calls. The important benefit of GSM systems has been a low-cost stand by making calls like higher digital voice quality and text messaging (Mishra, 2007).

The system architecture of GSM network includes several elements: Mobile Station (MS), Base Station Controller (BSC), Base Transceiver Station (BTS), Home Location Register (HLR), Mobile Switching Center (MSC), Equipment Identity Register (EIR) and The Visitor Location Register (VLR) as shown in Fig. 1 (Heine, 1999). Firstly, the most important part of GSM system is Mobile Station (MS) because the user uses the MS to talk. MS is a mobile device that it is located on the user side which consists of two parts: the ME and the SIM. Secondly, the GSM network consists of several Base Station Sub-System (BSS) which makes up the two majorparts: Base Station Controller (BSC) and Base

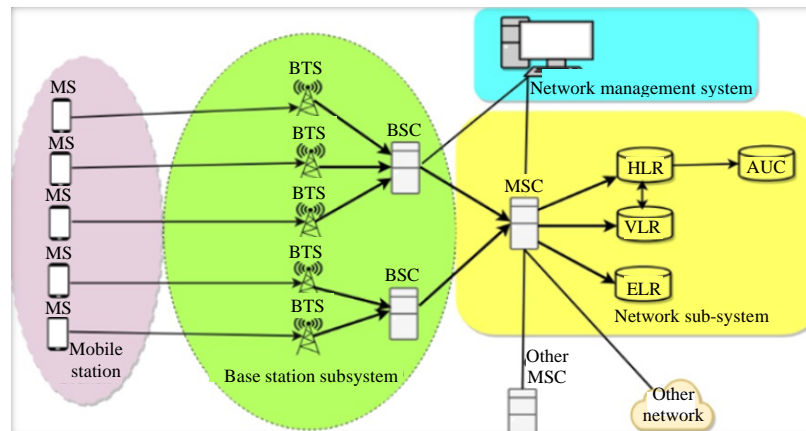

Fig. 1: The GSM network architecture

Transceiver Station (BTS). The BTS plays an important role in the GSM network because it is used to interface between the subscriber and BSC and it is also, utilized to connect the user's mobile system to a network. Another part in BSS is BSC that, it is the main part of the BSC which controls an enormous group of base transceiver station system over a large area. The BSC is taken on the charge of radio resource administration and arrangement. The benefit of the base station controller is removing radio-related loads from the Mobile Switching Centre (Mishra, 2010). Thirdly, the connection between the public network and the GSM network is performed by the NSS. The most important element of NSS is Mobile Switching Centre (MSC). It is taken on the charge of the switching functions that are required for the interconnection between the mobile users and the fixed network users (Ajay, 2004).

Another part in the NSS is HLR that the HLR has stored information for each user's network such as service subscriptions, each user's phone number, authentication data and permissions. Another part in the NSS is VLR that the VLR is similar to HLR that it is also, considered as a database. Nevertheless, it is some difference between VLR and HLR that the HLR is taken on the charge of the static information function while the VLR offers dynamic user information management (Eberspacher *et al.*, 2009). Another part in the NSS is AUC that is too considered as a database that it is taken on the charge of system security in this network (Mishra, 2010). The last part in the NSS is ELR which is also a database that it is used to store the serial number of terminals IMEI. When the mobile device is stolen, the IMEI is recorded in the blacklisted in the ELR which leads to block all calls from or to the taken device (Mishra, 2007). Finally, the major job of NMS is to confirm smoothly the operation of the network. So, there are four major functions: fault management, development network, measurements network and monitoring network (Ajay, 2004).

**General Packet Radio System (GPRS):** Not long after the main GSM systems ended up operational in the mid-1990's and the utilization of the GSM information services began and it turned out that the circuit-switched conveyor services were not especially, appropriate for specific kinds of utilizations with a bursty nature because the connection to the network needs a longer access time by using circuit-switched and the call cost depends on the time of connection. As a result of this they turn to the GPRS service. The GPRS network provides new services for GSM networks that have been developed in a sophisticated and simplified way for wireless access to

packet data networks such as the internet. It is used to transfer subscriber information packets between the external network and the GPRS MS. The benefits of the GPRS technique are that GPRS network has a high data rate and short access time, GPRS reduces the time spent taking down connections and setting up, GPRS is used to support several applications like broadcast services, e-Mail, telemetry, traffic telematics and web browsing and the GPRS offers cheap access to new services (Sanders *et al.*, 2003).

The system architecture of GPRS network is different than the system architecture of a GSM network that the GSM network cannot transmit information in packet switching mode, so, you must add some node in the GSM network to support GPRS services. There are some nodes which must be added to the GSM network to be able to transfer data packet like SGSN and GGSN. Figure 2 shows the GPRS architecture system. The MS in the GPRS network must have the ability to transfer information packets. There are three operational modes for GPRS MS that are (Sanders *et al.*, 2003).

**The operational mode of class A:** The user can use MS for using packet data transfers and making voice calls at the same time.

**The operational mode of class B:** The MS can support the servicing of both GPRS and GSM but the MS can choose one service only. The subscriber can use MS for transferring the data packet and making voice calls.

**The operational mode of class C:** The MS can support the servicing of GPRS or GSM but cannot support both GPRS and GSM and it manually chooses the service. In other words, the subscriber can use MS for transferring the data packet or making voice calls.

The BSS in the GSM network different than the BSS in GPRS network, so, it must be upgraded by adding new GPRS elements such as which is Gb used for linking the BSS with the SGSN. In the GPRS network, the HLR must be improved by this network. The HLR also includes the GPRS user information. The connection between the HLR and SGSN or GGSN will be done by using Gr or Gc interface. The most important element of GPRS network is Serving GPRS Support Node (SGSN) which has various purposes like registration, mobility administration and authentication in addition the SGSN is taken on the charge of routing packet data from and to MS. The SGSN is connected to the BSC, the point at which the service is connected to the MS in GPRS network (Halonen *et al.*, 2003). Another part of the GPRS network is GGSN, the communication between the external networks and the

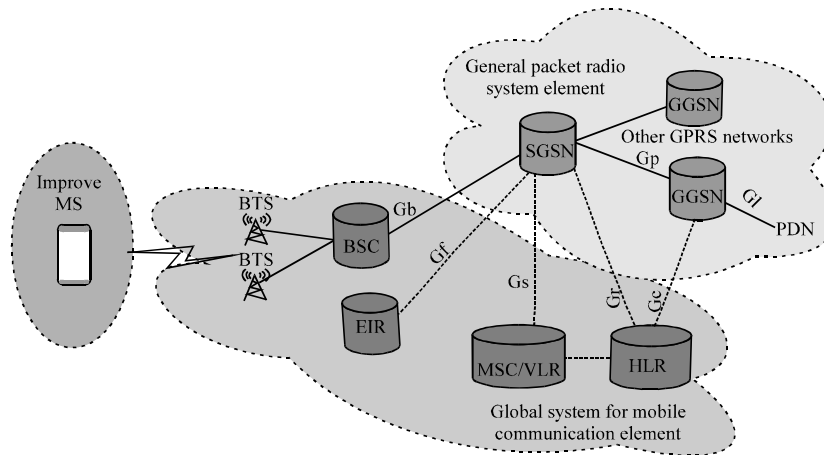

Fig. 2: GPRS architecture system

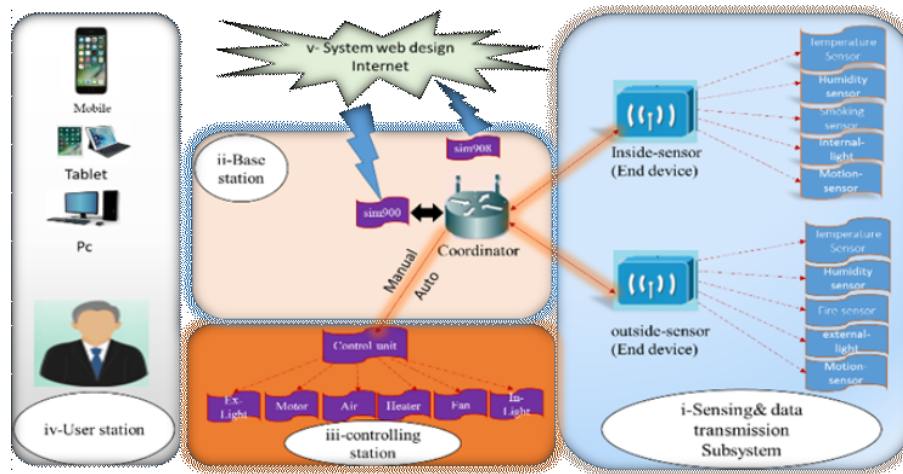

Fig. 3: Home Automation proposed system based on GSM/GPRS

GPRS network like the internet is performed by GGSN. Before sending the data packet to the external network, GGSN converts the GPRS packet coming from SGSN to the “Proper Packet Data Protocol” (PDP) such as IP. The GGSN records the present SGSN heading of the subscriber and his profile in its site registry because it sends these packets to suitable SGSN (Bettstetter *et al.*, 1999).

**Home automation proposed system based on GSM/GPRS:** In this study, a precise system is present to design a home automation that helps to ease the lives of its residents through the implementation of some daily tasks automatically depending on the sensor reading. As a result, it will contribute to energy saving as well as it provides security system. The proposed system has a capability to read home information including: temperature, humidity, illumination level, motion

detection, electricity situation and gas proportion by means of the specified sensors that distributed inside and outside the home. It also, able to monitor and control manual or automatic the home system for any time and any place by using internet.

The system is designed by using the wireless sensor network (ZigBee) because the feature of ZigBee is low cost, low power consumption, more effective, high scalability and more reliable. The system design consists of five parts: sensing and data transmission subsystem base station, control station user station and internet as shown in Fig. 3.

**Sensing and data transmission subsystem:** The first part of the system design is the sensing and data transmission is used to collect the data from home sensors and send to coordinator node. It contains the two sensing nodes: inside home sensing node and outside home sensing

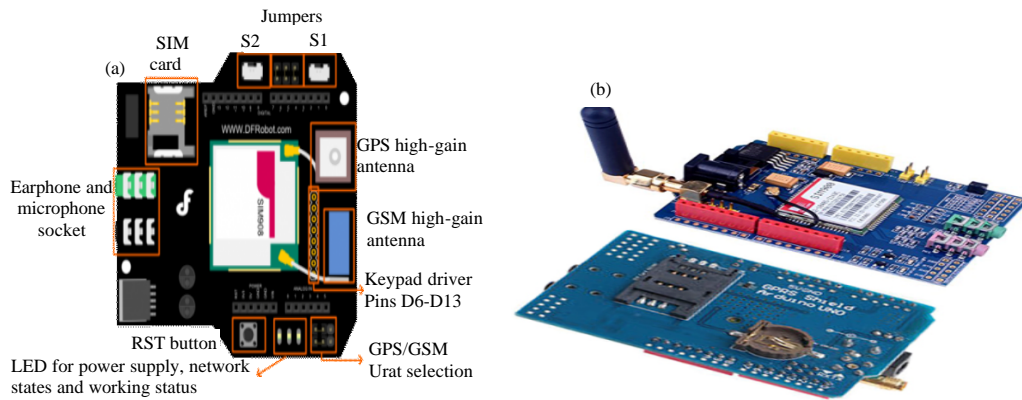

Fig. 4: a) Sim 908 and b) Sim 900

node. The inside home sensing node includes several sensors: inside Temperature and Humidity sensor (DHT22), internal light sensor (LDR), smoking sensor (MQ2) and motion sensor (PIR). On the other hand, the outside home sensing node consists of many sensors: water level sensor (Ultrasonic sensor), outside Temperature and Humidity sensor (DHT22), external light sensor (LDR), motion sensor (PIR) and fire sensor.

**Base station:** The second part of the system design is a base station which consists of three-part coordinator unit, Sim 908-900. The coordinator unit is used to collect the sensor reading data from sensing node. When the data incoming from coordinator unit and control unit, the data can be transmitted to the web side by using the GSM/GPRS Sim 908. Sim 900 and 908 is used to send and receive data form or to website as shown in Fig. 4. The characteristics of Sim 908 and 900 is low power consumption: 100 mA@7V with GSM mode, requires 6-12V@2A power supply, quad Band 850/900/1800/1900 MHz, GPRS multi-slot class 10 and so on. Sim 900GSM/GPRS in this system is used to download the data from the web side to the control unit.

**Controlling station:** The third part of the proposed system is the controlling station which includes several actuators like external light, internal light, air conduction, motor, heater and fan. The system can be controlled in two ways: manual and automatic. When the user has used the manual control, the control unit receives the data from web site by using Sim 900. On the other hand when the user has used the automatic control, the control unit receives the data from coordinator unit and display the data on the web site by using Sim 908.

**User station:** The four part of the proposed system is the user station, the user can be monitored

and control all systems by using internet whether it uses mobile phone or tablet or PC computer.

**System web design:** The web application is used to detect discovery sensor reading. The web application of the propose system is designed by utilizing several languages: AJAX, HTML, JavaScript, PHP server, MYSQL database and JSON. MYSQL database is used to record the information sensor. Figure 4 shows that, the inside and outside home page.

**System operation:** There are several steps that illustrate the work of the proposed system. The first step in the proposed system is the coordinator node who sends the beacon packet data to each sensor node through which the coordinator node is asked into sensor node to send the information sensors.

After sensor node reading data, the sensor node can send the information sensors to coordinator node. When the coordinator node will receive the data from each node, the coordinator node will send the data packet to the website by using GPRS techniques (Sim 908) and at the same time, the coordinator node will send the sensor data to control unit for the purpose of automatic control such Internal light, External light, Fan, Motor, Smoking-Buzzer, and so on.

The final step in the proposed system is the manual control actuator when the user wants to control manually the home appliance from the website. The system uses a GPRS technique to receive data from website to control unit. The Sim 900 is used to download data from websites like internal-light, motor, fan, external-light, air-conditional and heater.

The hardware proposed system consists of five-part station: inside home node station, outside home node station, gateway station, control station and user station (PC) as shown in Fig. 5.

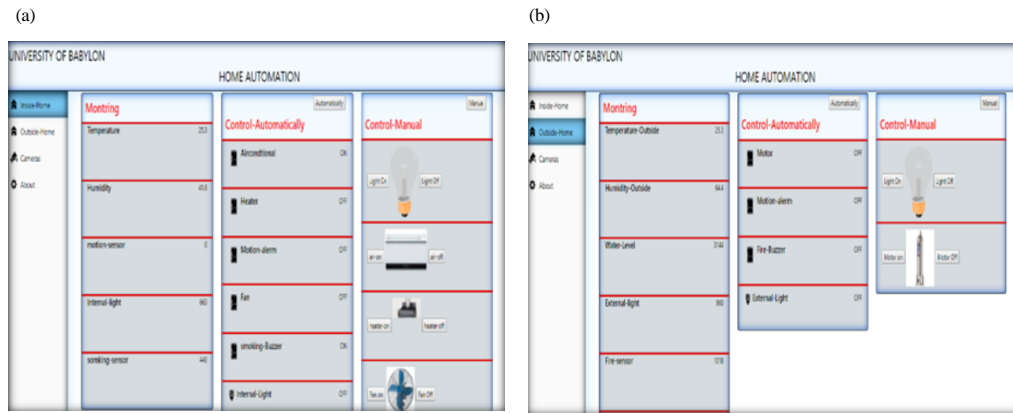

Fig. 5: GUI Home page: a) Inside and b) Outside

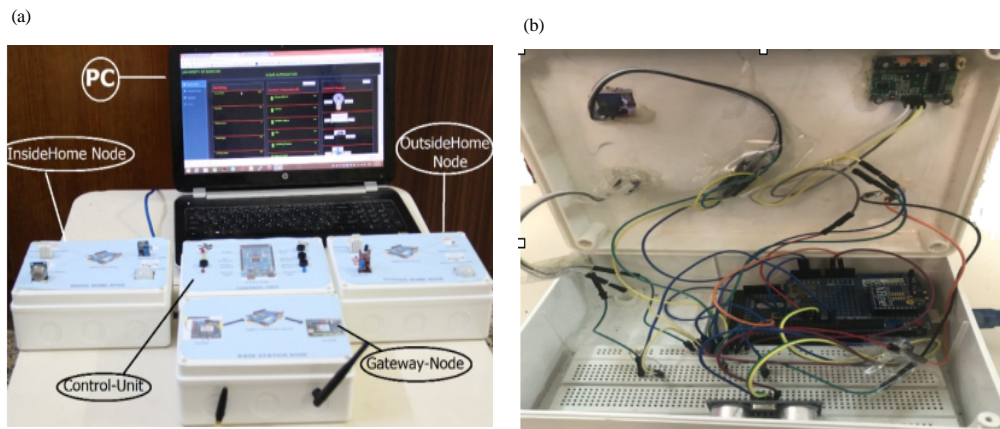

Fig. 6: Hardware implementation of proposed system

### RESULTS AND DISCUSSION

The web application is used to display the numeric data sensor as shown in Fig. 4. The user can monitor and control the home system by using the website panel. To access this panel, a personal computer is used. The system control process depends on two types, either manually or automatically. The system is controlled manually when the homeowner wishes to control the system from the website and the process is performed using Sim 900 for example, controlling fan or internal-light or external-light or motor or heater or air-condition. Figure 6 shows that, when the user wants to control manually, the user clicks on the light button, fan, heater or air conditioner. So, the existing image button will change from one shape to another.

System design includes many display and control situations when the user wants to automatically control the inside of the house:

**The operation of temperature and humidity inside home:** The first case of home system is the temperature and

humidity sensor. It is used to measure the relative temperature and humidity in the inside home. It consists of three cases when the user uses the automatic control mode as shown in Fig. 7. When the temperature value is below the 18°C, the micro controller will turn on the heater LED and at the same time the user will show in a web site that the heater icon is turned on. When the temperature value is between 18-25°C, the micro controller will turn on the fan while at the same time the user will see that the fan icon is turned on. When the temperature value exceeds 25°C, the micro controller will turn on the air-condition LED while at the same time the user will see that the air-condition icon is turned on.

**The operation of internal light in home:** The second case is the internal light that the sensor use in this case is the Light Depend Resistance (LDR). The LDR is used to detect the intensity of light and control the internal light in this home. The LDR contains the internal resistance that depends on light intensity so when the intensity of light is high, the value of internal resistance is low and vice. This case is used to control the internal light such as





Fig. 7: Anually controlling in web page

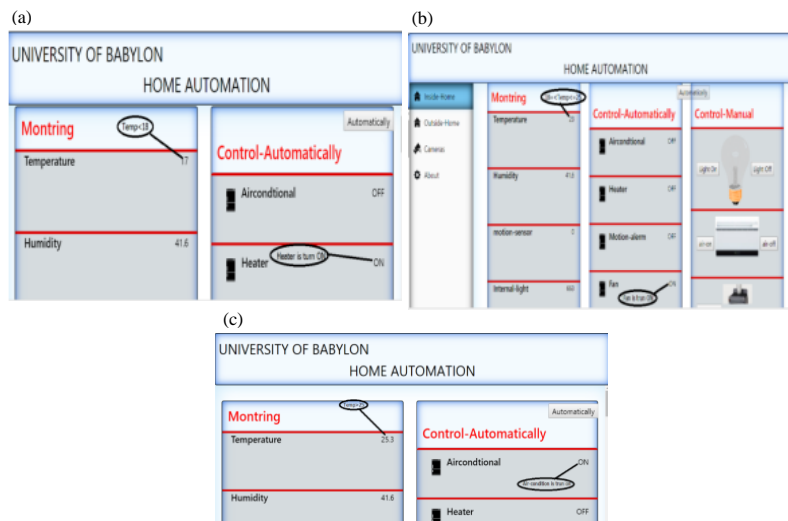

Fig. 8: Cases of temperature in the website: a) Heater; b) Fan and c) Air-conditional

when the value of light intensity is exceed than 700, the micro controller will turn on the internal light LED and at the same time the user will show in a web site that the internal light icon is turned on as shown in Fig. 8.

**The operation of motion detection for security:** The third case is the detection of motion that the sensor uses in this case are PIR sensor. PIR is a digital sensor that it uses to sense the motion in the inside home. Any movement you get inside the house the PIR sensor is detected. The micro controller will turn on the buzzer and the user will view on the web site that the icon of motion-alarm is turned on when the output value of PIR sensor is digital high as shown in Fig. 9.

**The operation of gas level in home for security:** One of the most important case in the house is the gas level. The

sensor use in this proposed system is MQ2 sensor that it is used to detect smoke gases of focus between 300 and 10,000 ppm. When the Gas sensor reading exceeds the threshold value, the micro controller will turn on smoking buzzer and at the same time the user will view on the website that the value of the sensor is exceed threshold value and the icon of a buzzer in control automatic is a turn on as shown in Fig. 10.

The processes that take place in the inside home are the same as those obtained in the outside home, except for some different operations, for example, the water level sensor which uses to measure the water level in the tank. Web outside home page provides user to control manual or automatic motor when the water level in this tank increase or decrease as shown in Fig. 11 and 12.

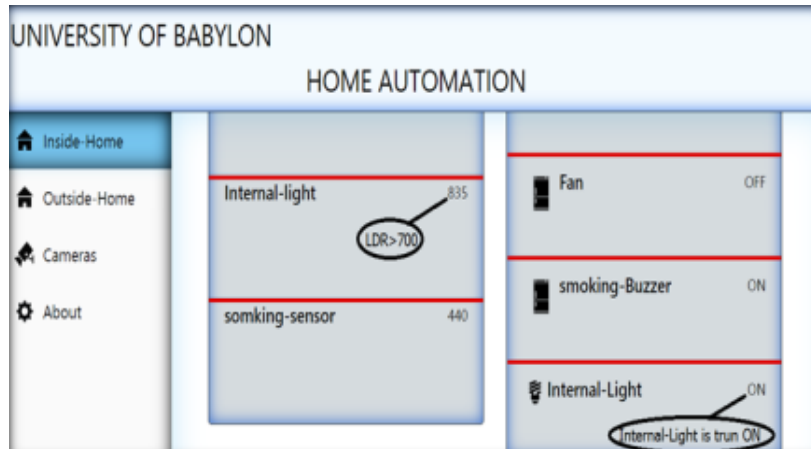

Fig. 9: The internal-light on a website

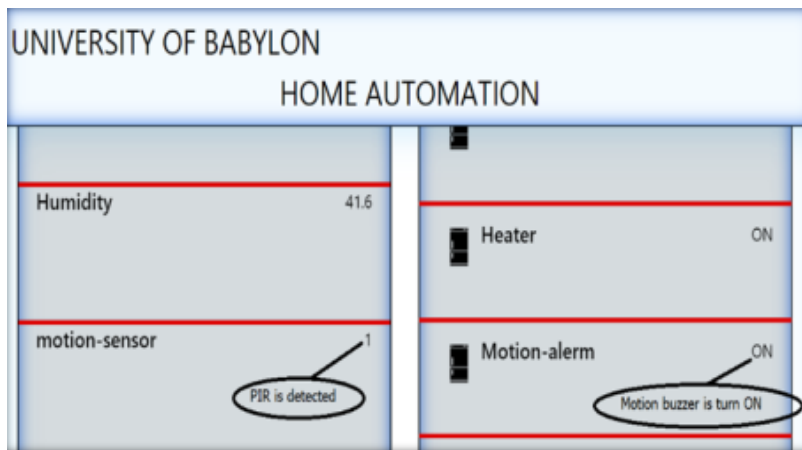

Fig. 10: Motion detection in a web page

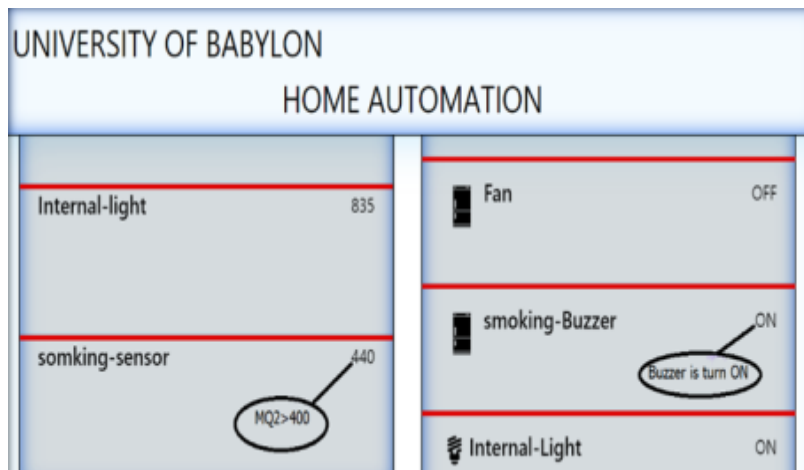

Fig. 11: Gas level sensor



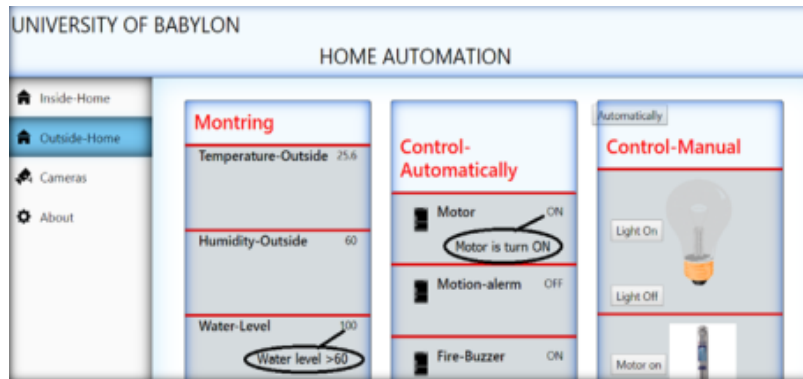

Fig. 12: Water level outside home GUI

### CONCLUSION

The home automation system is designed and implemented using a ZigBee Wireless Sensor Network (WSN) and IOT. The WSN has a good feature like: low installation cost, small device size, reliable and low power consumption. The proposed system consists of ZigBee network, arduino, web application, Sim 908 and 900 GSM/GPRS. Web application is used to build panel for controlling and monitoring home system. Sim 908 is utilized to connect the home automation system to internet to upload the sensors reading information form coordinator node to the website and send the information to control unit. In addition, the Sim 900 is used to download information form the website to control unit when the user wants to control manually the home appliance from the website like fan, motor, internal light, external light, heater, air-condition.

### IMPLEMENTATIONS

In this study, the proposed system is designed and implemented home automation system for monitoring and controlling home appliance using manual and automatic way at anytime and anywhere.

### REFERENCES

Adsar, S.S., T.D. Mutha and P. Lahane, 2017. Home lighting and appliance control system using Internet of Things. *Intl. J. Innovative Res. Comput. Commun. Eng.*, 5: 1363-1367.

Ajay, R.M., 2004. *Fundamentals of Cellular Network Planning and Optimisation: 2G/2.5G/3G... Evolution to 4G*. 1st Edn., John Wiley and Sons Ltd., USA., ISBN-10: 047086267X, pp: 304.

Andersson, M., A. Bastos, S. Blomberg, E. Nyborg and A. Palsson *et al.*, 2015. Home automation for existing devices-automating non-smart devices using Bluetooth mesh technology controlled by Android smartphones. BA Thesis, University of Gothenburg, Gothenburg, Sweden.

Bettstetter, C., H.J. Vogel and J. Eberspacher, 1999. GSM phase 2+ general packet radio service GPRS: Architecture, protocols and air interface. *IEEE. Commun. Surv.*, 2: 2-14.

Eberspacher, J., C. Bettstetter, H.J. Vogel, C. Hartmann, H.J. Vgel and J.R.E. Cher, 2009. *GSM-Architecture, Protocols and Services*. 3rd Edn., John Wiley and Sons, USA., ISBN: 9780470741726, Pages: 338.

ElShafee, A. and K.A. Hamed, 2012. Design and implementation of a WiFi based home automation system. *World Acad. Sci. Eng. Technol.*, 6: 1852-1858.

Gaikwad, P.P., J.P. Gabhane and S.S. Golait, 2015. A survey based on smart homes system using internet-of-things. *Proceedings of the 2015 International Conference on Computation of Power, Energy Information and Commuincation (ICCPEIC)*, April 22-23, 2015, IEEE, Chennai, India, ISBN:978-1-4673-6525-3, pp: 0330-0335.

Gill, K., S.H. Yang, F. Yao and X. Lu, 2009. A ZigBee-based home automation system. *IEEE Trans. Consumer Electronics*, 55: 422-430.

Halonen, T., J. Romero and J. Melero, 2003. *GSM, GPRS and EDGE Performance: Evolution Towards 3G/UMTS*. 2nd Edn., John Wiley & Sons, Hoboken, New Jersey, USA., Pages: 612.

Heine, G., 1999. *GSM Networks: Protocols, Terminology and Implementation*. Artech House, Norwood, Massachusetts, USA., ISBN:9780890064719, Pages: 416.

- Jadhav, B. and S.C. Patil, 2016. Wireless home monitoring using Social Internet of Things (SIoT). Proceedings of the International Conference on Automatic Control and Dynamic Optimization Techniques (ICACDOT'16), September 9-10, 2016, IEEE, Pune, India, ISBN:978-1-5090-2081-2, pp: 925-929.
- Lee, K.Y. and J.W. Choi, 2003. Remote-controlled home automation system via. Bluetooth home network. Proceedings of the 2003 Annual Conference on SICE Vol. 3, August 4-6, 2003, IEEE, Fukui, Japan, pp: 2824-2829.
- Mishra, A.R., 2007. Advanced Cellular Network Planning and Optimisation 2G/2.5G/3G... Evolution to 4G. John Wiley and Sons, Hoboken, New Jersey, USA., ISBN-13:978-0-470-01471-4, Pages: 521.
- Mishra, A.R., 2010. Cellular Technologies for Emerging Markets 2G, 3G and Beyond. John Wiley & Sons, Hoboken, New Jersey, USA., ISBN:978-0-470-77947-7, Pages: 306.
- Piyare, R. and M. Tazil, 2011. Bluetooth based home automation system using cell phone. Proceedings of the 2011 IEEE 15th International Symposium on Consumer Electronics (ISCE'11), June 14-17, 2011, IEEE, Singapore, ISBN:978-1-61284-843-3, pp: 192-195.
- Sagar, K.N.V. and S.M. Kusuma, 2005. Home automation using internet of things. Intl. Res. J. Eng. Technol., 2: 1965-1970.
- Sanders, G., L. Thorens, M. Reisky, O. Rulik and S. Deylitz, 2003. GPRS Networks. John Wiley and Sons, Hoboken, New Jersey, USA., Pages: 295.
- Yuksekkaya, B., A.A. Kayalar, M.B. Tosun, M.K. Ozcan and A.Z. Alkar, 2006. A GSM, internet and speech controlled wireless interactive home automation system. IEEE. Trans. Consum. Electron., 52: 837-843.