

A Comparative Study on the Villa Neuilly-Sur-Seine and Housing 4 Composition of Le Corbusier

Jae-Hee Cho

Department of Architectural Engineering, Wonkwang University,
460 Iksan-daero, Iksancity, 54538 Jeonbuk, Korea

Abstract: During early days of architecture, Le Corbusier tested Dom-Ino system which imply the possibility of reinforced concrete. In the late period, different from what Le Corbusier experiment, architecture was focused on form and material that was based on regionalism, primitivism, brutalism and etc. In this thesis Housing 4 composition and Villa Jaoul (Villa Neuille-sur-Seine) have been compared and researched which both represent early and late days of architecture to look underlying theme and overall thinking process of Le Corbusier. The result of this study is as follows: space where it is surrounded by geometric arrangements and architectural elements arouse the inspiration and choose of traffic line. it shares transparency and also inherits the expandability of Dom-Ino system; As a characteristic of interior and exterior of architecture, exchange and share different elements by open boundary, abstractness of the wall forms the relationship with the nature outdoor. Trail of architecture is a overall memories of architectural elements and this trail will reach to soft and cozy place. As conversational tone is added to the followings above, it will remove the massing but increase the optical illusion and motion. Le Corbusier's architecture differ in structural method and possibility of reinforced concrete but still maintained the context of characteristics of space and technique.

Key words: Le corbusier, Villa Jaoul, 4 compositions, transparency, colors, concrete

INTRODUCTION

Significance and background of study: Since, 1909, Le Corbusier and Max Dubois exchanged their ideas and opinions about reinforced concrete. In 1914, they have announced Dom-Ino system which is a simple structure that is consisted of six pillars, three horizontal floor decks and stairs that connects the pillar and the floor. Also, they have developed '5 points of new architecture' which specifically explains the possibility of Dom-Ino system. However, at the similar period of time, Le Corbusier has realized Maison Monol with mechanical white architecture which made his architectural characteristics seem like they have changed into regionalism, primitivism, brutalism and etc. This shows that many other researches focus too much on use of materials and change of forms which lead the researches fail to notice the original element and overall characteristics of architecture.

Thus, this research is trying to see the possibility to discriminate his change of materials and structure by consistent connection or by chronological characteristics. This research will also make a comparative study on Villa Jaoul that shows great example of This study was supported by Wonkwang University in 2018 4 composition of Maison Monol of Dom-Ino system to find out connection between the former and the latter architecture and to understand his architectural principles.

MATERIALS AND METHODS

Method and range of study: In this research, formation of space which is shown in later houses is added to interpretation of the former period of houses to study Le Corbusier's architectural technique. Also, this research will try to study under the premise that advanced houses also have connected spacial nature as former houses. Dom-Ino system has special characteristics such as roof garden, pilotis, window horizon and so on. It started in a similar period of time when 4 composition of houses announced and the study will show the similarity between Maison Monol that borrowed vault structure and Villa Jaoul that is on a continuity of timeline. The study will be in order below:

- Understand Dom-Ino system and Maison Monol
- Comparison of Housing 4 composition and Villa Jaoul
- Analysis of polychrome's effects on architectural space

Understand Dom-Ino system and Maison Monol

Structure of Dom-Ino: Le Corbusier tried to show reinforced concrete's possibility by implied structure, so, in 1914, he announced Dom-Ino system in a simple structure with one meter of cantilever that has six pillars

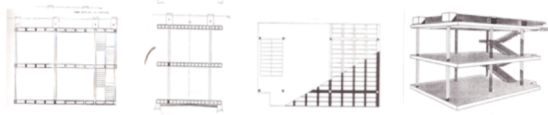

Fig. 1: Dom-Ino system



Fig. 2: Maison Monol

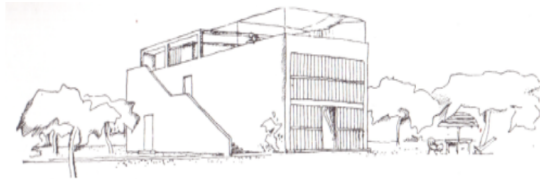

Fig. 3: Maison Citrohan

three horizontal floor decks and stairs that connects them (Fig. 1). Dom-Ino system has three major characteristics. First, standardization and diversity are the base structure and the objective is mass production. Second, cantilever brought change from wall base structure to pillar structure which made planes and elevation free. Third, girder from the ceiling is not shown but unified and frames of pillars and girder are also not shown which made vertical pillar and horizontal decks work as a separate architectural factors. This technique is development of a method of structure and it creates extended and opened space. It has important meaning in architecture and history as C. Rowe pointed out that it is very interesting how center is being ordinary but the edge is being exciting.

Maison Monol: Maison Monol is made in a shape of original form and it was mostly in a form of clustered house (Fig. 2). This type of form limits the height and horizontal extension of the structure by the ceiling which is different from Dom-Ino system since it does not follow the exact method of structure. As an end product, it weakens the meaning but has great possibility in combinations with other factors. For example, it created specific form of ceiling based on spacial effects and function of it and choose suitable materials for the ceiling. This method is quoted in many discussion about the latter part of the house. It used wall or pillar-wall to understand the concept of space and it is also similar to Maison Citrohan (Fig. 3) which has characteristics in wall.



Fig. 4: Villa La Roche

RESULTS AND DISCUSSION

Comparison on Maison Jaoul and Housing 4 composition Arrangements of shared Hall-Villa La Roche and Jeanneret: La Roche, a banker and also an art collector and his cousin, A. Jeanneret demand to build a house for two household in one site (Hyung-Joon and Kwang-Hyun, 1998). Because of a limited space, he decides to build one row house instead of two separate houses. The main entrance hall (Fig. 4) is the focus, since, it is very useful to compare and analyse how two volumes are shared as it is shown in Maison Jaoul's design change in process (Fig. 5).

Maison Jaoul's first design plan shares middle wall and shared entrance hall is place on first floor under the two parallel volume and in second, he minimizes the size of the entrance and rotates the separated volumes in 45 angle. In third, the change was made to a layout that is parallel to the distance facing the site and the two volumes face the entrance diagonally from the rectangular shared entrance. The fourth is a final in which the two houses are placed at right angles to one another and the sharing hall that faces the entrance is facing front. The entering path is on the left side of the ground which forms like two volumes of entrances are placed and overlapping on a big rectangular sharing hall. All of these changes are layered structure of structural wall on the premise of vault structure (Table 1).

Expanded clarity of Dom-Ino system-comparison with Villa Stein: Second composition from 4 compositions is a hard type, since, it is about giving mental satisfaction. Much effort needs to be put into compress and embrace the space especially in one solid and pure rectangular space. He wanted absolute emptiness from Dom-Ino system in a pure volume. Absolute emptiness does not fully means the actual emptiness in structure, it means empty space, visible phenomenal clarity in structure. The transparency in Villa Stein is similar to several depth layers as shown in his Purism painting (Fig. 6) with the front side of the wall being highlighted by the terrace and the first floor being pushed backwards, It's located behind the stairs (Fig. 7). The layer on the back of the

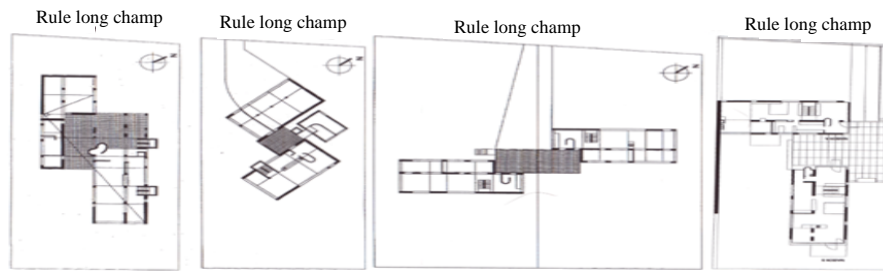

Fig. 5: Changement of Villa Jaoul

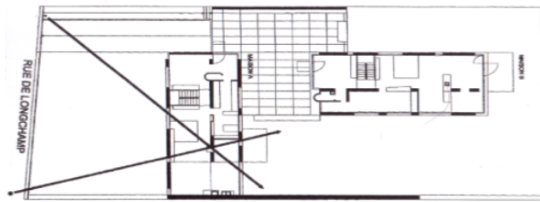

Fig. 6: Dishes, still life and C. Rowe's interpretation

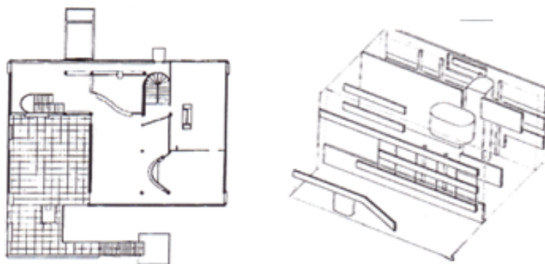

Fig. 7: Plane and analysis of Villa Stein

Table 1: Comparison between Villa La Roche and Jeanneret and Villa Jaoul

House Characteristics/Villa La Roche and Jeanneret	Villa Jaoul
Similarity	
The entrance hall of the square plane	The entrance hall on the square plane
Direct vertical volume	Arbitrary vertical volume
Difference	
Internalization of shared hall	Externalization of shared hall
Parallel traffic line	Right angled traffic line

horizontal window has depth due to the window of the side wall and the terrace wall inside. Simultaneous parallel plates with this depth and transparency indicate the backmost parallel window section across the thickness space.

This transparency is also reflected in architectural transparency and pictorial transparency in the Villa Jaoul. As shown in Fig. 8, the volume parallel to the Lonchamp distance has a visible architectural transparency through the line of sight passing through the openings of the front and rear walls starting from the center wall when entering from the outside, It forms a formative place and creates a rich relationship with the surrounding spaces. Inside the

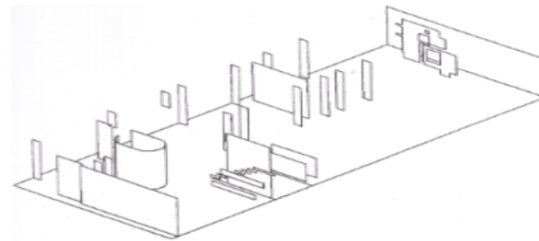

Fig. 8: Transparency view to street

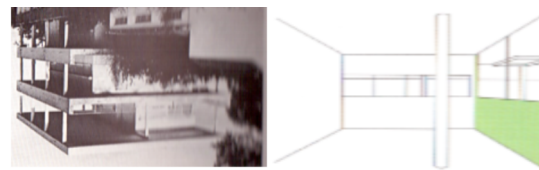

Fig. 9: Analysis for Transparency of Villa Jaoul

Table 2: Comparison between Villa Stein and Villa Jaoul

house characteristics/Villa Stein	Villa Jaoul
Similarity	
Visible, phenomenal transparency	Architectural and painting transparency
Expansion of the center (broad)	Expansion of the center (narrow)
Difference	
Transparency in the upper layer	Transparency of the lower layer
Pure cube volume	Vault volume
Non-visualization of structures using color	The spread of the surface of the structure using color

parallel view, the stairs and plates of the oblique line have the same effect as the star housing and cross the thickness of the space (Fig. 9). This inherits the extended meaning of the transparent space of the Dom-ino system (Table 2).

Continuous interchange of inner and outer spaces

Comparison with Villa Baiseau: The Villa Baiseau is an add-on system using a dome-ino system like Villa Stein but in this case, the pillars surround the outside and each layer appears as a vertical addition and fully conforms to the function in the interior space of the pillars (Fig. 10). This is a very easy configuration in that the freedom of the plane causes freedom of shape. Like the outer circular pillars of the Parthenon where Le Corbusier had influenced, the point where the gaze is directed is not the



Fig. 10: Ext. Villa Baiseau

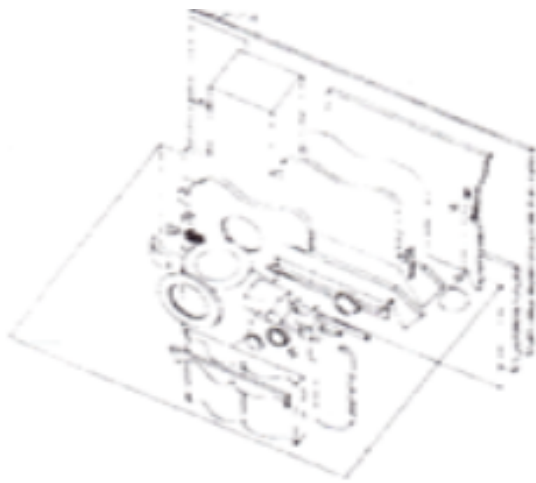

Fig. 11: Int. Villa Baiseau

Table 3: Comparison between villa baiseau and villa jaoul	
Houses characteristics/Villa Baiseau	Villa Jaoul
Similarity	
Continuity of columns Int/Ext	Interchange of elements
Rampe interior	natural and architectural
Difference	
Open boundary by circular columns	Open boundary by walls
Certainty of limit	Ambiguity of limit

center but the outside which creates an open boundary without creating a closed interior space Hegel. In addition, the outer pillars have the same color and shape as the pillars inside the living room but they have the possibility of continuous interchange rather than the effect of the disconnection (Fig. 11 and Table 3).

He states that what he learned in nature is not a landscape but an element of plants and he mentioned that it is necessary to understand how things come together to form the whole Corbusier (1964). In Villa Jaoul, the central wall expresses pictorial transparency similar to Villa Stein while the walls, stoves and shelves have a continuous characteristic connecting with the natural elements as formative abstraction (Fig. 12).



Fig. 12: Interior Villa Jaoul



Fig. 13: Villa Savoye facade and Hall



Fig. 14: Villa Savoye 2nd hall, living room, roof garden

Memory of sight-comparison with Villa Savoye: As many studies of Villa Savoye have shown, it is a representative type of architectural walk. The entrance of the Savoy is guided to the entrance which is indicated by a girder past the piloty space below the building with the symmetrical rear. In the inside of the building, the intent of the rectangular column located between the circular staircase and the ramp (Baker, 1984) will rise to the top in a slope. (Fig. 13). By showing the terrace on the journey to the second floor, the path will be able to imply a movement to the outside. After reaching the second floor, there will be a choice between of entrance among living room, terrace, circular staircase and other rooms. In the living room, formative composition of horizontal windows and long lighting at the top, small walls at the front and the table on the terrace will interest the sight to the outside. The observer who came out will climbs up the ramp leading to the roof to have richness and relaxation in the space of the curved wall functioning as a frame (Fig. 14). All these consecutive movements are possible as a collection of memories of gaze.

The path of Villa Jaoul starts with a ramp that naturally connects the level of the distance with the level



Fig. 15: Entrance rampe and hall of Villa Jaoul



Fig. 17: Photo inside the Villa Jaoul



Fig. 16: Hall, living room of Villa Jaoul

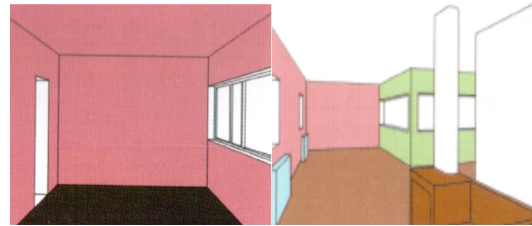

Fig. 18: La Roche's restaurant and Jeanneret's living room

of the ground and leads to a joint space between the volumes arranged perpendicular to each other. The exposed depth of girder and the surrounding space of a terrace and a porch leads selective walk inside structure. First, the volume of the road is selected by stimulating the curiosity of the volume of the terrace (Fig.15). Due to the direction of the stairs and the direction of the chair which are visible from the inside of the porch, the lines of sight to the outside and the lines of the depth to the living room are combined which created dynamics in sight. Before reaching the living room, the ceiling of the vault structure and the opposing formability of the fireplace seems like it is leading to the outside but when viewed in the living room, the upper left window and the lower right window arranged diagonally and placed balance with the perpendicular placement of vertical windows which creates a calm atmosphere like Savoye's roof garden, (Fig. 16).

The architectural stroll to the rooftop in the Villa Savoye is a way of harmoniously coordinating various forms of architectural elements and combining the memories of the observers. The technique of walking is similar to the Villa Jaoul but the final destination is not a roof garden but a fireplace in the living room and that is the only difference from the two (Table 4).

Space effect of polychrome: By pictorial painting in transparency, architectural stroll and sharing of dynamics, Le Corbusier has doubled its effectiveness. Under

Table 4: Comparison between Villa Savoye and Villa Jaoul

housescharacteristics/Villa Savoye	Villa Jaoul
Similarity	
Architectural promenade selective	Promenadememorial
Rampe interior	Rampe exterior
Difference	
Roof garden	Fireplace
Induce to outside	Extensity internal

exposed concrete beams, the central wall of the Villa Jaoul has individual colors and the irregular spaces that are not continuous. In addition, these discontinuous, individual colored walls are also independent of the front, back and side colors, it is not a wall as a volume but a spread of color planes. In other words, the sense of volume as a single color is canceled and it has a planar relation with the faces, thereby losing the feeling of thickness and causing a change in dimension. The origin of the multicolored function can be seen in his comment that it is possible to modify or dispose of the room's particularity (Corbusier, 1997). The colors that made the change were the primitive colors of blue, yellow and red and achromatic colors of white and black. And it was a color combination that seemed steadily, since, the 20's. The difference is the that color of the vault ceiling and the use of natural colors such as exposed concrete, red brick and wood, made the inside of the structure exchange with the nature of the outside (Fig. 17). It is expandable in a closed space such as a pink ceiling and walls in the restaurant of Villa La Roche (Fig. 18). If the ceiling is the same color as the wall, it certainly brings a soft, quiet and seductive atmosphere. We feel as if we are under a kind of vault and close the space. In addition, the right-to-left confrontation between the green and pink walls of the

Table 5: Comparison colours

Houses characteristics/20 ~ 30s houses	Villa Jaoul
Similarity	
Partial use of multicolour	Active use of multicolour
Emphasis transparency and walks	Rhythm of gaze for walking
Difference	
Mostly use on plane	Used under vault construction
Color relationship with white walls	Used to eliminate volume
	Using colors with materials

living room of the Villa Jeanneret is functionally equivalent to the central wall of the Villa Jaoul by the effect of spreading the face. In his comments, the characteristics of architectural colors in early architecture are summarized as follows: (Corbusier, 1931) The blue series (mixed series with green) creates space. It creates a sense of distance and an atmosphere floating in the air. Keep the wall away and make it difficult to realize and eliminate the closure. The red series (brown, orange series) fix the wall. And establishes the exact situation and scale. Therefore, I summarize as follows. Blue-space, Red-fixation of face. In other words, he uses color to correct or transform the character of the space, moving the viewer's gaze and emotions, so that, the space volume inside the building can be felt variously. Despite the differences in structure and usage, this format is applied to the representative houses such as Villa Jaoul in late architecture (Table 5) (Rowe, 1982a, b).

CONCLUSION

The chronological characteristics of Le Corbusier's architecture which can be seen from the results of comparative studies of the 4 composition of the houses and the Villa Jaoul can be summarized as follows (Corbusier *et al.*, 1946). First, the works of 4 composition of houses follow the drip-wall characteristics of a structure by the Dom-ino system and the Villa Jaoul have a drip-wall structure below the local vault ceiling, so that, free space appears in all. Second, in comparison with the entrances, Villa LaRoche has difference in interior and exterior, size, material and entry method but there are many similarities in the method of choosing path for walks and type of inspiration in the space of geometric arrangement and protrusion and linear architectural elements. Third, it shares the transparency of the pure cube, Villa Stein and inherit the expandability of Dom-ino system by creating a deep and rich space through various modeling elements. Fourth, like the characteristics of the Villa Baiseau where the outer pillar with open boundaries interchanges with the inner pillars with ambiguity in Villa Jaoul, due to the abstraction of the central wall, it forms

the hierarchical relationship of outer wall and outer nature. Fifth, the architectural walks to the roof of the Villa Savoye have the same walking technique in the Villa Jaoul, since, they both have the harmonious coordination and arrangement of various forms of architectural elements but the only difference is that final destination is not the rooftop garden but the fireplace in the living room. Sixth, by adding pictorial color to characteristics such as transparency, architectural walk and interaction of architectural elements seen in comparative objects, elimination of voluminousness, vision of sight and multiplication of feeling of movement are shared. However, there is only difference in whether it is multi-color based on the white face or whether the original texture and color are maintained.

For conclusion, through the whole period of Le Corbusier, whether the structure was in Dom-ino system or the Maison Modulor style the only difference is the form of structure and the character of the space, the method of space design and the modeling technique are in the same context.

REFERENCES

- Baker, G.H., 1984. *Le Corbusier: An Analysis of Form*. Van Nostrand Reinhold, New York, USA., Pages: 201.
- Corbusier, L., 1931. [Polychromie architecturale : Study done by an architect (mele, moreover, with the adventure of the painting contemporaine) for the architect]. Fondation Le Corbusier, Paris, France. (In French)
- Corbusier, L., 1964. [Complete Work]. Vol. 1, Editions d'architecture Artemis Publisher, Zurich, Switzerland, Pages : 186 (In Korean).
- Corbusier, L., 1997. *The Final Testament of Pere Corbu: A Translation and Interpretation of Mise au Point* by Ivan Zankis. Yale University Press, New Haven, Connecticut,.
- Corbusier, L., P. Jeanneret, M. Bill and W. Boesinger, 1946. *Le Corbusier: Complete Work*. Vol. 1, Les Editions D'Architecture, Zurich, Switzerland,.
- Hyung-Joon, K. and K. Kwang-Hyun, 1998. A study on the formation process of La Roche Jean Nere housing. *J. Archit. Inst. Korea Planned*, 15: 1-8.
- Rowe, C., 1982a. *The Mathematics of Ideal Villa and Other Essays*. MIT Press, London, England, UK., Pages: 231.
- Rowe, C., 1982b. *The Mathematics of the Ideal Villa and Other Essays*. MIT Press, Cambridge, Massachusetts, ISBN:978-0262680370, Pages: 233.