

## Design and Simulation of Ultrasonic Assisted Distillation Column for Separation Azeotropic Mixtures

<sup>1,2</sup>Taha Mahdi and <sup>2</sup>Ammar Emad Al-Kawaz

<sup>1</sup>Midland Refineries Company, Ministry of Oil, Baghdad, Iraq

<sup>2</sup>Polymer and Petrochemical Industry, College of Material, University of Babylon, Hillah, Iraq

---

**Abstract:** The potential of ultrasound waves to enhance distillation system for azeotropic mixture is examined through process flowsheeting using Aspen Plus. Since, sonication is not a standard feature in the software library, a mathematical model of the proposed distillation system is developed based on first principles in Aspen Custom Modeler and later exported to Aspen Plus environment for process simulation and design studies. Ethyl acetate and ethanol mixture is used as a case study with a target of producing 99% pure top product from a feed containing 65% ethyl acetate. Sensitivity analyses are carried out to examine the influence of various design and operating variables of the top product's purity and heat duties. The proposed distillation system has also been tested for other azeotropic mixtures with similar success.

**Key words:** Process intensification, sonication, azeotropic mixture, distillation design, Aspen Custom Modeler, Aspen plus

---

### INTRODUCTION

Separation of azeotropic mixtures is known to be challenging and many alternatives have been introduced including conventional and emerging processes such as extractive distillation azeotropic distillation, pressure swing distillation, pervaporation and dividing-wall distillation column (Mahdi *et al.*, 2015a). While some of these processes have been in commercial use, there is a need to develop new processes with more attractive capital and operating cost requirements since distillation is widely used in the process industry and consuming large amount of energy. One way of realizing this is by exploiting some peculiar physical and chemical phenomena within existing processes to provide higher efficiency and equipment size reduction. This sets the premise for the development of emerging processes under the theme of process intensification.

One way of applying this approach is to exploit sonochemistry in enhancing the process performance. In addition to the widespread application of ultrasound in facilitating cleaning processes, its application can also be found in reaction systems such as biodiesel production (Chen *et al.*, 2014) and ethanol fermentation (Sulaiman *et al.*, 2011) and separation system such as adsorption (Bono *et al.*, 2008). Its application to distillation process is however still limited. Nii *et al.* (2006) have examined the use of ultrasonic atomizer to disperse

ethanol solution into air streams and concluded that better energy saving processes can be established compared to normal distillation. In another perspective, sonication has also been shown to positively impact the Vapor-Liquid Equilibrium (VLE) of azeotropic mixtures (Ripin *et al.*, 2009). Similar trends are also obtained on other compounds including ethanol-ethyl acetate mixture (Mahdi *et al.*, 2014). Inspired by these results, a mathematical model of a single stage VLE system has been derived and validated (Mahdi *et al.*, 2015b) and based on this model, the design of an ultrasonically intensified distillation system based is proposed and elaborated in this study.

### MATERIALS AND METHODS

**Mathematical modeling:** The schematic diagram of the distillation system is shown in Fig. 1. Using conservation principles and thermodynamic equilibrium as the central principles, a mathematical model of the system is derived. In this process, a feed with a molar flow rate  $F$  and composition  $x_f$  is separated into a lighter top product  $D$  and a heavier bottom product  $B$  with compositions  $x_d$  and  $x_b$ , respectively. Sonication is introduced at each separation stage and each separation stage is assumed to be in phase equilibrium. The model follows a stage to-stage calculation with a top-down numbering approach for the stages (i.e., the first stage is the condenser).

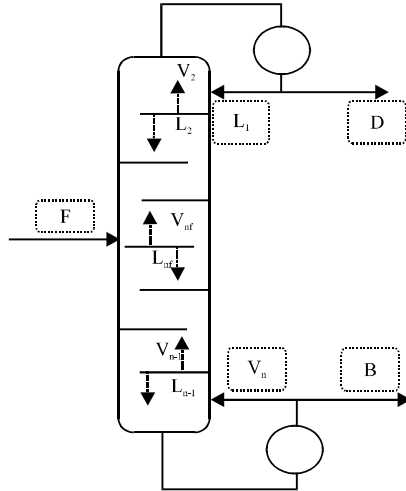

Fig. 1: Schematic diagram of the ultrasonic distillation process

**Material and energy balances:** To illustrate the mathematical modeling for the material and energy balance of the column as shown in Fig. 1, the distillation column is separated into five parts that are explained in the following subsections: condenser, reboiler, feed stage, rectifying and stripping.

**Condenser:** The condenser accepts the vapor rising from the top stage and removes a significant amount of heat to produce liquid that is collected in the distillate drum. In this study, total condensation is assumed. For this subsystem, the overall material and component balance equations are given in Eq. 1 and 2, respectively:

$$V_2 = L_1 + D \quad (1)$$

$$V_2 \times y_2 = (L_1 + D) \times x_1 \quad (2)$$

The condenser duty is the amount of heat transferred from the stream to the coolant and is computed using the energy balance equation given in Eq. 3:

$$V_2 \times h_{v2} = (L_1 + D) \times h_{L1} + Q_c \quad (3)$$

Where:

$Q_c$  = The heat removal from the condenser

$h_v$  = Enthalpies of the vapor

$h_L$  = Liquid phases, respectively

**Reboiler:** The overall material and component balances using the n stage as the reboiler are given by Eq. 4 and 5, respectively while the energy balance that gives the reboiler duty is given by Eq. 6:

$$L_{n-1} = B + V_n \quad (4)$$

$$L_{n-1} \times x_{n-1} = B \times x_n + V_n \times y_n \quad (5)$$

$$L_{n-1} \times h_{L(n-1)} + Q_B = B \times h_{L_n} + V_n \times h_{L_n} \quad (6)$$

where,  $Q_B$  is the required heat input to the reboiler.

**Feed stage:** On the feed stage, the conservation equations are represented by Eq. 7-9:

$$F + L_{nF-1} + V_{nF+1} = L_{nF} + V_n \times V_{nF} \quad (7)$$

$$F \times x_f + L_{nF-1} \times x_{nF-1} + V_{nF+1} \times y_{nF+1} = \quad (8)$$

$$L_{nF} \times x_{nF} + V_{nF} \times y_{nF}$$

$$F \times h_f + L_{nF-1} \times h_{L(nF-1)} + V_{nF+1} \times h_{V(nF+1)} = \quad (9)$$

$$L_{nF} \times h_{L(nF)} + V_{nF} \times h_{V(nF)}$$

Here, the subscript F indicates the values of flows and enthalpies at the feed stage.

**Other stages:** Apart from the specified feed stage, condenser and reboiler all other stages can be represented by generic balance equations for the ith stage as follows:

**Total material balance:**

$$L_{i-1} + V_{i+1} = L_i + V_i \quad (10)$$

**Component balance:**

$$L_{i-1} \times x_{i-1} + V_{i+1} \times y_{i+1} = L_i \times x_i + V_i \times y_i \quad (11)$$

**Energy balance:** In the rectifying section, ultrasonic waves are introduced to the liquid accumulated on the tray. The energy balance equation can be written as:

$$L_{i-1} \times h_{L(i-1)} + V_{i+1} \times h_{V(i+1)} = L_i \times h_{L_i} + V_i \times h_{V_i} + q_U \quad (12)$$

Where:

$i+1$  = The stage below the ith stage

$i-1$  = The stage above the ith stage

$q_U$  = The ultrasonic energy that is provided to the stage by a transducer. It is represented by the ratio of ultrasound intensity

$i$  = The sound of speed in a liquid medium (c) as shown in Eq. 13:

$$q_U = \frac{1}{c} \quad (13)$$

The striping section has the design of an ordinary distillation column and the energy balance equation can be represented by:

$$L_{i-1} \times h_{L(i-1)} + V_{i+1} \times h_{V(i+1)} = L_i \times h_{L_i} + V_i \times h_{V_i} \quad (14)$$

**Thermodynamic equilibrium:** Sonication is a fast process with intermittent spikes of energy appearing on the order of microseconds. It also produces ultrasonic waves that generate micro-point vacuum conditions within the liquid during bubble formation. Because these phenomena happen very fast, the net temperature changes to the bulk liquid are minimal. It is therefore, reasonable to assume that vapor-liquid equilibrium can take place in a similar manner to normal separation processes. The general equilibrium equation for this relationship can be stated as:

$$y_i = K_i \times x_i \quad (15)$$

where,  $K_i$  is the equilibrium coefficient (also referred to as the K-value) that can be a simple or a complex function depending on the methods used to compute the activity coefficient. Treating the components in the liquid phase as a nonideal mixture, the K-value expression can be represented by Eq. 16:

$$K_i = \gamma_i \times \frac{P_i^0}{P} \quad (16)$$

Where:

$\gamma_i$  = The activity coefficient

$P_i^0$  = The vapor pressure of component i and P is the total pressure of the system

The resulting equilibrium relationship yields the modified Raoult's law:

$$P \times y_i = \gamma_i \times P_i^0 \times x_i \quad (17)$$

Note that the components in the vapor phase are treated as an ideal mixture with a fugacity coefficient equal to unity.

**Sonochemistry:** The central theme of this innovation is based on the proposition that the rapid phenomena of generation, expansion, compression and collapse of microbubbles as a result of sonication alter the thermodynamic property of the liquid to the extent that, it positively shifted the azeotrope point. At the limit, an azeotrope is eliminated and high purity separation is made possible via distillation. It is also assumed that the

equilibrium takes place when the bubble is at its maximum size prior to collapse. By calculating the molar composition of the vapor components inside the bubble  $y_i$  at this condition and with the physical properties of the liquid, the liquid composition can be computed using Eq. 17, thus, defining the VLE conditions. Details of this model are explained elsewhere (Mahdi *et al.*, 2015b) and only a summary is provided here.

The molar composition in the vapor phase is computed based on the condition at the maximum bubble size prior to collapse at bubble radius  $R_{max}$ . The molar composition of component i is given by:

$$Y_i = \frac{n_i}{N} \quad (18)$$

Where:

$n_i$  = The total number of component i

$N$  = The total number of all components inside the bubble

The number of moles of component i can be estimated from the ideal gas relationships as:

$$n_i = \frac{4\pi P_i R_{max}^3}{3KT} \quad (19)$$

Where:

$P_i$  = The partial pressure of component i

$T$  = The temperature inside the bubble

$K$  = The ideal gas constant

$R_{max}$  = The maximum bubble radius that can be determined from the Rayleigh-Plesset equation and is influenced by the ultrasonic frequency and intensity

## RESULTS AND DISCUSSION

### Ultrasonic distillation design

**Case study; Ethanol-Ethyl Acetate:** As a case study, Ethanol/ethyl Acetate (ETOH/ETAC) separation process is chosen. Ethyl Acetate (ETAC) is an important solvent that is used in a wide range of applications in the industry and is commonly produced by Esterification of Ethanol (ETOH) with acetic acid. It is assumed that the feed to the proposed distillation system is supplied from a reactor in a typical ETAC manufacturing facility with a product composition containing 65% ETAC at 333.15 K and 1 bar (Katikaneni and Cheryan, 2002). Unfortunately, a mixture of ETAC and ETOH is known to form an azeotrope at 55 mole% of ETAC at a minimum boiling point of 71.8°C, thus making the product purification process very challenging.

**Process simulation:** The proposed distillation system, herein called Ultrasonic Distillation (UD) is similar to an ordinary distillation column except for the addition of an

ultrasonic transducer in the equilibrium stages. For flexibility, the location of these stages depends on the feed composition because it is intended that the sonication stages start from the feed stage to the top column (rectifying section) while the stages of the stripping section are do not have a transducer. Simulation studies on the proposed design based on the mathematical model described above are carried out in an Aspen Custom Modeler (ACM) flowsheeting environment.

A fresh feed stream containing 65 mol% ETAC and 35 mol% ETOH at a flow rate of 100 kmol/h is fed into the bottom of the column because it is above the azeotrope point of 0.55 mol% ETAC. The operating conditions of the ultrasound transducer are based on the optimum operation conditions obtained from previous works (Mahdi *et al.*, 2014, 2015b) which include the settings of 500 W/cm<sup>2</sup> ultrasound intensity and 25 kHz frequency. The reflux ratio and number of stages used are 8 and 35, respectively. According to these operating conditions, the bottom composition is rich with ETOH while the purity of products at the distillate stream contains 99 mol% ETAC. The NRTL equation is used to compute the activity coefficients of the liquid phase because it is recommended for liquid-liquid systems containing an alcohol and non-polar hydrocarbon liquids such as ETAC (Kirpalani and Tol, 2002). For the vapor phase, ideal gas behavior is assumed.

**Separation potentials:** Sensitivity analyses are carried out to study the effect of the distillation design parameters on the quality of separation achieved. This is to verify the adequacy of the design parameters to establish the targeted separation quality.

**Effect of the number of theoretical stages:** The number of theoretical stages sets the size of the column. More stages reflect a taller column and more opportunity for contacts between components thus, increasing the achievable separation. This is illustrated in Fig. 2 where the potentials plateaued when 35 trays are used. At this value, the targeted 99% ETAC purity in the distillate is achievable.

**Effect of feed stage location:** Figure 3 highlights that a feed stage has linear effects on the achievable purity if the feed location is moved above stage 8 to about stage 13 before the sensitivity is reduced. The result also affirmed the choice of stage 17 as the feed location to provide the intended separation quality.

**Effect of reflux ratio:** The effect of the reflux ratio on ETAC composition is consistent with that of normal distillation. Figure 4 shows the upward trend of the

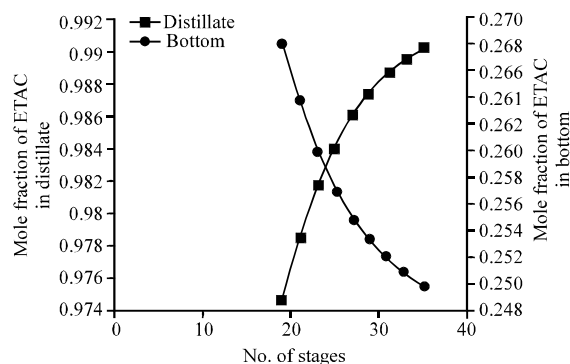

Fig. 2: Effect of the number of stages on ETAC purity in the distillate and bottom streams of the UD column

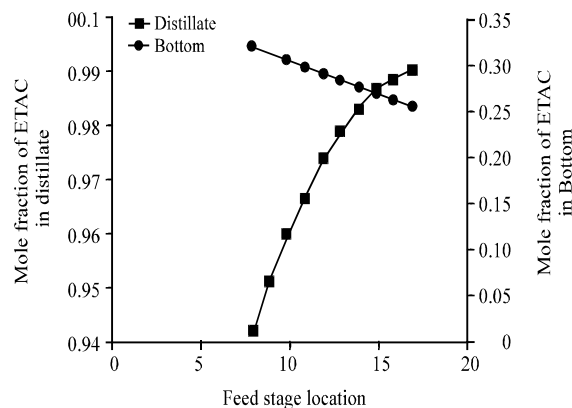

Fig. 3: Effect of feed stage location on ETAC purity in the distillate and bottom streams of the UD column

distillate composition of ETAC with increasing reflux ratio. The desired purity of 99.0 mol% ETAC is achieved when the reflux ratio is set to 8. A rising reflux ratio increased the liquid flow in the column and resulted in more opportunity for contacts between vapor and liquid phases.

**Effect of ultrasonic intensity and frequency:** A salient feature of the proposed ultrasonic distillation system is the use of ultrasonic transducers on the equilibrium stages of the rectifying sections which adds two additional variables, namely ultrasonic intensity and frequency to the process operations. Following a recommendation from the previous experimental work (Nii *et al.*, 2006) with a frequency fixed at 25 kHz, the effect of ultrasonic intensity on ETAC purity is as shown in Fig. 5. It is noted that increasing the intensity provides when the intensity is 500 W/cm<sup>2</sup>. Above this value, the sensitivity significantly declines to finally reach a plateau. As previously explained (Mahdi *et al.*, 2015b) ultrasonic

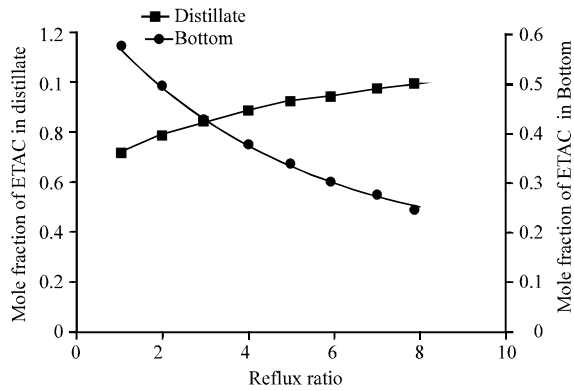

Fig. 4: Effect of reflux ratio on ETAC purity in the distillate of the UD column

intensity impacts the process by varying the bubble populations in the liquid medium. By producing more microbubbles along with the associated vacuum effects inside the liquid, the thermodynamics of the system are impacted to the extent that, it alters the VLE of the system (Zhou *et al.*, 2002), thus, making the separation easier. The effect of the sonication frequency is shown in Fig. 6. Operating at a sonication intensity of 500 W/cm<sup>2</sup>, an increase in frequency results in a negative effect in product purity. Note that, the ultrasonic frequency affects the size of the bubbles formed; the bubble size increases with decreasing frequency. This facilitates mass transfer into the bubbles and their movements upward to collapse on the surface of the liquid as desired by the vapor-liquid separation process.

**Energy requirements:** The addition of an ultrasonic transducer provided advantages as previously discussed. It nevertheless adds an additional energy requirement, electricity. It is therefore important to observe the sensitivity of the proposed design on the overall heat duties of the system. There are three major components of heat duties in the operation of the proposed column, i.e., condenser ( $Q_c$ ), reboiler ( $Q_b$ ) and total ultrasonic related energy ( $Q_u$ ) as shown in Eq. 3, 6 and 13, respectively. The total ultrasonic energy,  $Q_u$ , is calculated by multiplying the energy requirement of each transducer given in Eq. 13 with the number of transducers used in the system. Because, the design parameters such as feed location and the number of stages are fixed based on the purity requirement, the assessment discussed here focused only on key operating conditions.

**Effect of ultrasonic intensity and frequency:** Figure 7 shows that, the condenser and reboiler duties are less sensitive to the changes in intensity and frequency. This

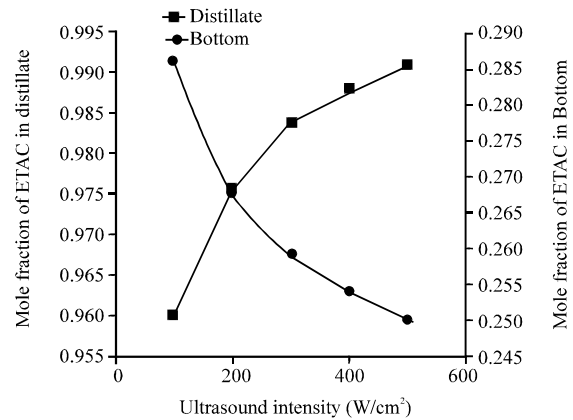

Fig. 5: Effect of ultrasonic intensity on ETAC purity in the distillate and bottom streams of the UD column

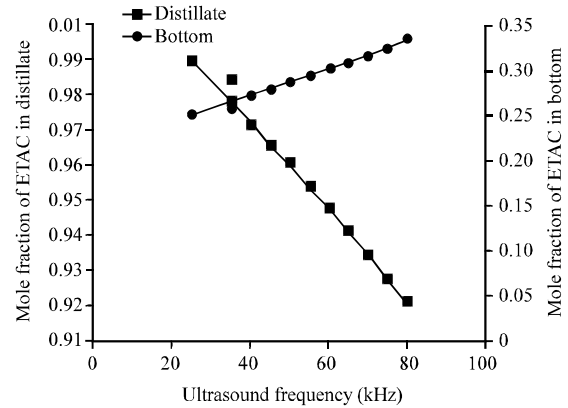

Fig. 6: Effect of ultrasound frequency on ETAC purity in the distillate of the UD column

is because the sonication phenomena have minimal impacts on the bulk temperature of a liquid medium (Merouani *et al.*, 2013). The energy requirement to power the sonication device is not affected by the frequency setting but is strongly influenced by the intensity. This is clearly shown in Fig. 7a where increasing the operational frequency demands higher electrical energy.

**Effect of reflux ratio:** The reflux ratio has a similar influence on the  $Q_c$  and  $Q_b$  as in a normal distillation and is irrelevant to the  $Q_u$ . Increasing the reflux ratio introduces more liquid into the column thus, increasing the energy consumption of the condenser and reboiler heat duties as shown in Fig. 8.

**Optimal design:** The sensitivity analyses provided the response of key performance characteristics towards the design specifications and operating conditions. Based on these insights, the column is optimized to determine the

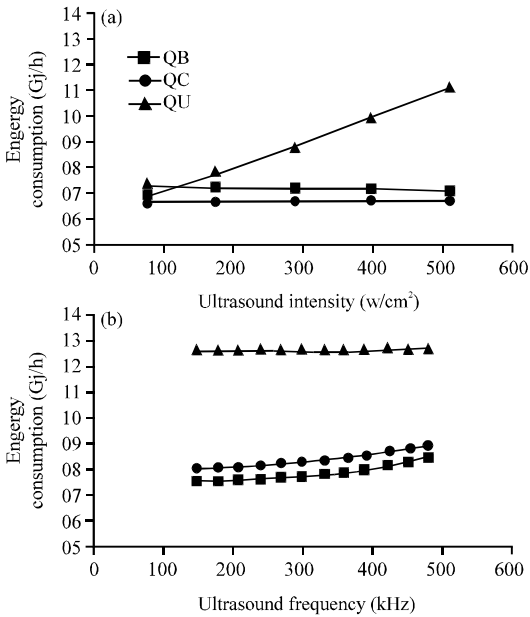

Fig. 7: a, b) Effect of ultrasonic intensity and frequency on condenser and reboiler heat duties of the UD column

optimum settings based on six design variables, aiming at maximizing the ETAC purity in the distillate. The variables are the ultrasound intensity and frequency, number of trays, feed stage locations, reflux ratio and bottom flow rate. This is carried out with fixed feed conditions (flow rate, temperature and compositions) and column pressure. The optimization is carried out using a successive quadratic programming algorithm, known as FeasOpt in the ACM software library (Chang *et al.*, 2012). The results are summarized in Table 1.

**Generalization of the proposed design:** Although, the study focused on the ETAC/ETOH mixture, the proposed design can also be extended to other mixtures. As an illustration, a few selected azeotropic mixtures with different relative volatilities are examined. Azeotropes are formed at 89.4 mol% ethanol at 78.1°C for an ethanol-water mixture, 76.5 mole% of water at 92.4°C for an n-butanol/water mixture and 66 mol % methyl acetate at 53.5°C for a methyl acetate/methanol mixture.

**Simulation conditions:** In all cases, the target product purity of 99 mol% in the distillate stream is set. The design parameters for the distillation system to be used for the various mixtures are fixed using a typical distillation design procedure and operating parameters such as reflux ratio, number of theoretical trays, feed tray location and bottom flowrate feed ratio and other specifications are fixed as shown in Table 2. The results obtained

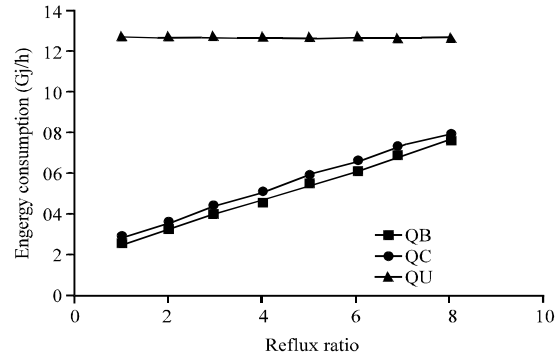

Fig. 8: Effect of reflux ratio on condenser and reboiler heat duties of the UD column

Table 1: Optimum design parameters at ETAC purity of 99.9 mol% for the UD column

Parameters	Values
No. of trays	41.00
Feed stage locations	27.00
Reflux ratio	9.18
Bottom flowrate (kmol/h)	42.23
Intensity (W/cm²)	617.00
Frequency (kHz)	21.40

Table 2: Operation conditions of a UD column for separation of the systems

Specifications of the UD column	Ethanol+Ethyl acetate	Methyl acetate+ methanol	Ethanol+ water	n-Butanol+ water
Average relative volatility	1.15	1.6	2.9	3.1
Reflux ratio	8.00	5.0	3.5	2.0
No. of stages required	37.00	31.0	23.0	20.0
Feed tray location	24.00	19.0	14.0	11.0
Bottom flow rate	60.00	53.0	48.0	45.0

proved the capability of the proposed UD process in providing the intended separations for all of the mixtures. The largest number of stages, 37 is needed for the ETAC/ETOH acetate system while the 20 stages required for the n-Butanol-water system is the lowest number of stages required. The difference in the number of sonication stages required for separating the binary azeotrope mixtures is influenced by the relative volatility of the systems with the highest being the easiest.

The parameters of the sonication device are fixed at the preferred conditions with intensity at 500 W/cm² ultrasound and frequency at 25 kHz and a total flow of 100 kmol/h of saturated liquid at 25°C. Similarly, in all cases, an NRTL Model is used for the liquid phase and ideal behavior is assumed for the vapor phase. For the purpose of comparison, feed compositions for all mixtures are fixed at 50 mol% of the light component. Note that because the purpose of this study is to illustrate only the potential of the proposed designs to be generalized for

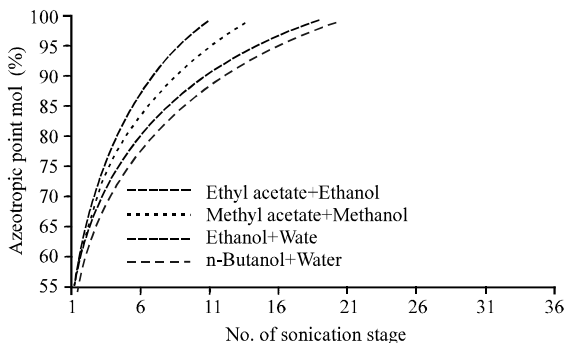

Fig. 9: Azeotropic point of a mixture related with number of sonication stages

other mixtures, optimum operating conditions for each pair have not been determined. Figure 9 shows the shift of the azeotropic point with an increasing number of stages in the rectifying section of the UD column. The results indicate that the proposed UD system is capable of overcoming azeotropes in all mixtures considered. The number of stages required corresponds to their relative volatilities.

### CONCLUSION

This research has successfully illustrated the potential of sonication phenomena in enhancing the separation process involving azeotropic mixtures. The proposed ultrasonic distillation column has successfully achieved the targeted 99 mol% overhead products for various azeotropic mixtures. This preliminary study on the separation of an ETAC/ETOH mixture has shown the benefits of the proposed system in terms of process economy as well as safety perspectives. However, the proposed process is limited only to minimum boiling point azeotropic mixtures. It has nevertheless set a good beginning toward further development of the ultrasonic distillation system.

### LIMITATIONS

**Maximum boiling point azeotrope:** All mixtures previously examined belong to a class of minimum boiling point azeotropes that prefer lower pressure conditions for ease of separation. This coincides with the phenomena in the UD system where the micro-point vacuum conditions introduced by the cavitation bubbles during sonication generate a lower operating pressure environment. This is however, contrary to the requirement for the maximum boiling point azeotropic mixtures such as nitric acid/water and acetone/chloroform mixtures that prefer a high

pressure operation to shift the azeotropic points downward (Ashokkumar *et al.*, 2007; Modla and Lang, 2008). This is an important limitation of the proposed ultrasonic distillation process.

### ACKNOWLEDGEMENTS

Researchers are grateful to the Polymer and Petrochemical Industry, College of Material, University of Babylon for support and infrastructures provided to carry out this research. The contribution of the Ministry of Oil, Iraq in providing scholarships for the study is acknowledged.

### REFERENCES

- Ashokkumar, M., J. Lee, S. Kentish and F. Grieser, 2007. Bubbles in an acoustic field: An overview. *Ultrason. Sonochem.*, 14: 470-475.
- Bono, A., R. Sarbatly, D. Krishnaiah, P.M. San and F.Y. Yan, 2008. Effect of ultrasound on liquid phase adsorption of azeotropic and non-azeotropic mixture. *Catal. Today*, 131: 472-476.
- Chang, H., S.H. Cheng, H.C. Chiang, Y.H. Chen and Y.Y. Chang, 2012. Simulation study of an integrated methanol micro fuel processor and fuel cell system. *Chem. Eng. Sci.*, 74: 27-37.
- Chen, G., R. Shan, J. Shi and B. Yan, 2014. Ultrasonic-assisted production of biodiesel from transesterification of palm oil over ostrich eggshell-derived CaO catalysts. *Bioresour. Technol.*, 171: 428-432.
- Katikaneni, S.P. and M. Cheryan, 2002. Purification of fermentation-derived acetic acid by liquid-liquid extraction and esterification. *Ind. Eng. Chem. Res.*, 41: 2745-2752.
- Kirpalani, D.M. and F. Toll, 2002. Revealing the physicochemical mechanism for ultrasonic separation of alcohol-water mixtures. *J. Chem. Phys.*, 117: 3874-3877.
- Mahdi, T., A. Ahmad, A. Ripin and M.M. Nasef, 2014. Vapor-liquid equilibrium of ethanol/ethyl acetate mixture in ultrasonic intensified environment. *Korean J. Chem. Eng.*, 31: 875-880.
- Mahdi, T., A. Ahmad, A. Ripin, T.A.T. Abdullah and M.M. Nasef *et al.*, 2015. Mathematical modeling of a single stage ultrasonically assisted distillation process. *Ultrason. Sonochem.*, 24: 184-192.
- Mahdi, T., A. Ahmad, M.M. Nasef and A. Ripin, 2015. State-of-the-art technologies for separation of azeotropic mixtures. *Sep. Purif. Rev.*, 44: 308-330.

- Merouani, S., O. Hamdaoui, Y. Rezgui and M. Guemini, 2013. Effects of ultrasound frequency and acoustic amplitude on the size of sonochemically active bubbles-Theoretical study. *Ultrason. Sonochem.*, 20: 815-819.
- Modla, G. and P. Lang, 2008. Feasibility of new pressure swing batch distillation methods. *Chem. Eng. Sci.*, 63: 2856-2874.
- Nii, S., K. Matsuura, T. Fukazu, M. Toki and F. Kawaizumi, 2006. A novel method to separate organic compounds through ultrasonic atomization. *Chem. Eng. Res. Des.*, 84: 412-415.
- Ripin, A., S.K. Abdul Mudalip, Z. Sukaimi, R.M. Yunus and Z.A. Manan, 2009. Effects of ultrasonic waves on vapor-liquid equilibrium of an azeotropic mixture. *Sep. Sci. Technol.*, 44: 2707-2719.
- Sulaiman, A.Z., A. Ajit, R.M. Yunus and Y. Chisti, 2011. Ultrasound-assisted fermentation enhances bioethanol productivity. *Biochem. Eng. J.*, 54: 141-150.
- Zhou, D.W., D.Y. Liu, X.G. Hu and C.F. Ma, 2002. Effect of acoustic cavitation on boiling heat transfer. *Exp. Therm. Fluid Sci.*, 26: 931-938.