

Design and Implementation of a Predictive Control System for a Shake Table of Earthquake Simulator

¹Juan M. Chaparro, ²Oscar F. Aviles S and ¹Alonso De J. Chica L
¹Department of Electronics, Central University, Colombia, Bogota
²Department of Mechatronics, Militar Nueva Granada University, Colombia, Bogota

Abstract: This study presents design, implementation and performance testing of a predictive control system for a shake table used in earthquake simulation. The system is located in the Civil Engineering Laboratory at Andes University. The table allows to keep track on an earthquake profile expressed in horizontal displacement. However, for each case, the loads vary in terms of mass and flexibility of the structure to be tested. Therefore, it is required a strict control of these variations. Dynamic model approximate to the shake table expressed in function of transference from a strategy of identification using MATLAB® was obtained to create the design. Simulations were carried out at different seismic input and the responds of different preventing controllers designed were analyzed. Finally, the results obtained of predictive controllers operating the table under three different loads conditions are presented.

Key words: Mathematic model, shake table, earthquake, control system, predictive control, MATLAB

INTRODUCTION

Damages caused by earthquake are the result of factors such as earthquake magnitude, ground motion duration, type of soil and type of construction. Earthquakes cannot be avoided but the damage they may cause can be reduced with an appropriate design of the structures (Tintaya, 2007). In seismic activity regions, data acquisition of structural response during an earthquake is essential to evaluate the design and to develop new methods to analyse, design and fix the structural systems.

In the Colorado State University, Civil Engineering Professor, Dr. John Van de Lindt as a part of a project financed by the National Science Foundation NEESWood to develop protection systems, led a series of earthquakes in a seven-story condominium tower and a level of 12×18 m with one-and two-bedroom living units and 2 retail stores on the ground level. In June 2009, the tower was moved to the E-Defence (Earth Defence) earthquake platform in Japan. The building underwent three tests, from 6.7-7.5 magnitude earthquake (in comparison with 1994 Northridge, California whose earthquake was 6.7).

In Nevada, there is a simulation Earth Tremor Laboratory. This lab counts on three cylinder that manage (50 tons, 450 kN) biaxials that allow to shake the operating table. Manufactured by MTS, each table has a dimension of 14×14.6 ft (4.3×4.5 m). An acceleration of 1 g under its 50 tons of capacity (450 kN) can be reached. To reach

these maximums, there are two accumulator banks to manage the cylinders. It presents a horizontal and vertical acceleration of 20 m/sec². Altogether, it counts on three biaxials tables that are placed to act together as one table or can be managed individually.

Enterprise-level, the company quanser presents the shake table XY shake Table III. This table features that it can be set according to the dynamic of the desirable study. The capacity of the system is 0.5 tons with displacement in two dimensions of ±21.59 cm. Academic level, it also presents the quanser tables, shake Table I and II of displacement lower than 10 cm in a dimension and capacity up to 30 kg (Fig. 1).

In Colombia, the laboratory of the Civil Engineering Department of the Andes University counts on a shake table to simulate tremors which is moved by a hydraulic servo. Up to the date of this research, it is the only one in Latin-American. Its design was done by engineers from

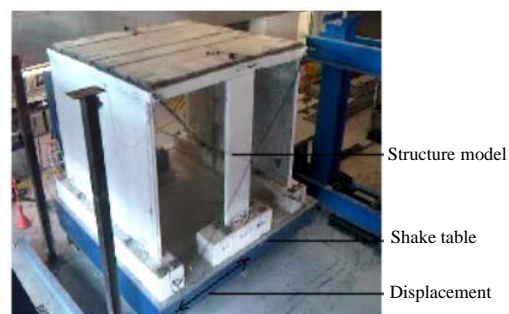

Fig. 1: Shake table III system with structural model

the same department. It might have longitudinal motion in a dimension of up to 30 cm in both directions which is the maximum displacement that has been registered in an earth tremor. The shake table weights 5 tons and has a dimension of 5.5 m long by 4.2 m wide and a capacity of up to 15 tons.

At first, the table was managed manually modifying the input voltage at operating with inadequate results, therefore, it was required a control system that guaranteed after shock of earthquakes of reference, so that, it was easy to analyse and compare properly (Bautista *et al.*, 2008).

MATERIALS AND METHODS

Theoretical framework

Seismic signals: In an earthquake, it can be identified the hypocenter or deep inner zone where the earthquake rupture starts, the epicenter area of the surface perpendicular to the hypocenter where the seismic waves have greater impact (Sarria, 1987; Garcia, 1997; Chopra, 2007). The earth tremor propagates through elastic waves (similar to the sound), from the hypocenter. To carry out this research, the bandwidth of seismic signals used is found between 0.3-3.2 Hz approximately. The features of the seismic signals used are presented in Table 1.

Different seismic signals of reference are used for the tests that were done. The bandwidth of these signals is between 0.1 and 3.2 Hz approximately. The seismic signal that were used the most at the lab of the Andes University are referenced in the Table 1. These earthquakes were chosen because of the serious damage they caused on buildings.

Modelling of the system

Physical constitution of the system: The system consists of a set of devices that aim at moving a table which supports a structure or model (scale-building or in some cases they are real) in an identical manner of a seismic signal applied to the input. This means that the structure will be submitted to dynamic situations similar to those the real building will be when it is built. The whole system is illustrated in the Fig. 2.

The physical system consists of the following mechanisms: hydraulic cylinder, proportional valve, limit pressure valve, hydraulic pump, displacement sensor, a table on which models of 5 tons are placed and with a capacity to move up to 15 tons and structural models from 2.5-5 tons maximum. The control block corresponds to the location, the compensators and controllers designed that were implemented in the computer are placed within the

Table 1: Earthquakes used for the system tests

Earthquake	Station	Date	Sample	bandwidth
Umbria	Pietralung, Italy	29 April, 1984	0.01 s	0.5-2 Hz.
Mammoth Lake	Long Valley, USA	26 May, 1980	0.02 s	0.5-3.2 Hz.

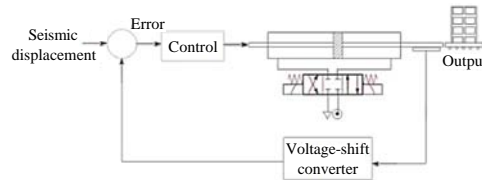

Fig. 2: Constitution of control system for a shake table

system. For obtaining and distributions of data NI 9205 and 9263 cards were used from the national instruments with interface to a compact DAQ.

The servo-valve used is from the brand MOOG serial D791 and D792. They are three way flow valves and 4 operating modes. The hydraulic cylinder is 1.80 m long, its diameter is 20 cm and its displacement is 60 cm. The system has a magnetostrictive sensor of serial MAZ to measure table displacement. The sensor is lineal (see datasheet) and is connected to the actuator in which piston displacement is taken.

Supply and recirculation of hydraulic fluid source consists of a hydraulic pump controlled by air that feeds an accumulator or lung. The hydraulic part consists of a variable speed constant pressure pump of 400 psi. It pumps 76 gal/min. There is only one pump. It also has 20 accumulators of 50 lt. The flow reaches a MOOG D792 valve. The flow is limited by the system. The limit is 1000 L/min.

Mathematical modelling of the shake table system: A mathematical modelling of the components of the system has to do with establishments of the equations that its dynamic presents in two main aspects: structural model table interaction description in which were used the equations proposed by Rondon and Chio (2010) related to the dynamic model table and the formulations proposed to describe the behaviour of the servo-hydraulic mechanisms controlled which are taken from Negri (2001). These equations allowed establishing a theoretical transfer function approximate to fifth order.

The research done focused on obtaining experimentally the mathematical model of the system (Clark *et al.*, 1987). This mathematical model is obtained by configuring the closed-loop with an additional filter that was designed to eliminate dc levels. This configuration was proposed in order to avoid the natural derivative of the system in open-loop as effect of the integral behaviour of the plant. The open-loop system

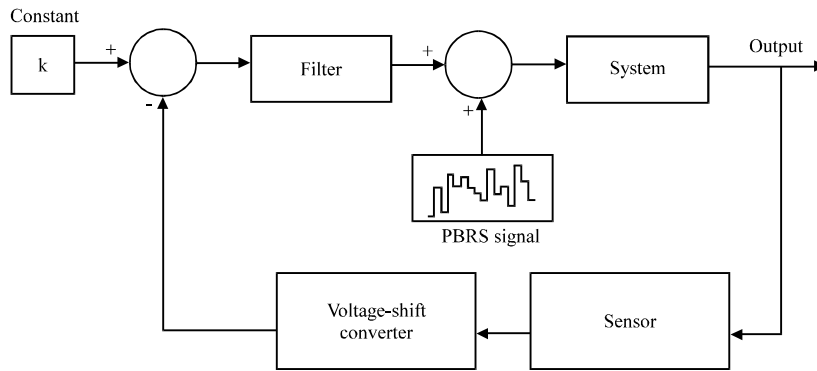

Fig. 3: Diagram of blocks for shake table system identification

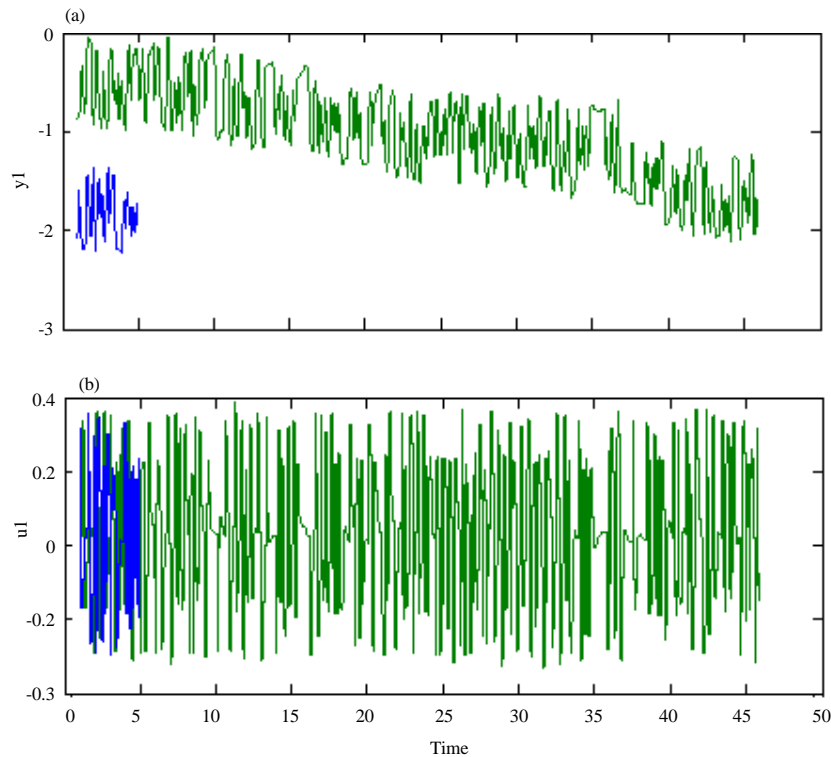

Fig. 4: Input and output signals for shake table system identification

can be observed in Fig. 3. To do this, data were taken through a program developed in labview® designed for such purpose and the identification and obtaining the mathematical model using the ident tool from MATLAB®.

For system identification, several experiments were carried out changing the PRBS signal amplitude and the time application sample. For the identification, it was taken the signal applied to the servo-valve and the signal sent by the magnetostrictive sensor. The signals obtained are observed in Fig. 4, of green colour where Y_1 correspond to the table displacement and μ_1 to the signal applied in the servo-valve.

The best transfer function from system $G(z)$ obtained without load, based on the results of the simulations performed and what was expected from:

$$G(z) = \frac{0.864z^4 - 0.717z^3 - 0.5512z^2 + 0.4275z}{z^5 - 1.8244z^4 + 0.2562z^3 + 0.8716z^2 - 0.1959z - 0.1075} \quad (1)$$

Comparing the real data with the ones obtained by simulation, it validates the model obtained without load as it is observed in Fig. 5.

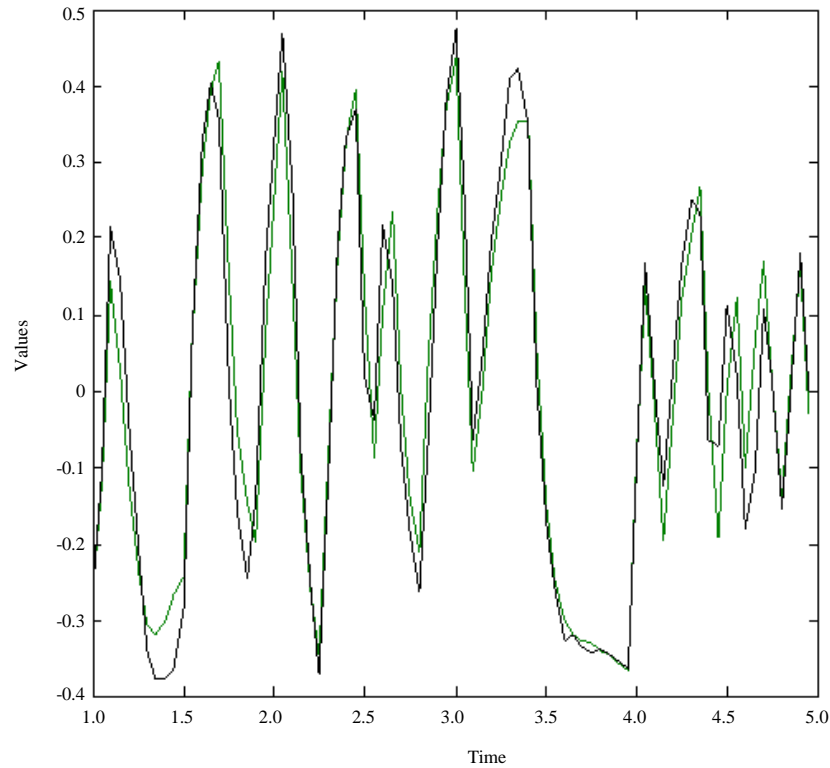

Fig. 5: Real data and obtained from the simulation

RESULTS AND DISCUSSION

Design of controllers

Frequency compensator: On the transfer function $G(z)$, it was used the tool RI tool from MATLAB® for simulations of simple controllers and make the first tests for a better system understanding and its features including its behaviour in frequency. From these simulations, it appeared that a crucial part of the research is to obtain the bandwidth required to replicate the seismic signals inside the closed loop.

In Fig. 6, it is observed the response to unit step signal and the frequency response of the system in presence of a proportional controller. In this sense, the system bandwidth was determined (6 Hz approximately), to identify the possible attenuation of frequencies present in the seismic signal applied.

A first compensator frequency designed searched an increase on the system bandwidth. The compensator obtained was:

$$\frac{U(z)}{E(z)} = 0, \frac{8962z}{z^2 + 0.5z + 0.0625} \quad (2)$$

Where:

$U(z)$ = The output of the compensator

$E(z)$ = The system error signal

The diagram of blocks of simulated system is shown in Fig. 7. The response obtained from the simulated system is shown in Fig. 8. The seism block corresponds to the signal applied from a file in which data are applied to the system. The constant block 30 corresponds to a value that allows the data file is treated as the offset values of the vibrating table. The blocks of saturation are configured to simulate the displacement of the vibrating table from 0-60 cm and the input signal to the vibrating table. It is observed that there are major differences between the seismic signal applied and the output of the system in amplitude but there is a slight phase lag.

The implementation of the compensator frequency was done through its equation of differences in LabVIEW with sampling time of $T = 0.05$ seg:

$$u(k) = 0.8962e(k-1) - 0.0625u(k-2) \quad (3)$$

In tests with the physical system, the strong pulses were observed at the beginning of the seismic signal with a slight error in the response obtained in the simulation. One of the response obtained is observed in Fig. 9 with Mammoth Lake seismic signal.

The curve of greater amplitude corresponds to the system response obtained with the compensator obtained. At some instants of time it is observed that

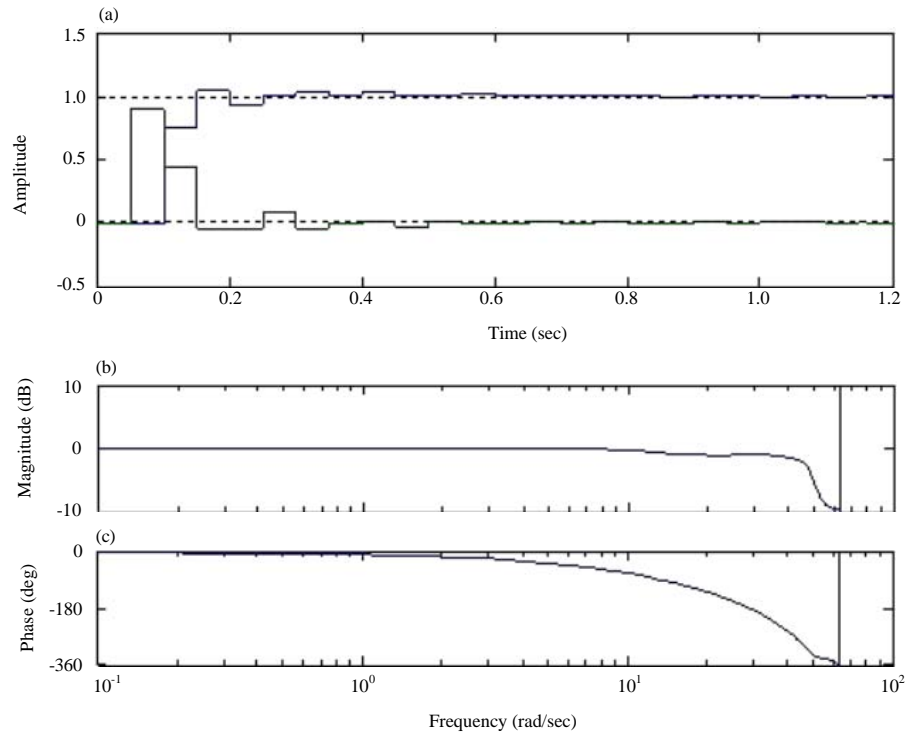

Fig. 6: Response time and frequency of the system to a step signal

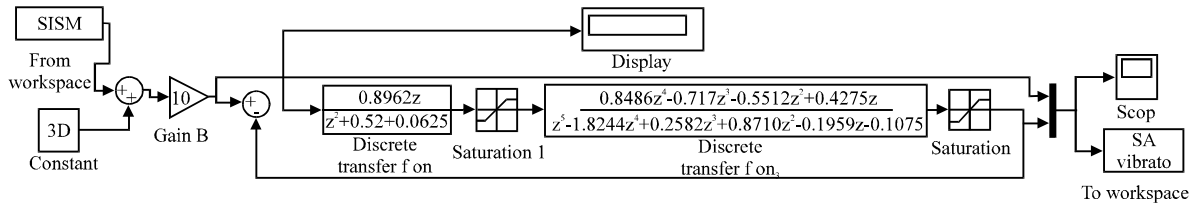

Fig. 7: Diagram of blocks for compensator frequency system simulation

there is a phase lag between the signals and an under-damped signal before the seismic signal is applied. The system achieves to track the signal partially.

In Fig. 10, it is presented the frequency spectrum corresponding to the seismic signal and the output obtained corresponding to the greater amplitude.

There is a significant difference in the very low frequencies. For the frequency from 0.7-2 kHz, it can be noticed that the output displacement signal spectrum amplitudes are higher than seismic signal spectrum applied to the system. This situation may be possible due to the system having only one integrator which allows to track steps without asymptotic standard error but no other profiles.

Modifications were made to the compensator design and new proposals for controllers were made but the effect of this problem could not be decreased.

Predictive controller

Design and controller simulation: Bearing in mind the

different difficulties presented in the system regarding the implementation of the previous compensator, a new controller whose signal applied tracking system was more appropriate was searched. In this sense, it was needed a more adequate controller that could take into account the following.

Anticipated knowledge of the complete earthquake profile. Inclusion of restriction both output variable values (displacement) and values applied for operating the actuator (servo-valve voltage). This is to guarantee plant operation was restricted. This will guarantee stability. Robustness to deal with mass changing and flexibility of the structures to be tested. Low sensitivity to noise measurement.

A controlling strategy close to the above considerations is the Generalized Predictive Controller (GPC) (Tintaya, 2007; Saad and Duque, 1987). Its design started from the identified model system. On this model, routines developed on MATLAB are use for obtaining

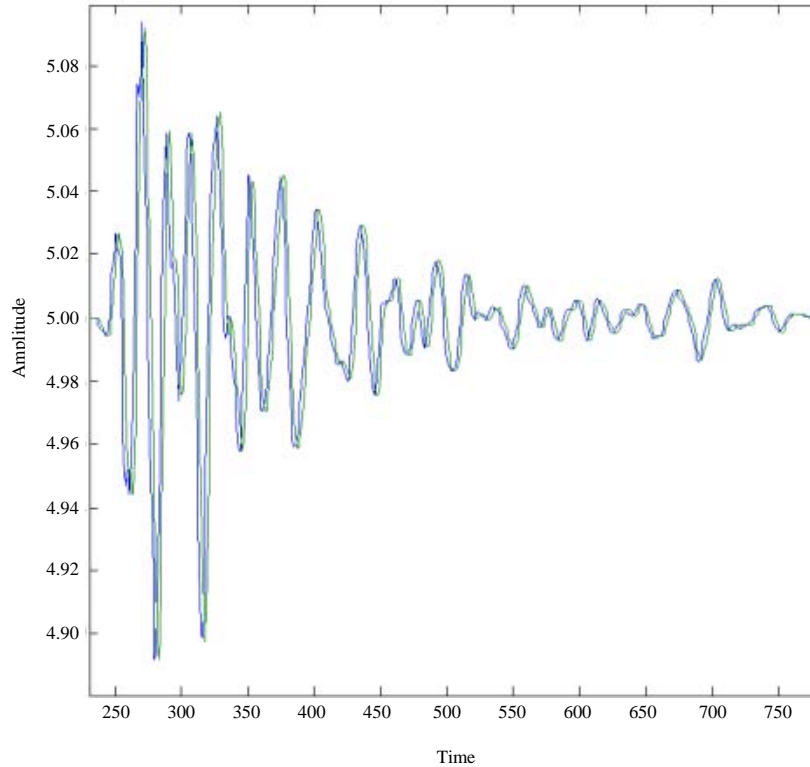

Fig. 8: Seismic signal applied and system response

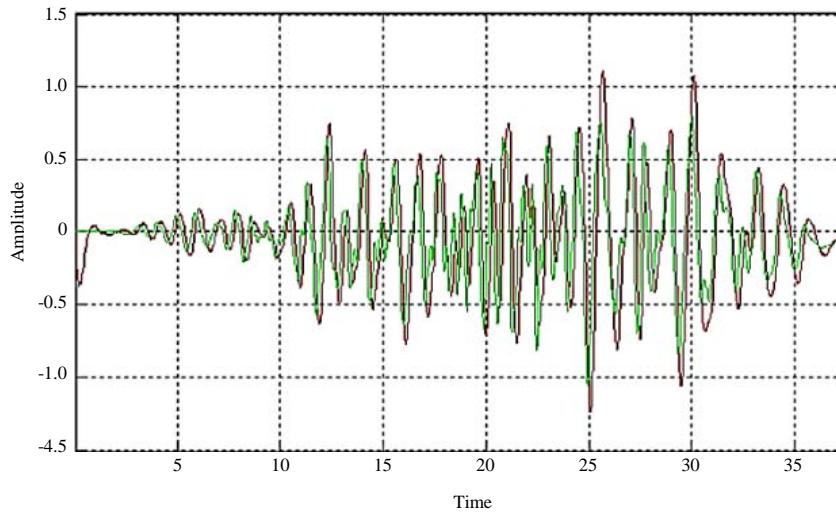

Fig. 9: Response to the seismic signal system applied. First test

the predictive controller. From data presented, calculations are done for W (anticipation), S (cascade) and R (feedback), respectively which form the controller and from which some adjustment were made according to the simulation obtained in Simulink, given the following polynomials:

$$\begin{aligned}
 w &= 1.0504 \\
 R &= 2.0561 - 0.3904z^{-1} - \\
 &0.9741z^{-2} - 0.2359z^{-3} + 0.1229z^{-4} \\
 s &= 1 - 0.5z^{-1} - 0.5z^{-2} + 0.5z^{-3}
 \end{aligned} \tag{4}$$

In Fig. 11, it is presented the system blocks diagram for simulation corresponding to Umbria seismic signal.

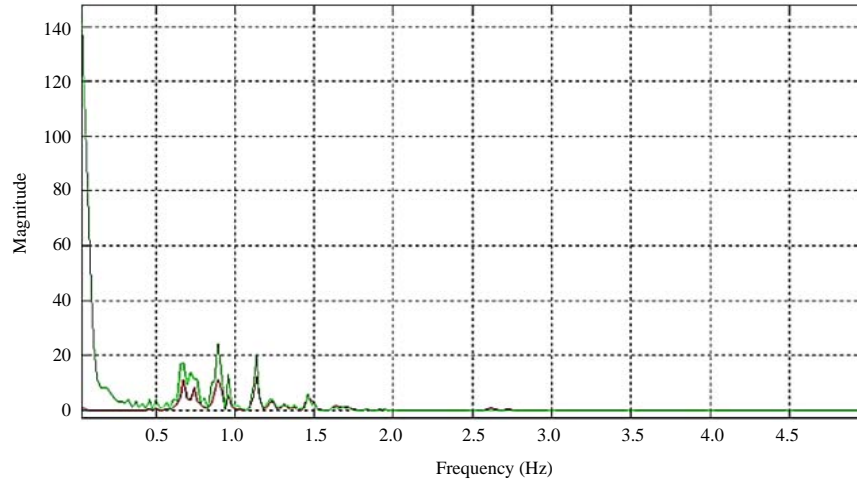

Fig. 10: Frequency spectrum for the seismic signal applied and the response obtained. First test

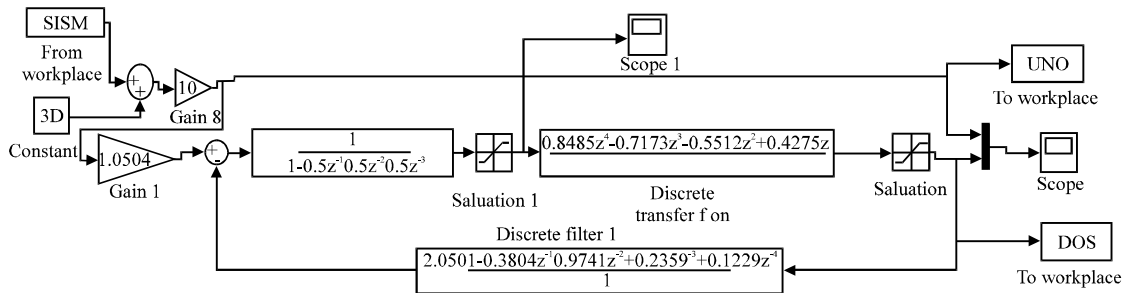

Fig. 11: Diagram of blocks system with predictive controller

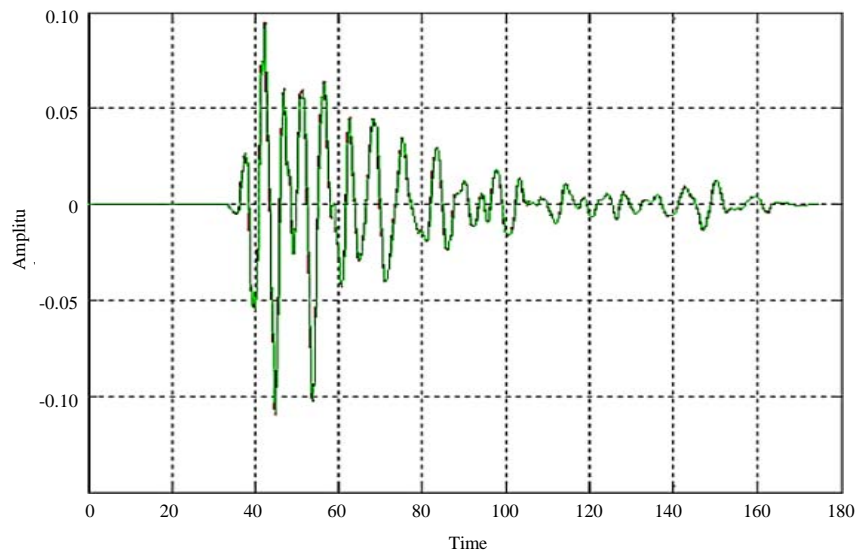

Fig. 12: Response obtained from the system with predictive controller

The simulation obtained is observed in Fig. 12. It can be observed that the signals are very similar having a good tracking control of the input.

Looking at the frequency spectrum presented in Fig. 13, it is observed that there are slight differences in magnitude for some frequencies.

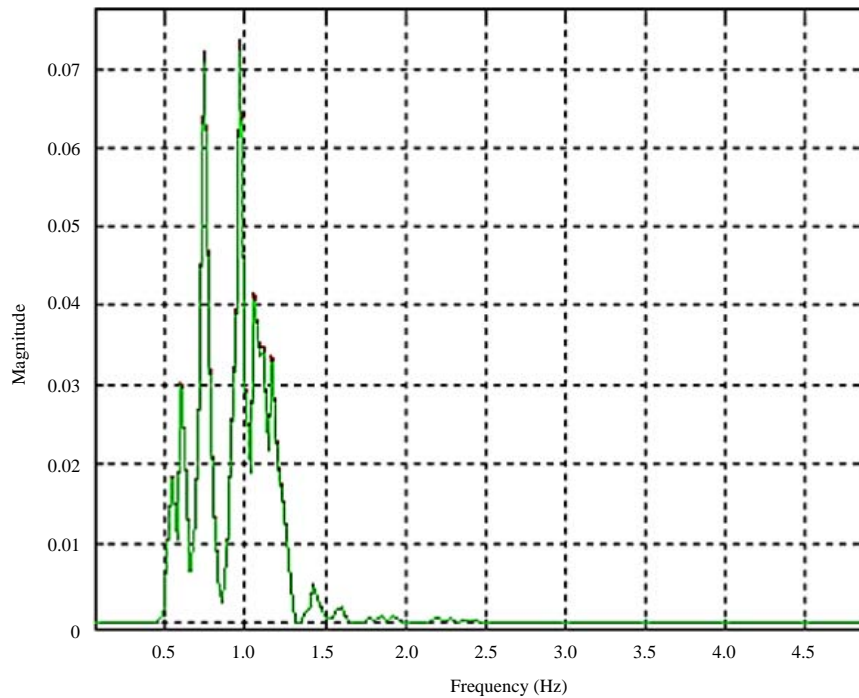

Fig. 13: Magnitude spectrum in system frequency for seismic signal applied and the output obtained

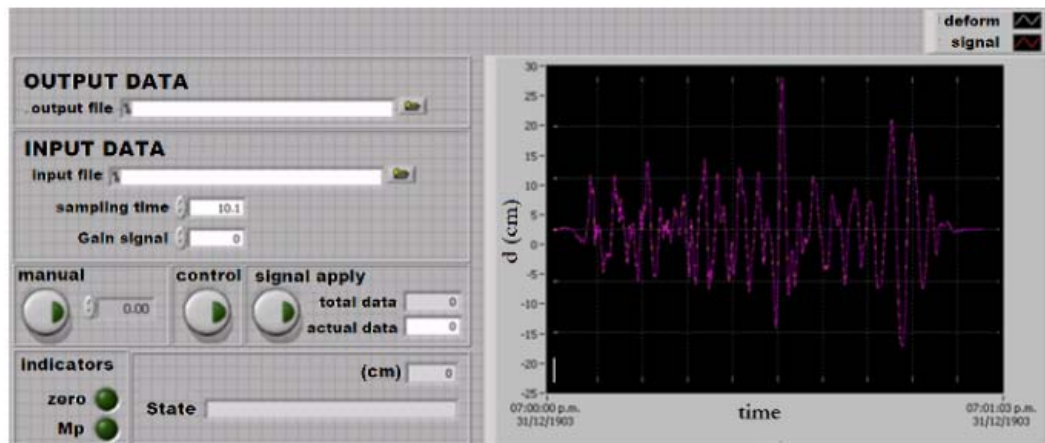

Fig. 14: Graphic user interface in labview

With the Mammoth Lake seismic signal, new simulations were done for the predictive control system. The differences in the frequency spectrum were presented on the peaks of the highest magnitude frequencies. System temporary response showed that the signals present some differences especially in the bigger displacement in which desirable value cannot be reached. Despite this, 95% signal applied tracking was obtained.

Control system implementation: To program the control system, the LabVIEW® was used as it is easy to program

through graphic user interface (Fig. 14) which also, communicates with compact DAQ cards reference 9205 and 9263.

Control system physical test of shake table

Tests done on the shake table without structural model (load): From the tests done, appropriate parameters were selected from predictive control GPC (horizon control, control variation and prediction). Particularly, the prediction horizon was selected based on 5 steps. Optimization algorithm of GPC regulator produces a polynomial version

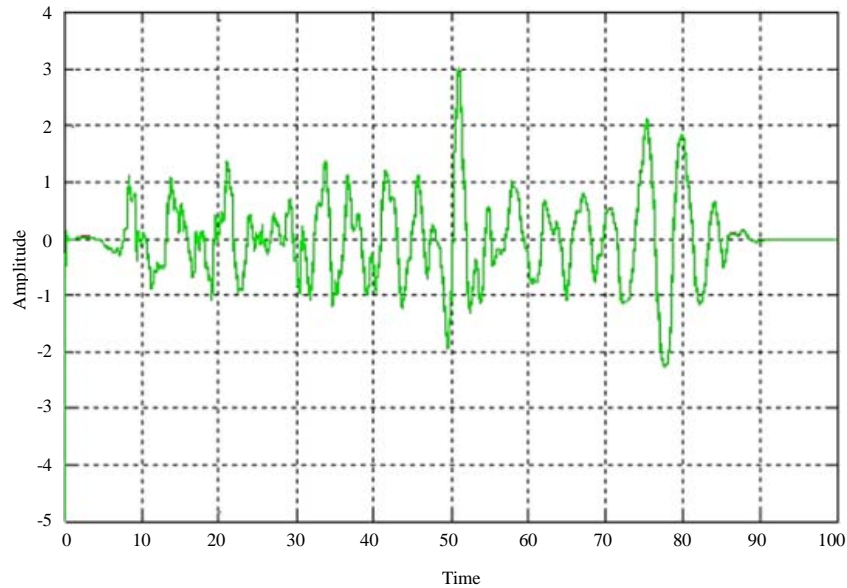

Fig. 15: System response with Umbria earthquake and the signal obtained from the real system

for the implementation represented in three polynomials (anticipation (W), cascade (S) and Feedback (R)):

$$\begin{aligned} w &= 1.4612 \\ R &= 2.27 - 1.2325z^{-1} - 0.5908z^{-2} + \\ &1.1828z^{-3} - 0.0495z^{-4} - 0.1188z^{-5} \\ s &= 1 + 0.5z^{-1} + 0.5z^{-2} - 0.55z^{-3} \end{aligned} \quad (5)$$

The input signal applied corresponded to a strong displacement tremor and 100% amplitude (as data was given by the Civil Engineering Department from Andes University). In this test, it was observed that the system responded quite well as no major differences were observed between the signal applied and the table displacement signal (Fig. 15). The same occurs with the frequency spectrum (Fig. 16).

The second Mammoth Lake seismic signal was applied to the system where Fig. 17 response was obtained. In the response it is observed that temporary signals are very similar especially when the seismic signal is applied.

Looking at the frequency spectrum in Fig. 18, it can be noticed that there are a few differences located in frequencies from 2.5-3 Hz. The simulation diagram used is observed in the Fig. 19.

Tests carried out on shake table with structural model:
The test physical structure (house) consisted of concrete

foundation and ceiling and “guadua” walls which make the structure a little more flexible. It weighted 4 tons approximately. Next, it is presented the response obtained from the system to the earthquake called “CENTRO” that took place in California in 1994.

Observing the Fig. 20, it can be pointed out that a good tracking is done and only in some great amplitude it can be observed some differences between the desirable signal and the one achieved. This could be due to own limitation of the system on its components and to the operation that seems no to respond as quickly as it is required (velocity limitations).

Analysis of the frequency spectrum of seismic input signal and the response obtained is presented in the Fig. 21. It is important to clarify that the spectrum corresponds to displacement and not to acceleration (overall, it is displacement profile what is tracked in these tests).

In the frequency spectrum, differences in great amplitude frequencies are verified. However, the response is appropriate for seismic test needs.

Discrete compensator frequency presented an acceptable behaviour in the simulations run. However, when they were implemented in the physical system the desirable responses were not obtained as amplitudes sought in the seismic signal were not achieved. This is due to system incapability to keep the desirable track.

The previous situation led to propose predictive controller design. Firstly, the design was created with a

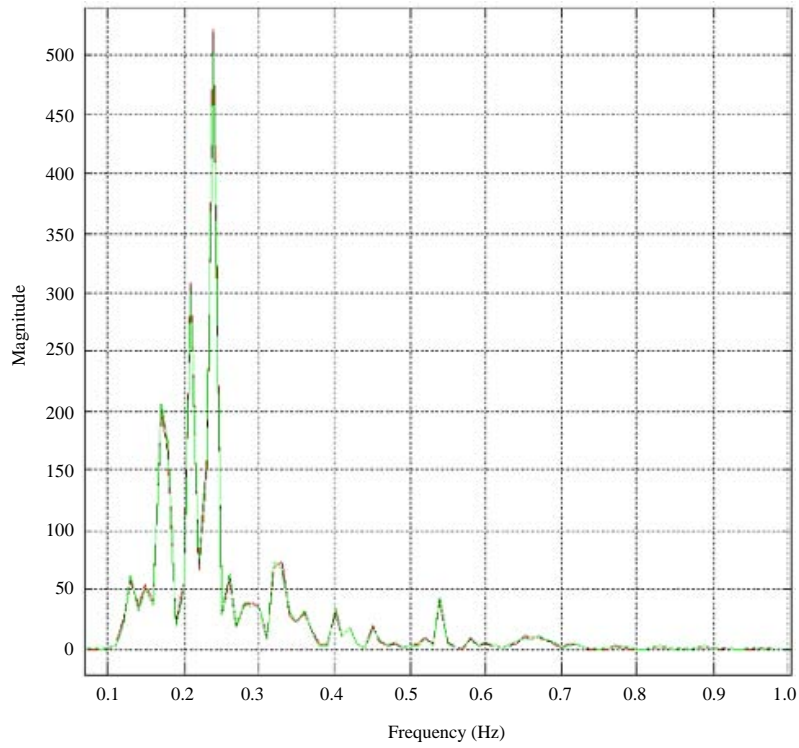

Fig. 16: Frequency spectrum of Umbria seismic signal and signal obtained from the system

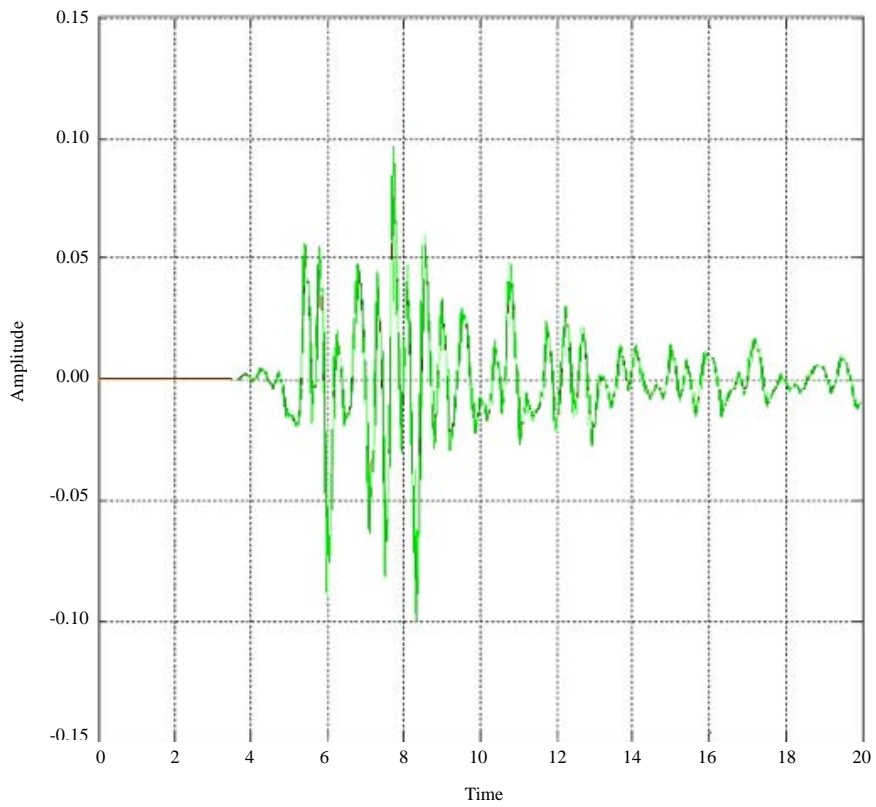

Fig. 17: System response with mammoth lake earthquake and signal obtained of the real system

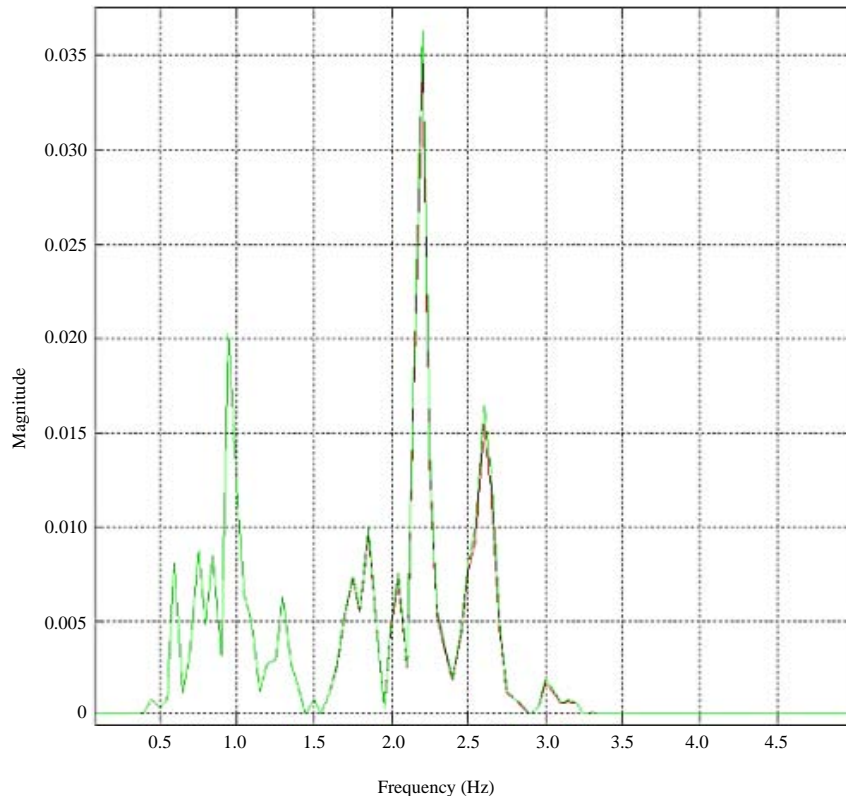

Fig. 18: Frequency spectrum of mammoth lake seismic signal and signal obtained from the real system

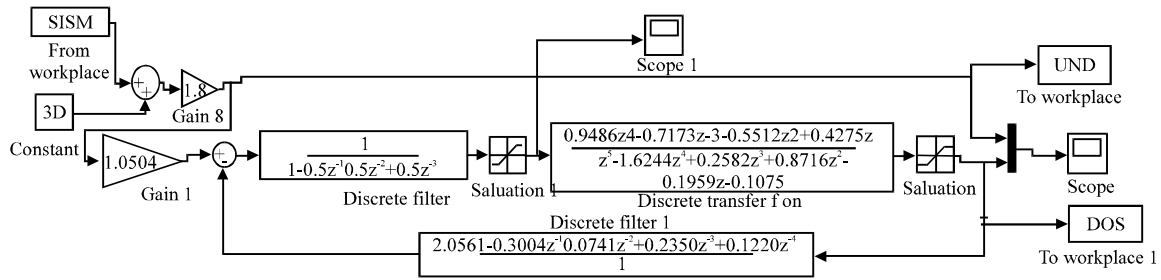

Fig. 19: System simulation with mammoth lake earthquake and predictive controller

horizon $n = 2$ which presented pretty good results overcoming compensator frequency results and keeping better track of the signals applied. However, it had some difficulties such as in the greater amplitudes with slope changing did not have good tracking therefore, predictive horizon was changed to controller.

With the change of predictive horizon to $n = 5$, the system improved substantially and the tracking issue decreased considerably reaching almost all high amplitude points. There were some changes in seismic signals applied, changes in amplitude scale in every single one of them and the system behaved the same. Different mass

structural models were placed and the system kept behaving the same way well tracking the signal applied.

The test with the physical system carried out without structural model (load) corresponding to the shake table without mass on it and with structural model corresponding to having a mass above 2.5 and 5 tons as one floor house and two floor house made of concrete and guadua walls. In both cases, they are considered rigid structure which lead to run test on more flexible structures in the future.

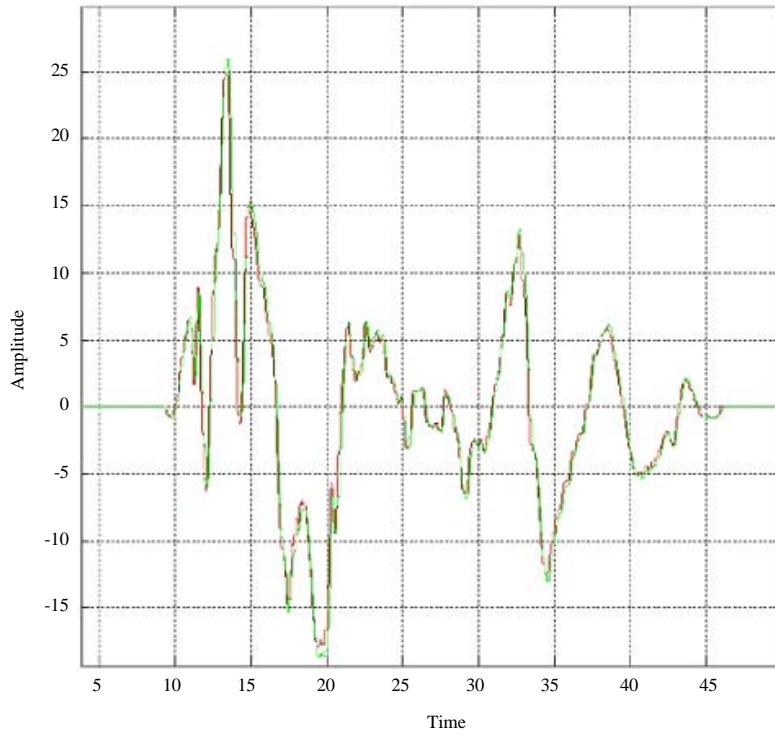

Fig. 20: System response with centro earthquake and signal obtained from the real system

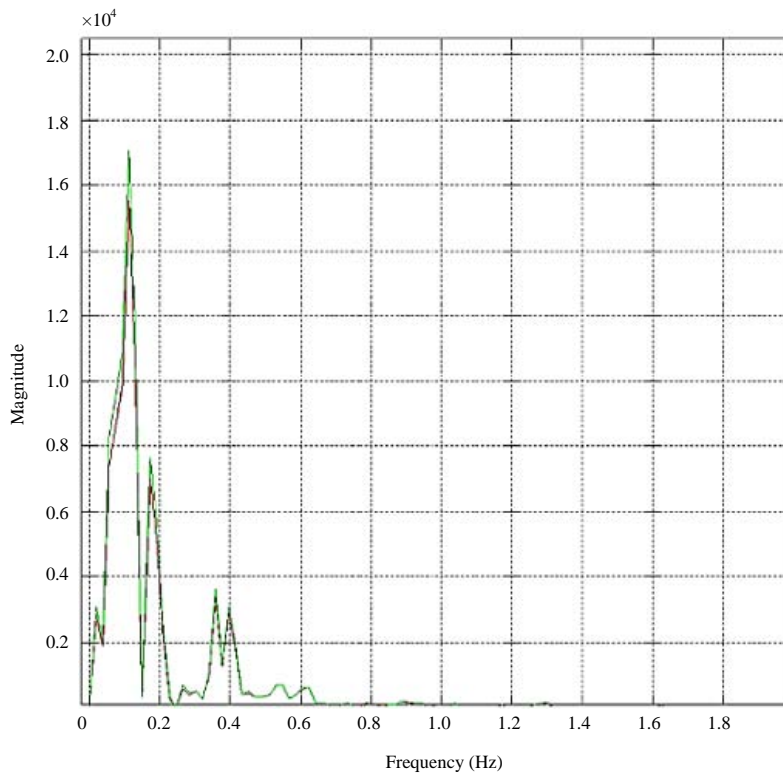

Fig. 21: Frequency signal of centro earthquake signal and signal obtained from the real system

CONCLUSION

The discrete compensators such as the frequency and the predictive controller had good performance in simulation. This allowed to conclude that the significant factor for a great system performance is to have the capability to take future data and to anticipate. In this sense, when running physical tests with shake table system, it was found that the predictive controller fulfil this requirement because it has a better tracking response system to signal applied.

The criteria used for a predictive controller design were based on the behaviour on a future horizon in time, so that, effects on reference constant changes could be anticipated and removed before they enter the system. Inclusion of restrictions both output variable value and input variable values (actuators).

Responses of every simulation were analysed, discrete compensator frequency as well as the predictive controller. From this analysis, predictive controllers amazing features stood out to improve temporary and frequency system behaviour with respect to reference signal applied.

Tests run on physical system, showed that without a structural model (load) or with a structural model (house based on guadua), the control system behaved in a similar way keeping track, highly accurate, on the seismic signal.

RECOMMENDATIONS

As a future work it will be quite interesting to analyse the system with a more flexible body with elastic properties. This raises other interests such as damping effects and elasticity between mass and other type of structural model with elastic features

ACKNOWLEDGEMENT

This research was supported by the Maxwell Research Group of Central University and Davinci Research Group of Militar Nueva Granada University in Bogota, Colombia.

REFERENCES

- Bautista, L.A., R.C. Hernandez and E.B. Uruena, 2008. [Shaking table for unidirectional seismic simulation vibratory table for the simulation of seismic movements in one direction (In Spanish)]. *Colomb. Mag. Adv. Technol.*, 1: 56-65.
- Chopra, K.A., 2007. *Dynamics of Structures, Theory and Applications to Earthquake Engineering*. 3rd Edn., Prentice Hall, Upper Saddle River, New Jersey, USA., ISBN:978-81-317-1329-7, Pages: 914.
- Clarke, D.W., C. Mohtadi and P.S. Tuffs, 1987. Generalized predictive control-Part I. The basic algorithm. *Automatica*, 23: 137-148.
- Duque, M. and A. Gauthier, 1999. [Computer Control: Control of Continuous Processes using a Digital System]. University of Los Andes, Bogota, Colombia, (In Spanish).
- Garcia, L.E., 1997. [Structural Dynamics Applied to Seismic Design]. University of Los Andes, Bogota, Colombia, (In Spanish).
- Negri, D.V., 2001. [Hydraulic and Pneumatic Systems for Automation and Control]. Marcos de Noronha, Florianopolis, Brazil, (In Portuguese).
- Rondon, M.E. and C.G. Chio, 2010. [Structural Dynamics]. Industrial University of Santander, Bucaramanga, Colombia, Pages: 202 (In Spanish).
- Saad, M. and M. Duque, 1987. *A Multivariable Performance-Oriented Adaptive Generalized Predictive Controller*. 10th Edn., IFAC, Munich, Germany,.
- Sarria, A., 1987. [Introduction to Geophysical Methods in Civil Engineering]. University of Los Andes, Bogota, Colombia, (In Spanish).
- Tintaya, C.O.J., 2007. [Digital processing of seismic signals with Matlab (In Spanish)]. *Rev. Investigacion Fisica*, 10: 45-50.