

Intelligent Auto Traffic Signal Controller for Emergency Vehicle by Using Wireless Sensor Network

Arshad Ali

Faculty of Computer and Information Systems, The Islamic University of Madinah,
Prince Naif Ibn Abdulaziz Road, 42351 Al Madinah Al Munawarah, Saudi Arabia

Abstract: The prime objective of this project is to design wireless sensor based traffic signal control system for the uninterrupted movement of emergency vehicles. Emergency vehicles such as ambulances, fire fighting vehicles and police force vehicles are required to reach their destination as quickly as possible. Traffic congestion is one of the major problem to be considered. Generally vehicular traffic intersects at the junctions of the road and are controlled by the traffic signals. Traffic signals need a good coordination and control to ensure the smooth and safe flow of the vehicular traffic. During the rush hours, the traffic on the roads is at its peak. Due to the congestion, there is a possibility for the emergency vehicles to be strucked in the traffic jam. To solve this problem, the wireless sensor based signals needed which detect the movement of emergency vehicles and ensure the uninterrupted movement. Hence, I propose a wireless sensor based smart traffic signal in this research project. In this project I will try to minimize the possibilities of traffic jams, caused by the traffic lights, to some extent by clearing the road with higher density of vehicles and also provides the clearance for the emergency vehicle if any. The system will be based on the smart sensors and signal controller which ensure the smooth movement of emergency vehicles.

Key words: Sensor, signal system, emergency vehicle, nodes, congestion, wireless sensor

INTRODUCTION

Congestion is increasing day by day and preemption of emergency vehicles have become a necessary concept in today's life. Traffic in city squares and traffic emergencies are one of the biggest problems of the society. You should use this handle in an efficient manner, to realize for emergency vehicles to pass the emergency and the need for thorough. Traffic monitoring and controlling is a difficult task. The aim of the traffic research is to optimize the flow of vehicular traffic and goods. The flow of the traffic constantly changes depending on the time of the day, day of the week and time of the year. At times, road work and accidents further influence the complexity. Hence, traffic light optimization is a complicated process. Even for single junctions there might be no obvious solution and the problem becomes even more complex for the multiple junctions, as the state of one light in one junction directly influences the flow of traffic towards many other lights.

With the ever increasing vehicles on the road and the number of road users, the limited resources provided by current infrastructure lead to ever increasing travelling times. Hence, an intelligent control of traffic is an important issue to be considered. The traffic monitoring authority need to find new methods of overcoming this

problem like construction of new roads, flyovers etc. and also development of sophisticated traffic monitoring and control systems. One way to improve the traffic flow and safety of the current transportation system is to apply automation and intelligent control methods to roadside infrastructure and vehicles (Fig. 1).

In the proposed work, some junctions in the way of the emergency vehicle are to be discussed and bring into focus along with the use of the wireless sensor networks. Due to heavy traffic jam emergency vehicles face hardship when the vehicle pass from junctions. On the basis of WSN, traffic control systems of junctions will able to minimizes the traffic and thus assigns the right time for red and green lights to glow, so that, the emergency vehicles can pass easily. A WSN is used as a tool instrument and control the traffic signals. In case of emergency and quick response to the scene, it is very difficult for the cross ponding vehicles to arrive on time to the destination due to the congestion on the road because of huge traffic on the street. Due to this reason lot of patient lost their life before reaching to hospital for the treatment and police cars also not arrived to the scene on time due to congestion on the road, etc. Due to the congestion thousands of people lost their life because they don't get treatment on time and so. By implementing this research work in real life successfully, we can make the smooth

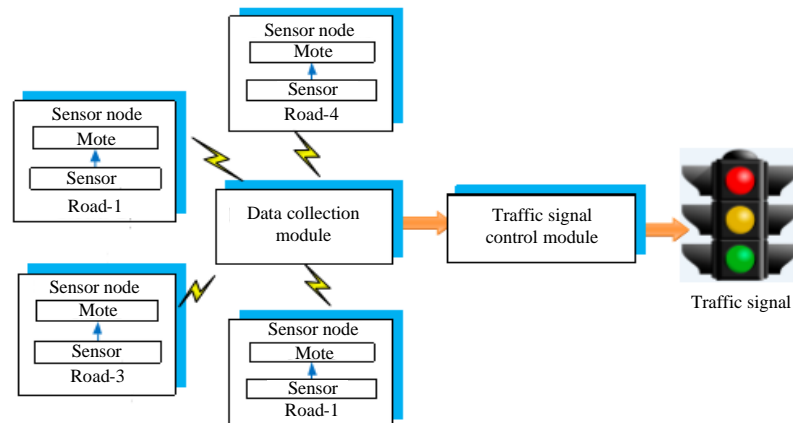

Fig. 1: Traffic signal controller module

movement of the emergency vehicles and can save the lives of people and reduce the response time in case of emergency.

Background study: To overcome this problem traffic control agencies need to find new ways such as the construction of new roads, bridges and other means. One way to solve this problem is to use the automation and intelligent control system to monitor the traffic flow and the safety of the current transport system.

Vidhya and Banu (2014) proposed a density based traffic signal system which changes the signal timings automatically by sensing the traffic density at the junctions. In major cities, the traffic signal timing allotted are fixed. The research mainly aims to control the traffic signal by capturing the image and then converting them into the grayscale image and then to the threshold image. The contour image helps to count the number of vehicles present in the junction. The output screen shows the numbers of vehicles present at the junction and the green signal will glow based on the traffic density. They analyzed the image sequence and then estimate traffic congestion and finally predict the traffic light timings. Raspberry pi microcontroller is used to sense the traffic density and provides the signal timings.

Sinhmar (2012) proposed an intelligent traffic light and density control using IR sensors and microcontroller which optimizes the traffic light control using microcontroller. The microcontroller used in this research is 89451RD2 which is MCS51 family based. IR transmitter and IR receiver is placed on either side of the road. When a vehicle is passed on a road between IR transmitter and IR receiver, the IR system automatically gets activated and counts the number of vehicles present and store in its memory. Based on the vehicles count the microcontroller takes decision for traffic signal timings. In their research

they proposed, first to take input or image from the vehicles or object. Second is to process the given input by microcontroller to the computer and then finally it displays the traffic light control using closed loop system.

Their future research can be used to inform the people about various traffic conditions at different places and also transferring the data between the microcontroller and computer using telephone network and the data cell activated through sim.

Hussian *et al.* (2013) proposed WSN applications: automated intelligent traffic control system using sensors. This research is proposed to sense the traffic availability in the circle or junction and then regulate the traffic in a systematic manner. Most of the researches comprises of image processing technique which is more expensive and complex. This proposed system consists of three components namely, sensor nodes or motes, power source and microcontroller. This system is used to sense the vehicles using wireless sensor networks and a microcontroller based algorithm is used for traffic management. The wireless sensor nodes are placed at the junction to make it easy at high density of vehicles.

Goel *et al.* (2012) proposed intelligent traffic light system to prioritized emergency purpose vehicles based on wireless sensor network. In their research they propose an adaptive traffic intersection system based on wireless sensor network where the traffic light of one intersection can communicate with the traffic light of the next neighboring intersections and traffic clearance will be prioritized for special vehicles with the help of sensors. Their proposed method is used to minimize the average waiting time, then maximizes the average number of vehicles passing through intersection and finally minimizes the accidents.

Yousef *et al.* (2010) proposed an intelligent traffic light flow control system using wireless sensors networks. This study is mainly focusing on managing the traffic light control efficiently and utilizes the system design. An adaptive traffic control system using wireless sensor networks are dynamically used for both single and multiple intersection to control the traffic conditions. Their research contains Traffic System Communication Algorithm (TSCA) and the Traffic Signals Time Manipulation Algorithm (TSTMA), both the algorithms are used for efficient traffic control by the dynamic changes in the traffic signals. In single intersection, traffic congestion can be solved by calculating average waiting time and average queue length whereas an efficient traffic flow control globally on multiple intersection.

Shruthi and Vinodha (2012) proposed a priority based traffic lights controller using wireless sensor networks. This paper is mainly focusing on managing the traffic light control efficiently and utilizes the system design. An adaptive traffic control system using wireless sensor networks are dynamically used for both single and multiple intersection to control the traffic conditions. This research mainly designed to control the traffic over multiple intersections. This proposed system focus on emergency vehicles.

In another research work, the researchers developed a cost effective system using Radio Frequency Identification (RFID) technology and latest high speed micro controller (Avzekar and Moon, 2014) to achieve the desired results. The researchers proposed system which is compiled by using High-tech C compiler (Viswanathan and Santhanam, 2013) and circuit making is done through Proteus Software.

The existing systems focuses on the problem of adaptive traffic light control uses real-time traffic information collected by a Wireless Sensor Network

(WSN) sequence and length of traffic lights and then accordingly the traffic will be detected. This algorithm considers a number of factors such as traffic volume, waiting time, vehicle density, etc., after which green light sequence will be determined. Intelligent Transportation Systems (ITSs) are automatic road traffic management systems that manage road traffic with the intention of improving traffic safety and minimizing the energy consumption of vehicles running on the roads. An ITS consists of four subsystems, a surveillance system, a communication system, an energy efficiency system and a traffic light control (Fig. 2).

Proposed algorithm: The proposed algorithm is tested by using simulation techniques and the result are very much satisfied. In the tested simulation work some kilometer road was assumed with various intersection on the road in the way of the emergency vehicle up to destination. The vehicles are using sensor system which is connected with central control system of the signal in that particular way. The proposed algorithm is simulated by using the system pre-emption technique. Traffic pre-emption is a system that gives priority to emergency vehicles depending on the location or the direction in which they are heading (Fig. 3).

The speed and various other parameters are gathered from sensors mounted on traffic signals. Upon detecting the presence of an emergency vehicle, the sensors trigger the signal to turn green. This ensures that the emergency vehicles like ambulances or fire trucks are able to get a free passage through dense traffic intersections. There is one sensory device installed at every intersection and another embedded in the emergency vehicle. Now, these two devices interact with each other. The device at the intersection could detect an emergency vehicle approaching from 500 m up to 1 km. Once detected, the

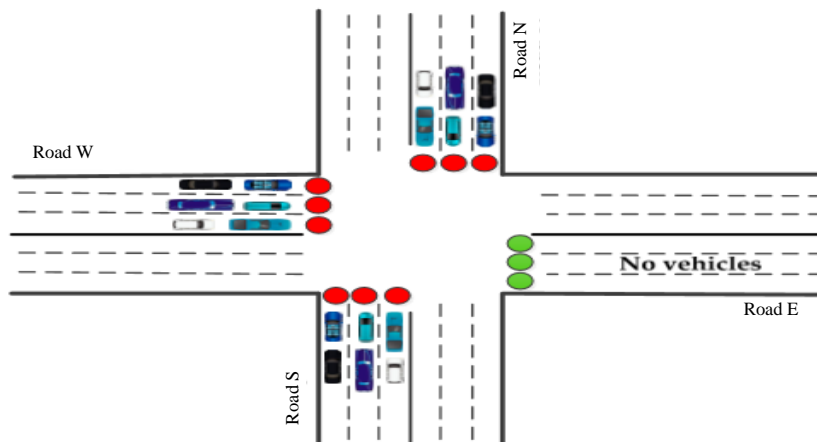

Fig. 2: Traffic at crossing

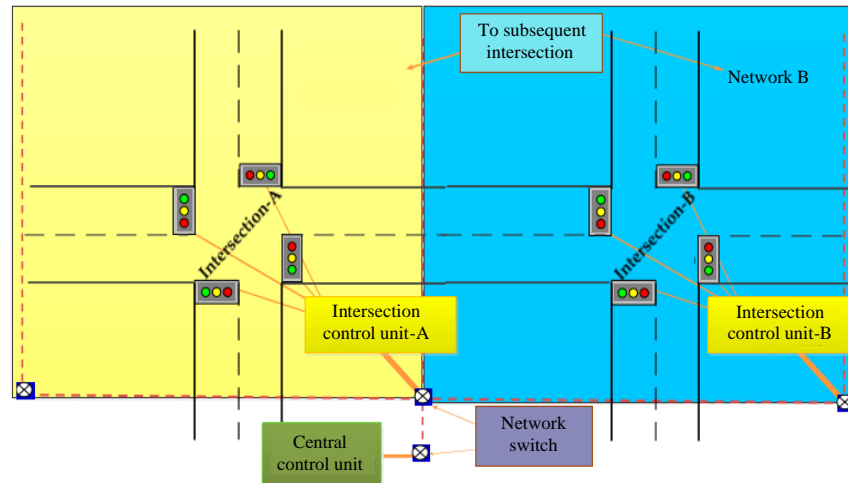

Fig. 3: Traffic controller at intersection

signal doesn't immediately turn green. Doing so would result in a chaotic situation. The algorithm is designed in such a way that it knows where the ambulance is heading, and the exact time of approach. Various parameters could be attributed to that: Speed, direction, latitude and longitude. The pre-emption can be initiated at a particular distance from the junction. This makes the technology completely user provisional it can either be run from a local traffic intersection, or remotely from a traffic control center. The block diagram of the proposed is give in Fig. 4.

My proposed work is very important in the context of the smooth movement of the emergency vehicles (ambulance, police cars, fire brigade). In the case of emergency, the smooth movement of the emergency vehicles is very critical and it should arrive on the time to the destination. By implementing this proposal successfully, we can make the smooth movement of the emergency vehicles and can save the lives of people and reduce the response time in case of emergency. It is very much needed to solve this problem in the scientific way instead of make new roads and it will cost too much. It is the best solution to make the cities smart and intelligent based on the scientific research way.

Implementation: The proposed method is implemented in NS2, simulations results show the efficiency of solving the traffic congestion using sensors. Based on the speed, sensors will communicate wirelessly with the traffic control system of the various junctions. The result clearly says that the highest priority is given to the emergency vehicles such as ambulance, fire brigade and police vehicles.

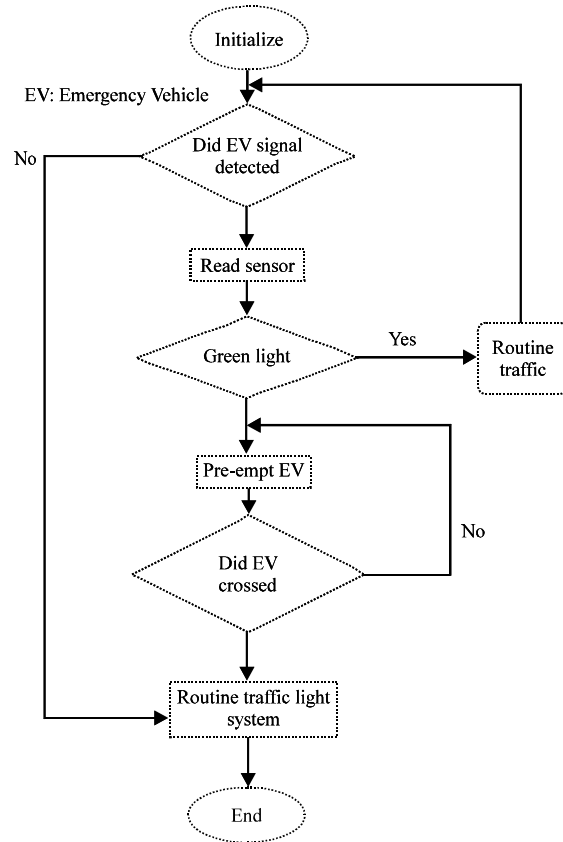

Fig. 4: Working of algorithm

Wireless sensor network (wireless node): The wireless nodes are already present in NS2 tool and for their actual implementation this section gives the wireless sensor network and its hardware that will detect the vehicles on the road.

Arduino mega: Arduino mega is used and the electronic board is made up of open source electronic circuit with a precise controller on one board to be programmed. Embedded programming is done with Arduino mega controller to change according to requirement (Fig. 5).

Vehicle detection sensor: In this project magnetometer sensor is used for vehicle detection. The sensor detects signals from coming emergency vehicle. Based on the signal received it is estimated how much time will vehicle take to reach at intersection and according to that the signal turned green until emergency vehicle crosses the intersection.

Communication protocol: I adopt oss monitor UDP protocol. The delay of acknowledgement packet causing data loss and delay convergence is removed and

overcome in this protocol. The data at the sensor nodes in the WSN is periodically updated and transferred to ICA.

Road intersection configuration: In this research work intersections controlled by the traffic lights corresponding to each road has been used. The traffic light is responsible for controlling traffic on its corresponding lanes. We assume the right lane turns right only, central lane goes straight or left and left lane goes left only. We deploy sensor nodes on every lane. We place the sensor nodes where they can monitor the traffic before entering the intersection and after leaving the intersection. We use the nodes placed after the intersection to locally determine the direction of the vehicle within one intersection.

MATERIALS AND METHODS

In the project “NS2” is used to simulate proposed algorithm before implementing as prototype and simulated results are very much satisfactory. The proposed algorithm automatically detect the emergency vehicle and provide clear way before the arrival at intersection. The algorithm also has the ability to manage traffic que by adding extra time to green light to clear way and extra time allocation is based on the length of que in particular side of the intersection. After simulation proposed algorithm was implemented as prototype as shown in the Fig. 6. In the Fig. 6, it shows the prototype of the signal system which is built and used to performance experiment. In

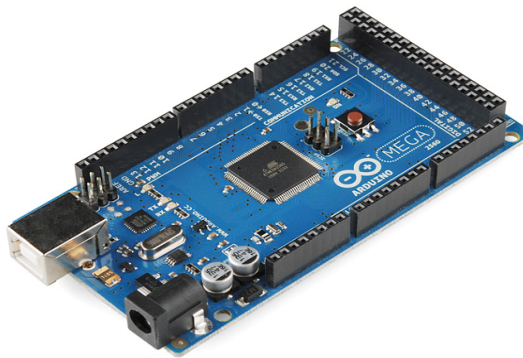

Fig. 5: Arduino mega controller

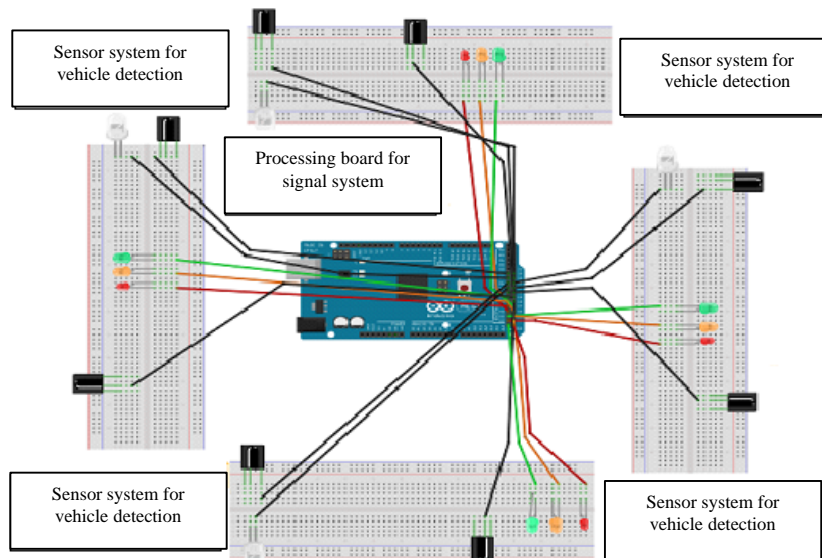

Fig. 6: Simulated prototype

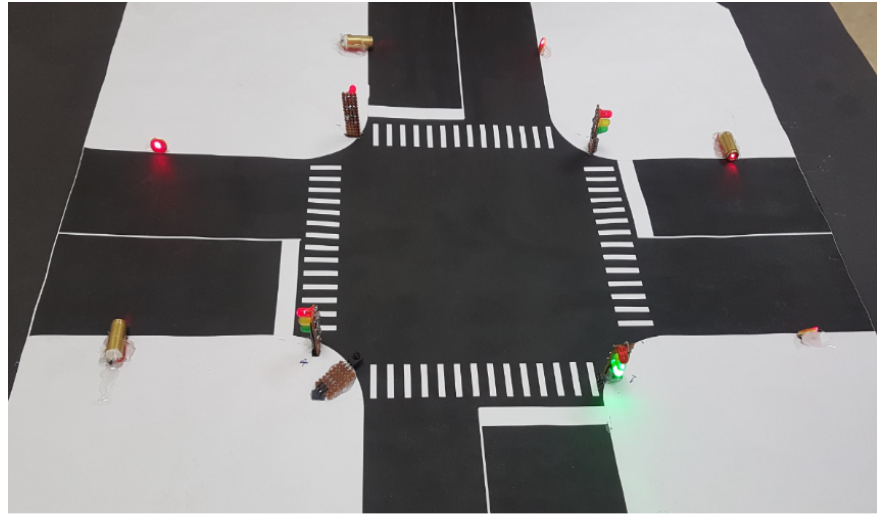

Fig. 7: Designed prototype

Figure 7 it shows the traffic signal system prototype which is used at junction (4 ways). The sensor system which is embedded with the signal system detect the signal from coming emergency vehicle from defined distance and turned on green at the defined distance of the emergency vehicle from the signal. The signal turned in normal execution after passing of the emergency vehicle.

Figure 7 shows that if there is long que of vehicles on one side of the road and based on the length of the que on that specific side, the signal goes green for extra defined time to clear the traffic from that particular side. The system which is installed and embedded with the signal system is completely autonomously running and can be monitored from remote office.

RESULTS AND DISCUSSION

In this study the performance of the algorithm is evaluated with the comparison of the normal signal system. The average end-to-end delays (sec) has been evaluated against the number of nodes at the particular signal. The proposed algorithm simulated by using simulation tool and based on the simulation results a complete prototype system is designed. The prototype system is tested against the traffic generated as shown in the previous section.

Figure 8 shows the average delay with and without algorithm, it shows that average delay is significantly lower with algorithm as compare to average delay of without algorithm (normal traffic). The average delay by implementing the algorithm is almost 50% < normal traffic. Implementation of the proposed system with the exiting

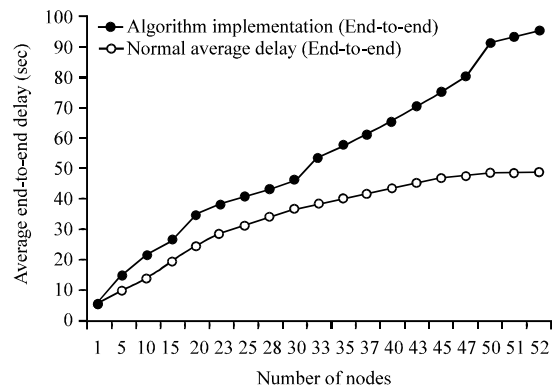

Fig. 8: Designed prototype

signal system is very easy and cheaper. By successfully implementing the proposed system will be very beneficial to the cost and time of the running vehicles specially emergency vehicles (Ambulance, fire fighter, police cars).

CONCLUSION

In this research work, the proposed algorithm for emergency vehicle has been simulated in Network Simulator (NS2). Wireless sensor based intelligent design has been presented to manage the road traffic and smooth flow of emergency vehicle. The proposed algorithm has the ability to provide clear way to the emergency vehicles along with reduce the congestion at cross sections. The proposed system can easily be integrated with existing traffic signal system by spending low money and within reasonable time to manage the smooth flow of

vehicles on the road. The proposed algorithm automatically detect emergency vehicles and length of the que for self-configuration and communicate with neighboring nodes. The prototype which is designed based on simulated algorithm is working very well to manage the traffic at cross section based on the traffic.

RECOMMENDATIONS

In future, the proposed algorithm can easily be enhance by using wireless sensor network for the smooth flow of the emergency vehicles from starting point to the destination. The emergency vehicle finds all signals green on the route up the destination.

REFERENCES

- Avzekar, M.K. and A. Moon, 2014. Adaptive traffic signal control with vanet. *Intl. J. Sci. Eng. Res.*, 2: 30-32.
- Goel, A., S. Ray and N. Chandra, 2012. Intelligent traffic light system to prioritized emergency purpose vehicles based on wireless sensor network. *Int. J. Comput. Appl.*, 40: 36-39.
- Hussian, R., S. Sharma, V. Sharma and S. Sharma, 2013. WSN applications: Automated intelligent traffic control system using sensors. *Intl. J. Soft Comput. Eng.*, 3: 77-81.
- Shruthi, K.R. and K. Vinodha, 2012. Priority based traffic lights controller using wireless sensor networks. *Intl. J. Electron. Signal Syst.*, 1: 58-61.
- Sinhmar, P., 2012. Intelligent traffic light and density control using IR sensors and microcontroller. *Intl. J. Adv. Technol. Eng. Res.*, 2: 30-35.
- Vidhya, K. and A.B. Banu, 2014. Density based traffic signal system. *Intl. J. Innov. Res. Sci. Eng. Technol.*, 3: 2218-2222.
- Viswanathan, V. and V. Santhanam, 2013. Intelligent traffic signal control using wireless sensor networks. *Proceeding of 2nd International Conference on Advances in Electrical and Electronics Engineering*, March 17-18, 2013, Planetary Scientific Research Center, Dubai, UAE., pp: 165-169.
- Yousef, K.M., M.N. Al-Karaki and A.M. Shatnawi, 2010. Intelligent traffic light flow control system using wireless sensors networks. *J. Inf. Sci. Eng.*, 26: 753-768.