

## A Novel Controlling Strategy for Mitigating the Impacts of Voltage Sag using Dynamic Voltage Restorer

<sup>1</sup>B. Durai Babu and <sup>2</sup>P. Murugesan

<sup>1</sup>Department of Electrical Engineering, Sathyabama University,  
Chennai, 600119 Tamil Nadu, India

<sup>2</sup>Department of Electrical and Electronics Engineering, S.A. Engineering College,  
Chennai, Tamil Nadu, India

---

**Abstract:** Mostly the power quality is affected due to the sensitive loads. These power quality issues create many disturbance like voltage sag, voltage swell, harmonic distortion and transient voltage. Due to the development of the power electronic technology, several mitigation techniques were emerged. From the wide range of mitigation technique we have taken a Dynamic Voltage Restorer (DVR) to protect from the sensitive loads. But it suffers with some of the drawbacks like, increased voltage limits, less capacity on compensating the line voltage and high transients. To overcome these drawbacks the DVR used in this research contains 3 ph six leg inverter and a LC filter to remove the unwanted frequencies. Moreover, a Space Vector Pulse Width Modulation (SVPWM) control strategy is used to manipulate the six leg power switched inverter, based on the space current and voltage converter switching. This research is intent for less expensive approach for this SRF theory helps to avoid the excessive controller in all three phases. Instead the d and q control strategy requires only two controller for all three phases. The performance analysis of the proposed system is evaluated by analyzing the power consumption and efficiency. Moreover the proposed system is compared with existing works related to this research work.

**Key words:** Index terms dynamic voltage restorer, power distribution system, voltage sag mitigation, space vector pulse width modulation, synchronous reference theory and dq0 transformation, DVR

---

### INTRODUCTION

Power quality issues are major thread in the field of electrical power distribution and transmission. Mostly the Power Quality (PQ) issues happen based on the nonlinear load or improper power distribution. Usually the PQ can be represented as the deviation of current, voltage and frequency from its standard values in a power system. Among that all the voltage swell/sag and harmonics are the severe disturbances. Most importantly two approaches are in practice to mitigate the PQ issues. Either this issues can be eliminated from the consumed end or else from the utility side. One of the approach namely, load conditioning this will guaranteed that all the components or equipment's are less sensitive over the power disturbances. Providing the operation under a considerable voltage distortion. The next solution, erect the line conditioning systems to suppress the disturbances in the power system lines. Due to the voltage deviation the electrical utility can't able to deliver a pure sine waveform. The voltage sag may occur at any time with the amplitude ranges from 10-90% under a duration of half a cycle. One of the most suitable technique to eliminate all the issues, an electronic converter were

developed based on the custom power devices. By considering many devices, the DVR is consider to be the efficient and economic device to safeguard sensitive load from voltage sag and swell. In addition, DVR will reduce the harmonics and helps to eliminate the transient voltage and fault current. This device will placed in between the sensitive load and the grid (Li *et al.*, 2010; Olivares *et al.*, 2014) it act as an interface solution in-between the distribution network and grid. Moreover, DVR can be used for disconnection of microgrids from the grid and used to reconnect further (Katiraei *et al.*, 2005) (Fig. 1).

In this proposed research, to eliminate the voltage disturbance and to improve the PQ in a power distribution, a DVR is added to the distribution line. The SVPWM control strategy which is used to manipulate the six leg power switched inverter, based on the space current and voltage converter switching. In addition, a new controlling scheme based on Synchronous Reference Theory (SRF) is proposed. In this research a three phase nonlinear load is consider as an input. In which the controller in all three phases is consider to be more expensive, to avoid the need of excessive controllers, d and q strategy is proposed to limit the controller usage. To

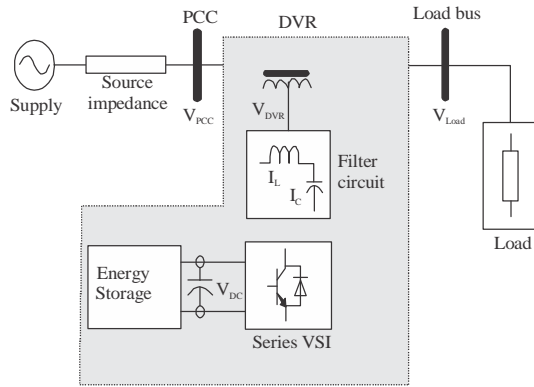

Fig. 1: Schematic diagram of DVR (Li *et al.*, 2007)

eliminate the harmonics a LC filter circuit is used. The SRF controller generates the switching pulses for the converter to reduce the voltage disturbances.

**Problem identification:** The electric power quality can be characterized into two main factor as continuity and quality as represented in the IEEE standard 1100. Among the PQ problems, the voltage sag, swell and harmonics creates a major issues (Pal and Gupta 2016). To overcome and improve the power quality the DVR is introduced to reduce the voltage fluctuations with improved efficiency (Wang, *et al.*, 2017). For designing the Voltage Source Inverter (VSI) there are some conditions need to (Far, *et al.*, 2017). Moreover some of the filters are utilized to reduce the harmonics in the circuits. In the existing works, many controlling algorithm was proposed to overcome the (Muluk, *et al.*, 2017). The limitations of the existing works are, Increased Transient voltage, disturbances due to harmonics, no capability on handling the active power flow etc.... This research is intent to develop a new control strategy to overcome all this problems. The main contribution of this proposed research is:

- To minimize the voltage sag/swell in the distribution system
- To propose a control strategy based on SRF is developed
- To eliminate the harmonic distortion with the help of improved LC filter technique
- To convert the three phase voltage current into the  $\alpha$ - $\beta$  reference, the DQ0 transformation technique is implemented

**Literature review:** This section reviewed some of the existing works related to our research work. Francis and Thomas (2014) describes about the merits of adding DVR in a distribution system to eliminate the power disturbances. A sinusoidal PWM based was developed to

find and to eliminate the PQ disturbances in distribution system. The dq0 transformation also called as Park's transformation was used in the DVR controller. This study concludes that the DVR will reduce the voltage sag effectively with a better voltage regulation (Galeshi and Iman-Eini, 2016) designed a DVR with a capacitor energy sources with a cascaded multilevel inverter. This inverter will enable the DVR to connect directly for eliminating the series injection transformer. To reduce the delay time of DVR, a fast 3ph estimation method was also used. The experiment was carried out on a 7 level cascaded H-bridge converter. They have employed a fast estimation method this will helps to recognize voltage sag in approximately half a cycle. Sundarabalan and Selvi (2015) proposed a DVR for fuel cell stack to the grid with respect to the optimal PI and fuzzy controller. In which both the controller were utilized to generate the ref voltage signal to control the voltage source converter with the help of PWM generated switching pulse. In the end, FL controller DVR has effectively minimize the total harmonics in the sensitive load by comparing with the existing PI controller. DVR. Torres *et al.* (2018) presented a control scheme namely, a two Degrees of Freedom (2DOF) in a DVR. In addition, double control loop schemes deliver the current controller. In this proposed research, under the nominal frequency condition the nested regulator got perfect zero tracking and blocks DC offset. Shahabadini and Iman-Eini (2016) have developed a interline DVR (IDVR) to mitigate the voltage sag, this was made of many DVRs. In that the DVR was connected with the distribution feeder in a series manner. During sag, the active power was moved from the feeder to another feeder and this will also mitigate the long durational voltage sag. De Almeida Carlos *et al.* (2016) proposed a control system based on PWM under three phase four wire. For better understanding the proposed work is consider with two different types of power distribution which includes 3P3W and 3P4W. This system develops based on the reduced harmonic distortion, low electromagnetic inference and high operating voltage capacity (Praveena and Jayashree, 2014) explains about the mitigation of voltage sag by introducing the DVR. A PI controller and discrete PWM pulse generator were used for the control scheme. Moreover, a feed forward technique was proposed. It has established the outcome of the DVR using PI controller in which this can operates well under a linear static load and induction motor load. (Natesan and Venkatesan 2016) presented a SRF theory based Phase Locked Loop (PLL) to improve the efficiency of DVR. This research presents a novel SRF-PLL which helps to estimate phase and frequency to obtain grid control. The SRF theory was the transformation of variable in synchronously rotating d-q frame. In this research, the proposed method was presented based on the SRF theory. Tashackori *et al.*

(2013) presented 3P4W DVR to provide a series voltage for compensation to the electric power system. In this DVR contains 3ph 4 leg inverter and 3ph high frequency harmonic filter this will be connected to the 3ph power transformer. This novel technique effectively generate the switching pulses for the power switches. The results shows that the DVR delivers a series voltage at the time of utility voltage disturbances and maintain the load voltage at a desired value. Vilathgamuwa *et al.* (2002) designed a new Phase Advance Compensation (PAC) to improve the property of voltage restoration. It is main based on the few factors, like compact system with reduced energy storage, minimizing the magnitude of the injected voltage and improved reactive power depends on advanced angle and sag. Usually the DVR characteristics was depend on the dynamic behaviour and accuracy of the voltage synthesis and control system. Lu *et al.* (2016) analyzed the control and operation of a 1ph 3 leg unified power quality conditioner and to solve the coupling problem naturally by a novel space vector model. This scheme reduces the switching loss or harmonic distortion. The models was based on the operation of TL-UPQC configuration. In which the implementation of the MM2 reduces the harmonics distortion of the drawn current. presented a new technique by incorporating the inverter with DVR for limiting the size of energy storage element. This method will compensate the long-time voltage sag issues by improving the structure of source side shunt rectifier. Mohan and Devi (2013) presented a design of DVR using a SPWM and SVPWM. In this the detection of sag and swell was carried out by dq0 theory. The simulation results shows that the SPWM needs 15% more dc voltage than SVPWM for the equal value of output (Madhavi *et al.*, 2016) developed a design to enhance PQ by DVR using SVPWM technique. This research states that the proposed SVPWM generate the pulse for mitigating the voltage sag. This method was dragged with a long duration voltage sag. Qi *et al.* (2014) presented an PWM rectifier based active power decoupling method to get the sinusoidal input current at the AC end and a ripple power decoupling at the DC end without the need of any additional switches. In this method, an auxiliary decoupling capacitor was used for the PWM to limit the use of capacitance. Because of the inadequate usage of the controller switches, the rectifier will reduce the input power and reduces the flux variation for output current ripple. The rectifier resulted in low power density by the use of bulk capacitor bank for filter. Jowder (2009) developed a voltage sag and harmonics detection mechanism for designing the DAR. This proposed work is based on the hysteresis voltage control in that by compressing the voltage the power quality can be increased. A step up DC motor can control the dc voltage of the inverter. A PI controller based control strategy was derived. Over all this research shows that the time domain

simulation performed to prove the performance of voltage sag compensation method. Babaei and Kangarlu (2015) reviewed different topologies for three phase DVR to enhance the power quality. In this design, the inverter of each phase was independently operated and controlled for balancing the voltage sags and swells. In this, the H bridge inverters requires only less amount of the switching devices from the DVR. Three different compensation strategies were analysed.

After, analysed all the existing works we have noticed many drawbacks, some of the limitations are stated below as:

- Long duration voltage drag
- High compensation time
- Less capability on handling the voltage distribution
- Maximum injection capability

To eliminate all these draws we have proposed a new controlling strategy based in the DVR with improved efficiency.

## **MATERIALS AND METHODS**

This section deal the detailed description of the proposed work with a clear flow representation. The motive of this work is to minimize the voltage sag and swell. For that a new controller technique based on SRF is introduced. In this proposed work the DVR will be connected with the nonlinear load. The Dc quantities are estimated with the help of dvo transformation technique and the LC filtering technique is used to filter the quantities. After that, the SVPWM generates the pulses for voltage source inverter which is given to the non-linear load connected with the grid. Finally, the voltage sag mitigation of DVR is analysed by evaluating the power consumption and efficiency measures. Figure 2 illustrate the flow chart of the proposed work.

From the flow chart, the source reference signal and the load reference signal is given as input to the Clarke transformation. In the ABC to  $\alpha$  and  $\beta$  and the analog filter design is analysed in the hysteresis controller. To support this hysteresis controller and a PID controller is used. The converter source and the constant value is given as an input to the PID controller. Then controller signal will be given to the voltage source inverter, based on that the 3 ph RLC branch is connected with the nonlinear load or the grid. In the controller design, the SVPWM based on 3ph inverter will process the input voltage. The novelty of the proposed work is based on the SRF and Abc to dq0 transformation techniques. Here, the clarke transformation technique namely dq0 transformation is used, this helps to control the DVR by analyzing the sag depth, this technique is based on the direct space vectors.

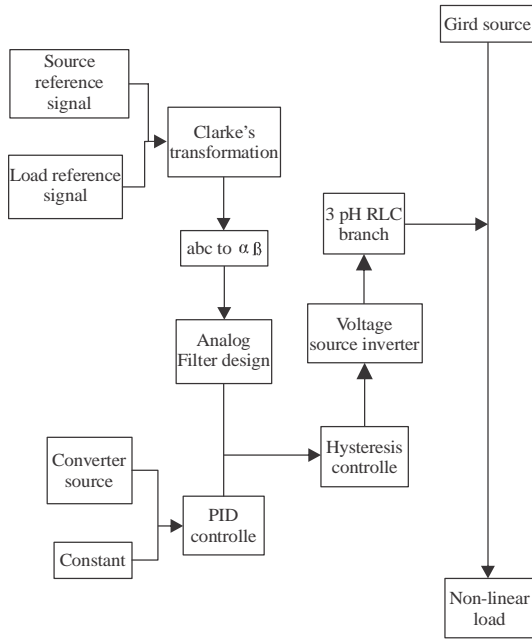

Fig. 2: Overall flow diagram of the proposed work

The orthogonal  $\beta$  phase was processed by the quarter cycle time delay method. The formation of  $\alpha$ - $\beta$  quadrature phases look like the Clarke's transformation in 3ph theory. At the same time the  $\alpha$  and  $\beta$  instantaneous values are converted into SRF based d-q components. In this process the voltage reference and terminal voltage are compared for identifying the voltage sag. At this point, if the voltage is  $<90\%$  of the reference value they it seems to be the voltage sag or else if the voltage value is increased by 25% then it is said to be voltage swell. The process of converting stationary frame shows the space vector transformation of 3ph time domain signals. This new controlling technique will minimize the total harmonics by limiting the inductance voltage.

**Modelling of synchronous reference frame theory controller:** The concept of the SRF theory is represented bu the frame which rotates at a synchronous speed under a three phase quantity of voltage and current rotates in space with the speed. Ina three phase line, placing an individual controller for each phase will increase the cost of the system. So, the SRF theory is used to reduce the quantity of the controller in which instead of placing three controller two controller is placed by the help of d and q control strategy (Fig. 3).

The operation is represented as in the two axis namely (d and q) axis, the q-axis leads the d-axis by  $90^\circ$ , so, this becomes our reference frame (dq) axis, we consider that the reference frame theory is rotating synchronously same as that of the system frequency, the phasor is rotating at the speed 'W' and the reference

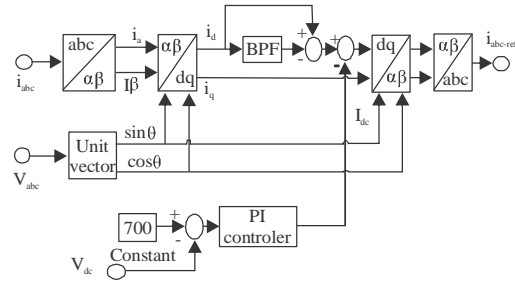

Fig. 3: Clarke transformation based power filter

frame rotates at the same speed 'W'. Therefore, the relative speed between the rotating phasor and the reference frame is zero. Then we observed the DC quantity and then it can be resolved along the d and q axis, so, the advantages of this controller is that we are dealing with the DC quantities and for the control applications it is very easier to control without having any steady state errors. The transformation from  $\alpha$  and  $\beta$  to d-q frame, the transformation matrix is given below:

$$\begin{pmatrix} d \\ q \end{pmatrix} = \begin{pmatrix} \sin\theta & -\cos\theta \\ \cos\theta & \sin\theta \end{pmatrix} \begin{pmatrix} \alpha \\ \beta \end{pmatrix} \quad (1)$$

The inverse of this transformation:

$$\begin{pmatrix} \alpha \\ \beta \end{pmatrix} = \begin{pmatrix} \sin\theta & -\cos\theta \\ \cos\theta & \sin\theta \end{pmatrix} \begin{pmatrix} d \\ q \end{pmatrix} \quad (2)$$

This equation is used to obtain the values corresponding to the reference frame moving at the certain frequencies, the linear controller is implemented using the proportional and integrative controller, the controller has inner and outer loop to control the current and voltage, respectively, the sensed coefficients uses the PI controller to reduce the non-linearity and local d-q couplings. The d and q axis voltage controller are derived using the PI controller, the DC signals are used as reference to control the AC values and simple linear controller can be used to restrict the sensed values to be within the limits nearer to the reference values. The cross coupling of the terms between the dq components results in cancelling of active and reactive components along with the non-linearity.

**Filtering:** In the transmission and distribution system the long term voltage sag will leads to the fault in the transmission line. The main purpose of the filtering scheme is to minimize the harmonics voltage distortion at the load side. In this research a LC filter is proposed which to filter out the oscillatory components and harmonics of the voltage. This filtering technique

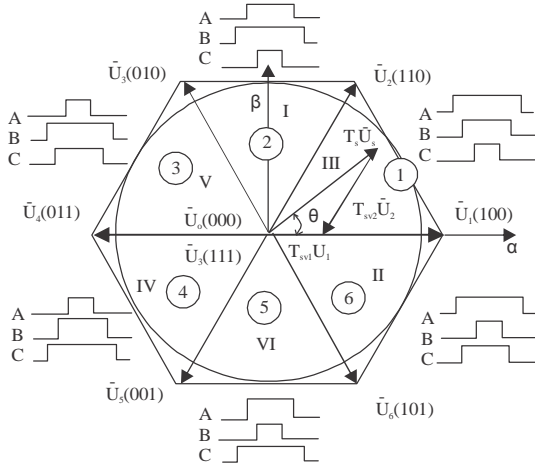

Fig. 4: Voltage vectors, vector summation method and PWM waveform

maintains the harmonic content at the permissible level. In which the input is verified by the LC filter to filter the unwanted frequencies afterwards the output I injected through a series injection transformer to maintain the load voltage magnitude. The capacitor value of the filter is estimated based on the resonant frequency.

**SVPWM controller of dynamic voltage restorer:** The SVPWM control strategy which is used to manipulate the six leg power switched inverter, based on the space current and voltage converter switching. The 3ph system shows the vector rotating under the synchronous speed based on the stationary orthogonal  $\alpha$ - $\beta$  axes where the  $\alpha$ -axis coincides the  $V_\alpha$  axis, constant vector magnitude and it is equal to the sum of 3ph voltage under any condition (Fig. 4). This vector can be demonstrated on the  $\alpha$ - $\beta$  to give  $V_\alpha$  and  $V_\beta$ . For a converter under the DC source, contains only eight possible switching states with eight vectors ( $V_0$ - $V_7$ ). These vectors splits the space into the six sectors if the reference voltages are:

$$V_a = V_m * \cos * \omega t \tag{3}$$

$$V_b = V_m * \cos * (\omega t - 120) \tag{4}$$

$$V_c = V_m * \cos * (\omega t + 120) \tag{5}$$

Then the reference vector will be:

$$\vec{V}_{ref} = \sqrt{\frac{3}{2}} V_m e^{j\theta} \tag{6}$$

where,  $\theta = \omega t$ . The ref vector is contains to adjacent vectors like  $V_N$  and  $V_{N+1}$  alongside with two null vectors

Table 1: Binary states representation of SVPWM

State (abc)	Vector	Magnitude	Angle
000	$V_0$	0	0
100	$V_1$	$\sqrt{2/3} * V_{dc}$	0
110	$V_2$		60
010	$V_3$		120
011	$V_4$		180
001	$V_5$		240
101	$V_6$		300
111	$V_7$	0	0

$V_0$  and  $V_7$  with considering that the switching loss can be limited. To find the time duration, a concept of equal volt-second area is used:

$$\vec{V}_{ref} * T_s = \vec{V}_N * T_N + \vec{V}_{N+1} * T_{N+1} \tag{7}$$

Therefore, by using the time of every firing state can be analysed to represent the firing angles (Table 1).

**Mathematical modelling:** The load bus fault level causes the impedance of the system, during the time of grid voltage issues like voltage sag/swell when the load needs the additional power from the dynamic voltage restorer, the series injection transformer injects the required voltage by the critical load for that the line parameters like current and voltage at load side and the reference parameters are taken into account and the three phases are converted into two phases for the convenience of the controller to apply, so, based on the comparison of the values the space vectored pulse width modulation signals are generated for the VSI of the dynamic voltage restorer and the injected input is verified by the LC filter to filter out the unwanted frequencies after that the output is injected through the series injection transformer to maintain the load voltage magnitude, if the voltage drop in the grid occur then the DVR inject voltage this can be calculated as:

$$V_{dvr} + V_{def} = V_{im} + Z_s I \tag{8}$$

$$V_{dvr} = V_{im} + Z_s I - V_{def} \tag{9}$$

Where:

$V_{im}$  : Desired load voltage magnitude

$Z_s$  : System impedance

$I$  : Load current

$V_{def}$  : System voltage at fault condition

The load current can be written as:

$$I = \left( P_1 + \frac{Q_1}{V_1} \right) \tag{10}$$

$$V_{dvr} \text{ angle of } \alpha = V_i \text{ angle of } 0 + Z_s I_1 \text{ angle } (\beta - \theta) - V_s \text{ angle of } \delta \quad (11)$$

where, the angle of  $\alpha$ ,  $\beta$  and  $\delta$  are the angle of  $V_{dvr}$ ,  $Z_s$ ,  $V_s$ , respectively and the  $\theta$  is the load power factor angle with,

$$\theta = \tan^{-1} \left( \frac{Q_l}{P_l} \right) \quad (12)$$

Dynamic voltage restorer injected power can be written as:

$$S_{dvr} = V_{dvr} * I_1 \quad (13)$$

### RESULTS AND DISCUSSION

**Performance analysis:** This section validates the proposed control strategy. The performance is examined by different parameters like phase current, phase voltage, filtering output and the triggered pulses. The simulation details of the proposed work is illustrated in Table 2.

**Three phase output voltage at grid side:** The phase angle and frequency of the sinusoidal waveform is described with the help of sinusoidal voltage and current measurement. Figure 5a, b illustrate the three phase output voltage and output current in the grid. In which the blue line represent phase A, red line represents phase B and yellow line represents phase c.

**Filter outputs:** During the conversion process some unwanted frequency will be produced in the output load. To eliminate these noises, LC filter is used. Figure 6 and 7 illustrate the output voltage obtained from the filter. This graph shows the output for all three phase Fig. 8.

**Load side three phase output voltage:** Figure 7a, b represents the three phase voltage and current sinusoidal waveform at the load side. After the pulse generation, the inverter load will be delivered to the nonlinear load side. This graph illustrate that the proposed work performance well by compensating load and eliminates the voltage disturbances. By considering the depth of the voltage sag, the amplitude of the output voltage need to be maintain constant for all phases.

Table 2: Simulation specifications

Parameters	Values
Input voltage	700 V
Output voltage	300 V
Inductor	L1 = 75 mH, L2 = 75 mH
Capacitor	C1 = 750 $\mu$ f , C2 = 750 $\mu$ f
Load resistance	60 $\mu$
Load inductance	0.15 mH
Nominal power	4000 VA
Nominal frequency	60 Hz

**Pulse operation of IGBT switches:** The motive is to generate a triggering pulse to the voltage source inverter. In that the operation is based on the six IGBT switches. Figure 6a, illustrate the direct and inverse pulse. In which the direct pulse represents the first three operation of IGBT switches and the Inverse pulse represents the next three operation of the IGBT switches.

**Comparative analysis:** Table 3 illustrate the comparative analysis between the proposed SRF theory controller with

Table 3: Comparative analysis of existing and proposed controller designs

Parameters	Open loop controller	Alpha-beta transformation
Phase Voltage (V)	100	13
Phase current (A)	18	150
VA per phase	1800	2080
KVA (% of load)	43.25%	45%
Supply current (A)	22.15	18
Load Voltage (V)	380.8	170

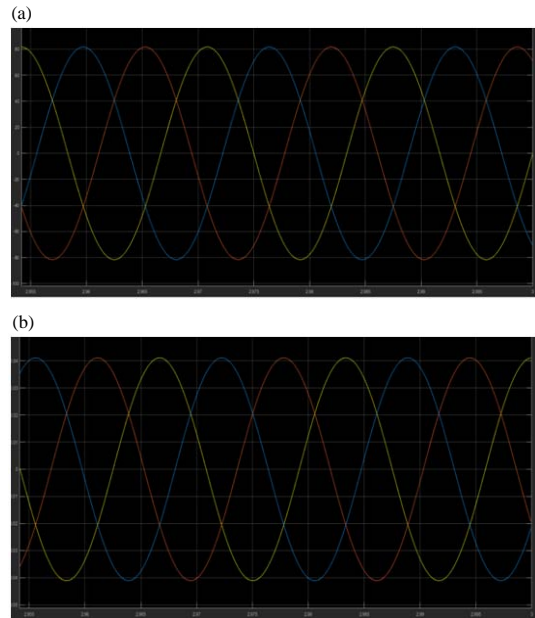

Fig. 5(a, b): (a) 3 pH sinusoidal voltage waveform at grid side and (b) 3 pH sinusoidal current waveform at grid side

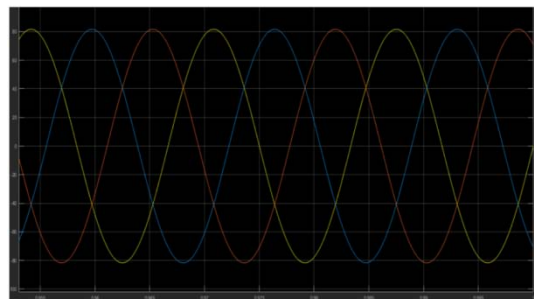

Fig. 6: 3 pH output waveform after filtering



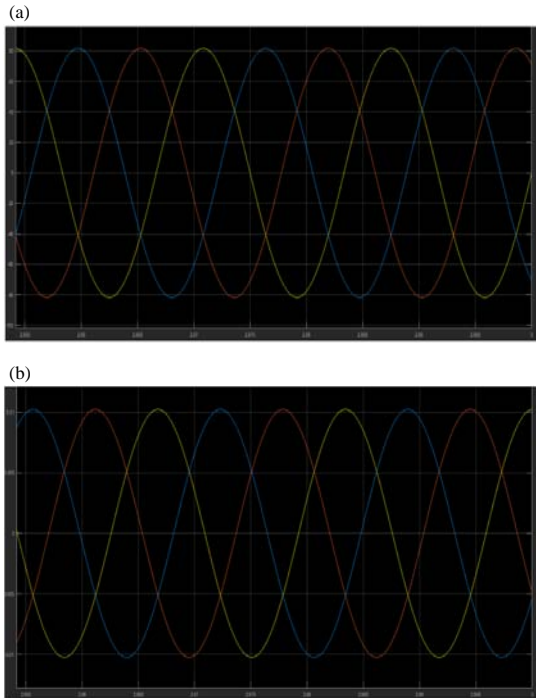

Fig. 7(a, b): (a) 3 pH sinusoidal voltage waveform at load side and (b) 3 pH sinusoidal current waveform at load side

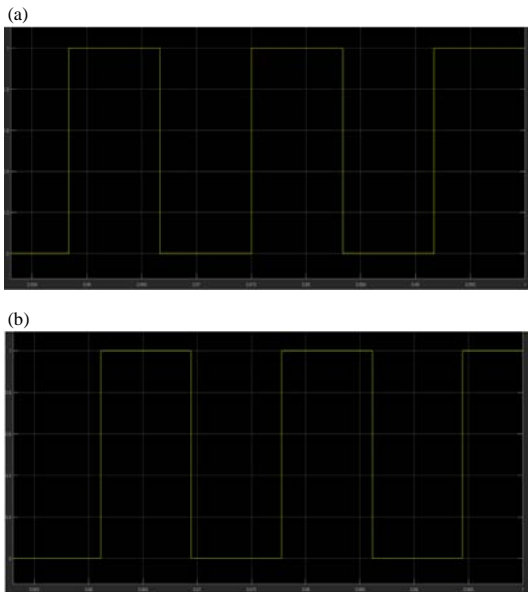

Fig. 8(a, b): (a) Output waveform of direct pulse and (b) Output waveform of inverse pulse

Clarke transformation and existing open loop controller. The analysis includes, phase voltage and current, power per phase, the percentage of load and load voltage. The measure of the proposed work is illustrated based on the

load side and grid side. The results shows that the proposed controller design delivers better results as compared with the existing controller.

**CONCLUSION**

The motive of this research work is to mitigate the voltage disturbances in the power distribution system. To achieve this, a new control strategy based on SRF theory is introduced with the SVPWM controller and the Clarke transformation. By combining all this new works with the DVR helps to compensate the voltage disturbances in the power distribution system. Initially, the 3ph nonlinear load is converted into d-q0 transformation. To eliminate the harmonics from the load a LC filter is utilized. Moreover, the SVPWM is utilized to generate the triggered pulses from the inverter and the load current is given to the nonlinear load. Finally, the power consumption and the energy efficiency of the proposed controller strategy is validated under different performance measures. During simulation, the phase current, phase voltage, supply current and load voltage are estimated. Then, the results of the proposed controller is analysed with the existing open loop controller. The results shows that the proposed controller technique performs well than the other existing works by efficiently mitigating the power quality issues.

**Future work:** In future, this reseach can be enhanced by implementing this controller scheme in the power system to attain the better synchronization and control over the grid, under symmetrical and asymmetrical fault condition.

**REFERENCES**

Babaei, E. and M.F. Kangarlu, 2015. Comparison four topologies for three-phase dynamic voltage restorer. Proceedings of the International Conference on Renewable Energy Research and Applications (ICRERA), November 22-25, 2015, IEEE, Palermo, Italy, ISBN:978-1-4799-9982-8, pp: 1527-1532.

De Almeida Carlos, G.A., C.B. Jacobina and E.C. Dos Santos, 2016. Investigation on dynamic voltage restorers with two dc links and series converters for three-phase four-wire systems. IEEE. Trans. Ind. Appl., 52: 1608-1620.

Far, M.M., E. Pashajavid and A. Ghosh, 2017. Power capacity management of dynamic voltage restorers used for voltage sag and unbalance compensation. Proceedings of the 2017 International Conference on Australasian Universities Power Engineering (AUPEC), November 19-22, 2017, IEEE, Melbourne, Australia, ISBN:978-1-5386-2648-1, pp: 1-6.

- Francis, D. and T. Thomas, 2014. Mitigation of voltage sag and swell using dynamic voltage restorer. Proceedings of the Annual International Conference on Emerging Research Areas: Magnetics, Machines and Drives (AICERA/iCMMD), July 24-26, 2014, IEEE, Kottayam, India, ISBN:978-1-4799-5202-1, pp: 1-6.
- Galeshi, S. and H. Iman-Eini, 2016. Dynamic voltage restorer employing multilevel cascaded H-bridge inverter. *IET. Power Electron.*, 9: 2196-2204.
- Jowder, F.A.L., 2009. Design and analysis of dynamic voltage restorer for deep voltage sag and harmonic compensation. *IET. Gener. Transm. Distrib.*, 3: 547-560.
- Katiraei, F., M.R. Iravani and P.W. Lehn, 2005. Micro-grid autonomous operation during and subsequent to islanding process. *IEEE. Trans. Power Delivery*, 20: 248-257.
- Li, F., W. Qiao, H. Sun, H. Wan and J. Wang et al., 2010. Smart transmission grid: Vision and framework. *IEEE Trans. Smart Grid*, 1: 168-177.
- Li, Y.W., P.C. Loh, F. Blaabjerg and D.M. Vilathgamuwa, 2007. Investigation and improvement of transient response of DVR at medium voltage level. *IEEE. Trans. Ind. Appl.*, 43: 1309-1319.
- Lu, Y., G. Xiao, X. Wang, F. Blaabjerg and D. Lu, 2016. Control strategy for single-phase transformerless three-leg unified power quality conditioner based on space vector modulation. *IEEE. Trans. Power Electron.*, 31: 2840-2849.
- Madhavi, R.H., A.M. Mulla and N.R. Thakre, 2016. Power quality improvement by mitigation of voltage sag with DVR using SVPWM technique. *Intl. J. Innovations Eng. Res. Technol.*, 3: 21-27.
- Mohan, G. and A.L. Devi, 2013. Design and simulation of Dynamic Voltage Restorer (DVR) using SPWM and SVPWM techniques for voltage sags and voltage swells mitigation. *Intl. J. Mod. Eng. Res.*, 3: 3469-3475.
- Muluk, N., A. Warsito and I. Setiawan, 2017. Voltage sag mitigation due to short circuit current using dynamic voltage restorer based on hysteresis controller. Proceedings of the 2017 4th International Conference on Information Technology, Computer and Electrical Engineering (ICITACEE), October 18-19, 2017, IEEE, Semarang, Indonesia, ISBN:978-1-5386-3948-1, pp: 108-112.
- Natesan, S. and J. Venkatesan, 2016. A SRF-PLL control scheme for DVR to achieve grid synchronization and PQ issues mitigation in PV fed grid connected system. *Circuits Syst.*, 7: 2996-3015.
- Olivares, D.E., A. Mehrizi-Sani, A.H. Etemadi, C.A. Canizares and R. Iravani et al., 2014. Trends in microgrid control. *IEEE. Trans. Smart Grid*, 5: 1905-1919.
- Pal, R. and S. Gupta, 2016. Simulation of Dynamic Voltage Restorer (DVR) to mitigate voltage sag during three-phase fault. Proceedings of the 2016 International Conference on Electrical Power and Energy Systems (ICEPES), December 14-16, 2016, IEEE, Bhopal, India, ISBN:978-1-5090-2477-3, pp: 105-110.
- Praveena, A. and M. Jayashree, 2014. Mitigation of voltage SAG using dynamic voltage restorer. *Intl. J. Eng. Adv. Technol.*, 3: 313-318.
- Qi, W., H. Wang, X. Tan, G. Wang and K.D. Ngo, 2014. A novel active power decoupling single-phase PWM rectifier topology. Proceedings of the International Conference and Exposition on Applied Power Electronics (APEC), March 16-20, 2014, IEEE, Fort Worth, Texas, ISBN:978-1-4799-2325-0, pp: 89-95.
- Shahabadini, M. and H. Iman-Eini, 2016. Improving the performance of a cascaded H-bridge-based interline dynamic voltage restorer. *IEEE. Trans. Power Delivery*, 31: 1160-1167.
- Sundarabalan, C.K. and K. Selvi, 2015. Compensation of voltage disturbances using PEMFC supported dynamic voltage restorer. *Intl. J. Electr. Power Energy Syst.*, 71: 77-92.
- Tashackori, A., S.H. Hosseini, M. Sabahi and T. Nouri, 2013. A three-phase four-leg DVR using three dimensional space vector modulation. Proceedings of the 2013 21st Iranian Conference on Electrical Engineering (ICEE), May 14-16, 2013, IEEE, Mashhad, Iran, ISBN:978-1-4673-5634-3, pp: 1-5.
- Torres, A.P., P. Roncero-Sanchez and V.F. Batlle, 2018. A two degrees of freedom resonant control scheme for voltage-sag compensation in dynamic voltage restorers. *IEEE. Trans. Power Electron.*, 33: 4852-4867.
- Vilathgamuwa, D.M., A.A.D.R. Perera and S.S. Choi, 2002. Voltage sag compensation with energy optimized dynamic voltage restorer. *IEEE. Power Eng. Rev.*, 22: 63-63.
- Wang, B., J. Ye, U. Manandhar, A. Ukil and H.B. Gooi, 2017. A DC microgrid integrated dynamic voltage restorer with model predictive control. Proceedings of the 2017 Asian Conference on Energy, Power and Transportation Electrification (ACEPT), October 24-26, 2017, IEEE, Singapore, ISBN:978-1-5386-0972-9, pp: 1-5.