

## Geology and Tectonic Evolution of the Pan-African Tulu Dimtu Belt, Western Ethiopia

Tadesse Alemu and Tsegaye Abebe

Geological Survey of Ethiopia, P.O. Box 2302, Addis Ababa, Ethiopia

**Abstract:** The Tulu Dimtu Belt (TDB) is a NNE-SSW trending litho-tectonic unit, which forms the southwestern and wider branch of the predominantly low-grade volcano-sedimentary terrane of the Pan-African Arabian-Nubian Shield (ANS) and occupies a key position in understanding the geodynamic evolution of the East African Orogen (EAO). The belt can be traced for the entire length of the Precambrian basement of western Ethiopian and appears to continue to the proposed Barka ophiolitic suture in Eritrea and the Sudan. It is characterized by a variety of lithological units, including gneisses, metamorphosed volcanic, volcanoclastic and sedimentary successions with associated mafic-ultramafic rocks of probable ophiolitic origin and granitoid intrusives. The rocks in the belt are divided into five informal litho-tectonostratigraphic units separated from each other by tectonic discontinuities. From east to west these are: High-grade (amphibolite facies) gneiss and migmatites, Sayi Chenga Group, comprising metavolcanics, mainly basic and associated metasediments, Tulu Dimtu Complex, composed of mafic and ultramafic rocks and associated volcano-sedimentary rocks of probable ophiolitic association, 2 Chochi Domain, characterized by medium to high-grade supracrustal gneiss and schist and Katta Domain, characterized by low-grade metavolcano-sedimentary and associated intrusive rocks. The TDB represents a zone of shortening and is one of the best examples of a polydeformed northwest-verging fold-and-thrust belt in the ANS. Early Deformation ( $D_1$ ) is a progressive shortening, which resulted in the development of northwest-verging thrusts and associated recumbent, tight to isoclinal folds with subhorizontal axes and shallowly SE-dipping and NNE-SSW trending axial planar foliations ( $S_1$ ). The asymmetry of  $D_1$  structures indicates an oblique (top to the northwest) sense of movement. This phase of deformation might be related to the closure of the oceanic basin which resulted in the northwestward obduction of the Tulu Dimtu ophiolites.  $D_2$  deformation resulted in steepening of  $D_1$  structures into upright folds.  $D_3$  deformation represents extensive shortening, which culminated in the formation of major NW-trending sinistral strike-slip faults/shear zones and minor N and NNE-trending sinistral/dextral strike-slip faults/shear zones that are superimposed at high angle to the  $D_1$  and  $D_2$  structures. The relationships between  $D_1$ ,  $D_2$  and  $D_3$  is consistent with development of the TDB during a period of oblique collision in response to a NW-SE compressional stress that induced sinistral transpression.

**Key words:** Arabian-nubian shield, east african orogen, oblique collision, pan-african, sinistral transpression, tulu dimtu belt, western Ethiopia

### INTRODUCTION

The Tulu Dimtu Belt (TDB) is a NNE-SSW trending litho-tectonic unit that forms the southwestern and wider branch of the predominantly low-grade volcano-sedimentary terranes of the Arabian-Nubian Shield (ANS) (Fig. 1) and occupies a key position in understanding the geodynamic evolution of the East African Orogen (EAO). EAO represents a plate tectonic cycle spanning a time-period of 350 Ma, beginning by about 900 Ma with rifting and continental break-up and ending by about 550 Ma subsequent to a continent-to-continent convergence between East and West Gondwana (Stern, 1993, 1994).

Several studies in the ANS have shown the presence of ophiolite belts and have attempted to integrate them to the evolution of the shield (Gass, 1977; Vail, 1983, 1985; Camp, 1984; Stoesser and Camp, 1985; Kröner, 1985). Based on the continuity of these ophiolitic belts and the variation in structural trend and style and contrast in geology across the belt (Bakor *et al.*, 1976; Camp, 1984; Shackleton, 1979; Duyvermann, 1984; de Wit and Chewaka, 1981; Vail, 1985; Berhe, 1990; Stern, 1994; Abdesalam and Stern, 1996) attempted to link the ophiolite belts to possible suture zones representing successive collisions of juvenile island arcs, Andean-type arcs or continental terranes (Fig. 1). Regional correlation of the Tulu Dimtu ophiolites with the Barka ophiolites in

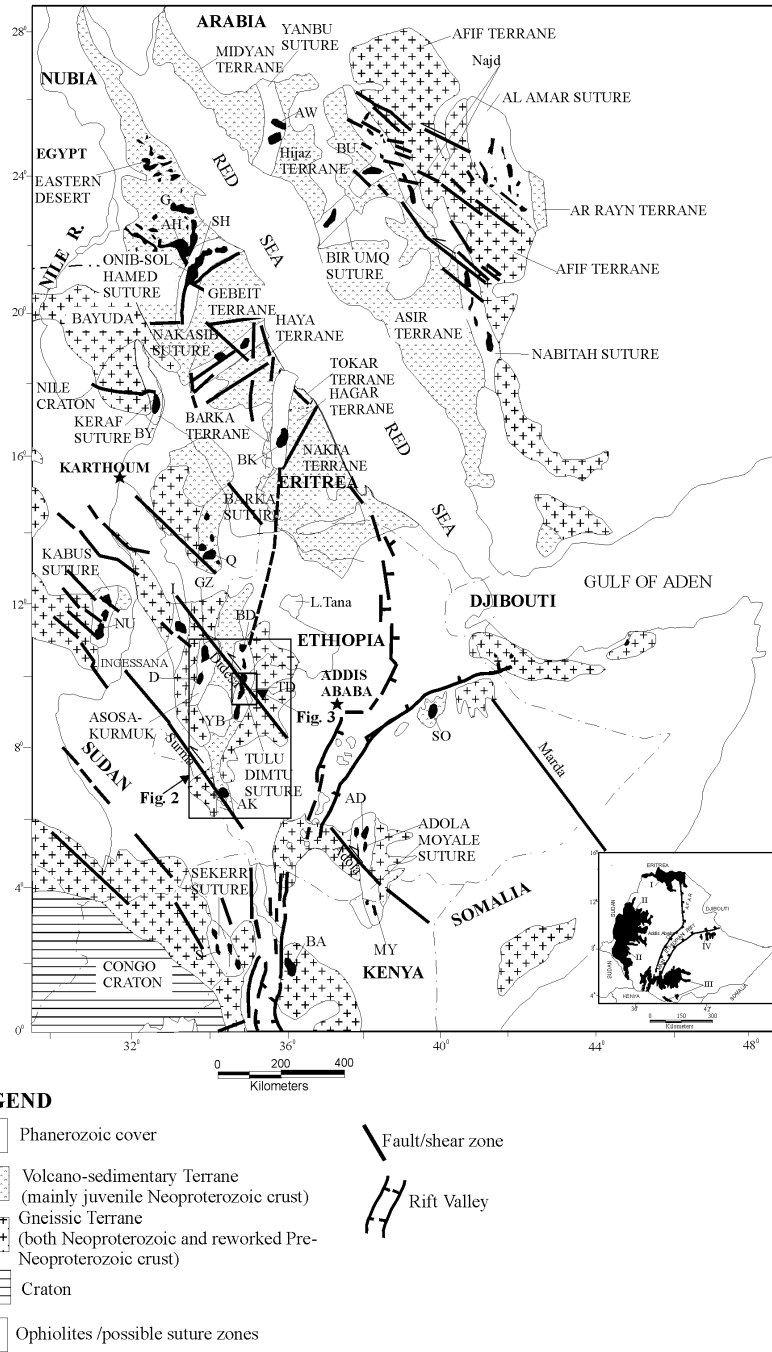

Fig. 1: Tectonic map of the Arabian-Nubian Shield showing its sub terranes and possible suture zones (modified after Vail, 1985). Ophiolites: AD, Adola; AK, Akobo; AH, Allaqi-Heini; AW, Jebel al Wask; BA, Baragoi; BD, Baruda; BK, Barka; BU, Bir Umq; BY, Bayuda; D, Dul, G, Gebel Gerf; GZ, Gizen; I, Ingessana; MY, Moyale; NU, Nuba; Q, Qala al Nahal; S, Sekerr; SH, Sol Hamed; SO, Soka; TD, Tulu Dimtu; YB, Yubdo. Heavy broken line to show the strike continuation of Barka-Tulu Dimtu suture zone. Inset showing the distribution of Precambrian rocks of Ethiopia: I) Northern Ethiopia Block, II) Western Ethiopia Block, III) Southern Ethiopia Block and IV) Eastern Ethiopia Block

Eritrea and northeastern Sudan has been suggested, identifying a structure referred to as the Barka-Tulu Dimtu arc-arc suture that separates terranes of presumably different ages (Fig. 1) (Abdelsalam and Stern, 1996).

The TDB in western Ethiopia separates high-grade gneiss and migmatites in the east from low-grade metavolcano-sedimentary sequences to the west (Fig. 1 and 2). The belt comprises metavolcano-sedimentary rocks and linear but, discontinuous bodies of 4 mafic and ultramafic rocks that crop out in several places along the belt, particularly at Yubdo, Daletti, Tulu Dimtu, Meti, Sirbanti and Baruda. The belt varies in width along strike, being wider in the north and narrower in the south. Further south, the belt pinches out and cannot be traced south of Yubdo. However, small outcrops of a similar association of rocks in the Akobo area (Akobo Domain of Davidson, 1983) are considered to be a southern continuation of this belt (Fig. 2) (de Wit, 1977; de Wit and Aguma, 1977). The Yubdo (UNDP, 1972), Tulu Dimtu (de Wit and Berg, 1978) and Daletti (Kazmin, 1969) bodies were investigated to assess their economic potential, but investigations at the other bodies were of lesser intensity. The Yubdo body, well known for its associated eluvial platinum deposits was investigated in most detail. The ultramafic occurrences in this belt were initially thought to be intrusives into the metavolcano-sedimentary rocks (UNDP, 1972), but were subsequently interpreted by Kazmin (1976, 1978) and de Wit and Aguma (1977) to be part of an ophiolitic sequence and are now referred to as the Sekerr-Yubdo-Tulu Dimtu-Barka suture zone (Berhe, 1990) or Barka-Tulu Dimtu suture (Fig. 1) (Abdelsalam and Stern, 1996). However, recently, Braathen *et al.* (2001) argued against the suggestion of the TDB as a possible suture zones, since rock units on either side of the belt are genetically related rather than being exotic as implied in suture zones. They suggested an arc and back-arc setting that experienced continental collision and tectonic shortening to account for the evolution of the belt.

Establishing local field, lithologic and structural details in areas identified as suture zones and understanding the kinematic relationships is important for any meaningful regional synthesis. This study presents the details of lithology and structure of the TDB between 9°00'N and 10° 00'N latitude (Fig. 2 and 3) and discusses the possible tectonic implications of the data to the evolution of the belt. Additionally, we discuss the implications of the belt for Neoproterozoic (Pan-African) crustal accretion in the Precambrian crust of western Ethiopia and suggest further work towards a complete understanding of the geodynamic evolution of the belt.

## REGIONAL GEOLOGIC SETTING

The Precambrian basement of western Ethiopia, extending northwards from 6°N for about 650 km is the largest Precambrian block in Ethiopia (Fig. 1).

The Geological Survey of Ethiopia (GSE) studied the region at different scales (de Wit, 1977; Kazmin, 1978; Davidson, 1983; Abraham, 1984; Tefera, 1987; Tefera and Berhe, 1987; Ayalew and Moore, 1989) the results of which are summarized in the second edition of the 1: 2,000,000 scale geologic map of the country (Tefera *et al.*, 1996) and shown, simplified, for western Ethiopia, in Fig. 2. In outline, the Precambrian of western Ethiopia consists of high grade gneiss and migmatites in the east and west and low-grade metavolcano-sedimentary rocks at the center which are bounded in either sided by two parallel NNE-SSW trending ophiolitic belts (Tulu Dimtu and Asosa-Kurmuk). In more detail, Kazmin *et al.* (1979) divided the basement of western Ethiopia into five units. From east to west these are: Eastern block of high-grade Pre-Pan-African rocks (Zone I), Ophiolite belt (Zone II), Zone of dioritic-granodioritic batholiths and associated intermediate volcanics (Zone III), Metavolcanic-metasedimentary belt (Zone IV) and Western block of high-grade Pre-Pan-African basement (Zone V). He also suggested an east-dipping subduction zone for the tectonic setting of the rock units.

The high-grade gneiss and migmatites, which is also referred to as Lower Complex (Kazmin, 1972; UNDP, 1972) are considered as the northern continuation of the Pan-African Mozambique Belt. These rocks were regarded as Archean in age mainly on the basis of correlation with similar rocks in east Africa (Kazmin, 1972; Kazmin *et al.*, 1978). However, recent geochronological investigations indicate that the granitoids from the Lower complex fall within the time range of 550 to 810 Ma (Ayalew *et al.*, 1990; Kebede *et al.*, 2000) and some of the granitoids contain inherited zircon as old as 1571±9 Ma (Kebede *et al.*, 2000). This might suggest that the gneiss and migmatites are not juvenile Pan-African terrane but consist of Mesoproterozoic crust that was reworked in the East African Orogen. The low-grade metavolcano-sedimentary rocks referred to as Upper Complex (Kazmin, 1972; UNDP, 1972) have long been considered as the southern continuation of the Pan-African Arabian-Nubian Shield. Geochronological investigations from plutonic rocks suggest that the age of the low-grade rocks range from ~ 830 to ~ 540 Ma (Ayalew *et al.*, 1990). Based on field, lithologic, geochemical and geochronological evidence the low-grade rocks of western Ethiopia were correlated to the juvenile Pan-African assemblage of northern Ethiopia, Eritrea and the southeastern Sudan.

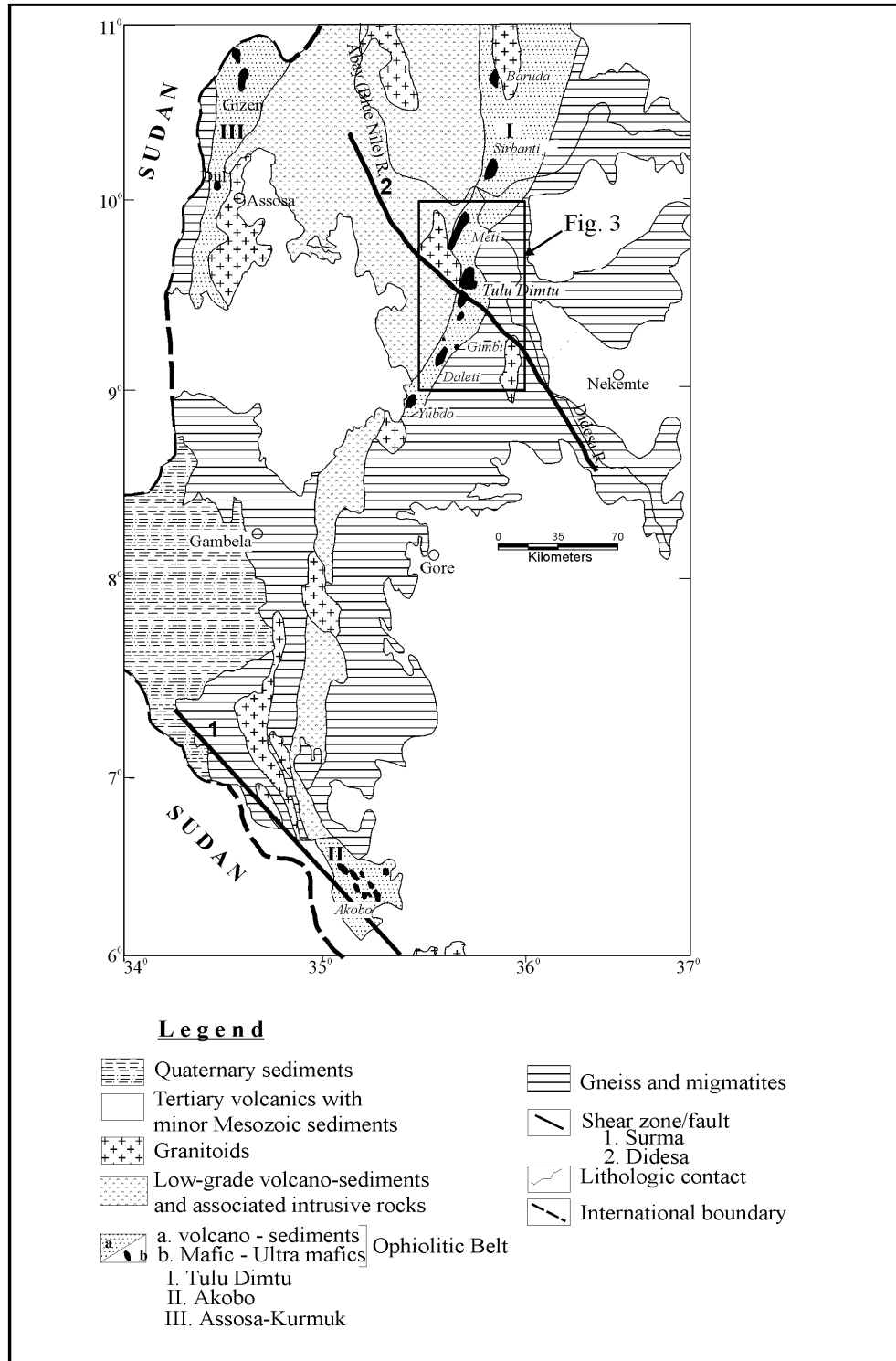

Fig. 2: Simplified geological map of the Precambrian of Western Ethiopia Block (modified after Tefera *et al.*, 1996 by Alemu and Abebe, 2000)

They were defined as the Tokar Terrane (Kröner *et al.*, 1991) and may correlate across the Red Sea to the southwestern part of the Asir Terrane of Saudi Arabia.

## LITHOLOGY

The Tulu Dimtu Belt and adjacent areas comprises a variety of lithological units, including gneisses and metamorphosed volcanic, volcanoclastic and sedimentary successions together with mafic-ultramafic and granitoid intrusions. Based on different patterns of deformation, metamorphism, volcanism and sedimentation, we divide the belt into five informal litho-tectonostratigraphic units that are separated from each other by tectonic discontinuities. From east to west these are: High-grade (amphibolite facies) gneiss and migmatites, Sayi Chenga Group, Tulu Dimtu Complex, Chochi Domain and Katta Domain (Fig. 3). Intrusive rocks ranging in composition from granite to gabbro variably intrude these units. The litho-tectonostratigraphic names are after Alemu (1999), Alemu and Abebe (2000).

**High-grade gneiss and migmatites:** This unit occupies the eastern part of the belt and consists of migmatitic biotite and biotite-hornblende gneiss and granitoid orthogneiss with subordinate quartzo-feldspathic gneiss and amphibolite. The main rock type is migmatitic biotite and biotite-hornblende gneiss, a dark to light gray, rarely mottled and commonly medium grained rock well exposed in quarry faces and road cuts along the Nekemt-Gimbi highway and in large river cliffs at Didesa and Sayi. The migmatite is weakly to strongly gneissose. The gneissosity is defined by the segregation of elongated felsic minerals and mafic minerals. The dip of the gneissosity varies from subhorizontal to vertical. Migmatitic phases are common, with mobilisates both as irregular quartzo-feldspathic segregations parallel to foliation and layering and as crosscutting veins and dykes of pegmatitic character. The granitoid gneiss is the other common rock type of the gneissic unit and forms rugged terrain with prominent topographic features. Compared to the migmatitic biotite and biotite-hornblende gneiss, the granitoid gneiss is uniform in outcrop and preserves relict granitic texture. It is usually gray, medium to coarse grained, well foliated and banded, although a transition from foliated and banded rocks to massive varieties is common. Compositionally, granite predominates, but minor tonalite and granodiorite are locally present.

The gneiss and migmatites are correlatable along strike to the south with the Geba Domain (Tefera and Berhe, 1987) and the Hamar Domain (Davidson, 1983) of

western Ethiopia. They have long been referred to as Alge gneiss and were considered Archean in age (Kazmin, 1972; Tefera *et al.*, 1996). There is no radiometric data from these rocks. However, the occurrence of an inherited Pb-Pb zircon date of  $1571 \pm 9$  Ma from Guttin granite (Kebede *et al.*, 2000) intruding the high-grade gneiss and migmatites east of the present study area, might suggest that the high-grade gneiss and migmatites represent a pre-Pan-African crust. Whether these gneisses are of Archean, Palaeoproterozoic, or Mesoproterozoic age must await further geochronological investigations.

**Sayi chenga group:** The Sayi Chenga Group structurally overlies the Tulu Dimtu mafic-ultramafic complex along a northwest-verging Tulu Dimtu Thrust Zone (TDTZ), but the relationship with the high-grade gneiss and migmatites is not clear and it is unknown whether the gneissic rocks are a basement unit or represent the migmatized, or synchronous plutonic equivalents of an arc terrane. The Sayi Chenga Group and the high-grade gneiss and migmatites were earlier grouped under the same litho-tectonic domain (Alemu and Abebe, 2000) but are here separated because of lithological association, deformation and degree of metamorphism. The difference in metamorphic grade (the upper amphibolite facies grade of metamorphism in the gneisses and the dominantly greenschist facies metamorphism in the Sayi Chenga Group) without noticeable tectonic break and moreover interpretation of the gneisses as pre-Pan-African continental crust may suggest a basement-cover relationship between the Sayi Chenga Group and the high-grade gneiss and migmatites. But this has not yet been proven.

Both metavolcanics and metasediments make up the Sayi Chenga Group, which is dominantly metamorphosed at upper greenschist facies, but locally attains amphibolite facies. Along shear zones the rocks are strongly foliated and crop out as chlorite schist. The basic metavolcanics that form the dominant part of the group are green to grayish green, fine-grained, massive to weakly foliated and jointed. They are composed of amphibole (actinolite and actinolitic hornblende), epidote, plagioclase, chlorite and minor amounts of calcite and opaques. In places, they exhibit ill-defined pillow structures and de Wit and Aguma (1977) reported the local occurrence of ultramafic lavas (komatite). Intermediate to acid volcanics are observed locally associated with the basic metavolcanics. The metasediments include: Quartzite and graphite schist, pelitic and semipelitic schists and phyllites and marble. Numerous lenses or pods of mafic-ultramafic rocks occur at many localities within the group. Serpentine,

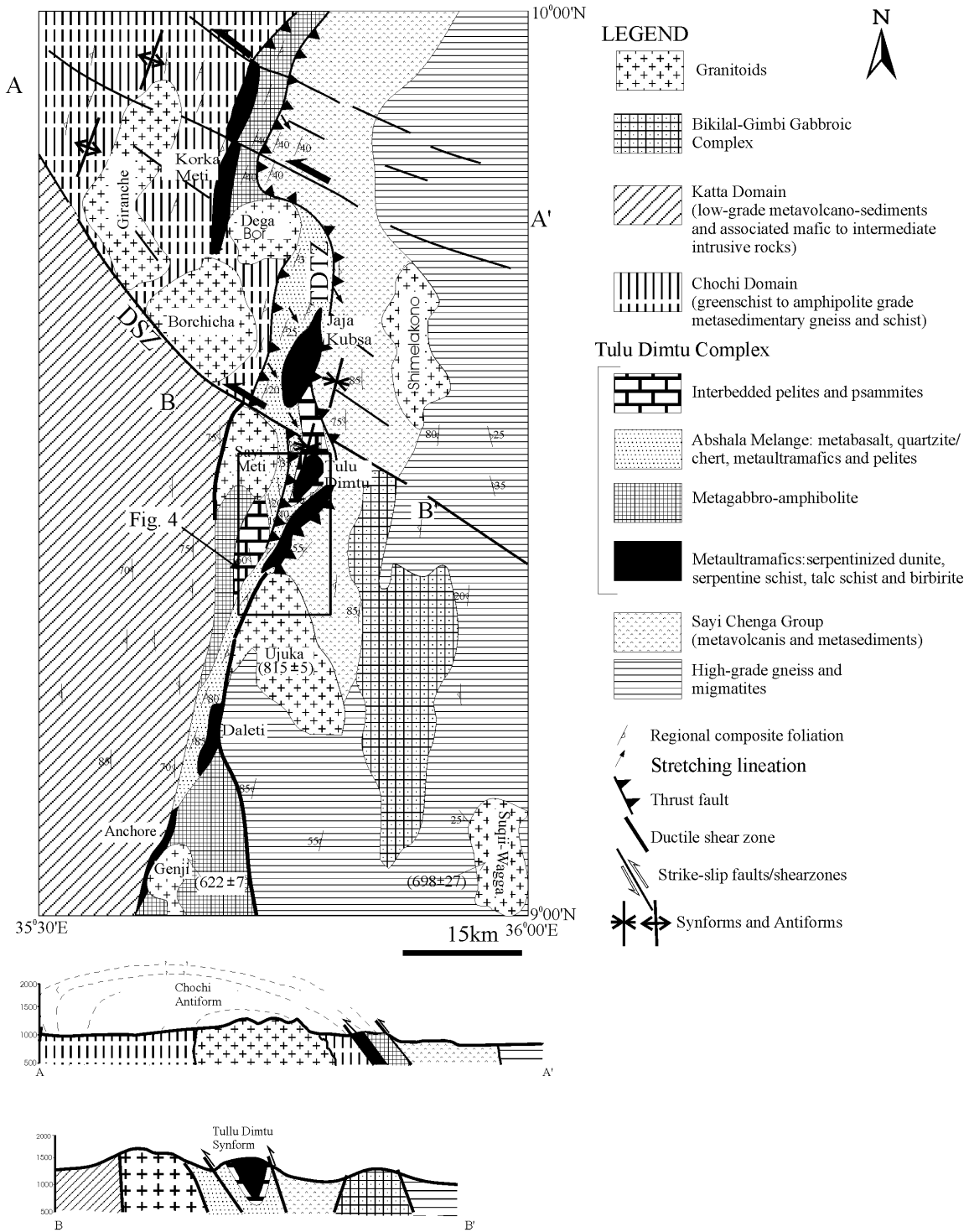

Fig. 3: Geological map of Tulu Dimtu Belt and adjacent areas (after Alemu and Abebe, 2000). TDTZ, Tulu Dimtu Thrust/Shear Zone; DSZ, Didesa Shear Zone. Geochronological data for granitoids after Kebede *et al.* (2000)

talc-serpentine schist and talc-chlorite schist represent the ultramafic rocks and mostly form concordant bodies from a few to tens of meters thick that appear to be interleaved with the surrounding metasediments. These mafic-ultramafic rocks are similar with those described in the Tulu Dimtu complex. Variably sheared and boudinaged metadoleritic dykes are also common and in places form swarms that are parallel to the foliation of the enclosing rocks.

The exposures of the Sayi Chenga Group show bulk lithological similarities to the Debesa metavolcanites of the Baruda shear belt further north in western Ethiopia (Braathen *et al.*, 2001). Geochemical investigations from the Debesa metavolcanites show chemical characteristics transitional between typical calc-alkaline series and MORB, typical of back-arc basin environments (Braathen *et al.*, 2001).

**Tulu dimtu complex:** The Tulu Dimtu complex is a NNE-SSW trending litho-tectonic unit that comprises metavolcano-sedimentary rocks and linear, but discontinuous, bodies of mafic-ultramafic rocks. It is bounded by major thrust faults and shear zones and separates the high-grade gneiss and migmatites and the Sayi Chenga Group in the east from the Katta and Chochi domains to the west (Fig. 3). Metamorphism is of lower to mid-greenschist facies but increases to amphibolite grade in the contact aureoles of granitoids.

The rock types exposed in the complex are divided into the following lithological units: Metaultramafics, metagabbro-amphibolite, quartzite, marble, Abshala Mélange and interbedded pelite and psammite.

**Metaultramafics:** This unit consists of serpentinized dunite, pyroxenite, serpentine schist, talc schist, talc-carbonate schist and tremolite-actinolite schist. These ultramafic rocks occur either in synforms and limbs of antiforms or as elongate masses conformable with the trend of foliation in the adjacent rocks (Fig. 3 and 4). The largest exposures of these metaultramafic rocks represented by serpentinized dunite, which forms prominent ridges almost devoid of vegetation. They are forming the cores and relatively massive parts of the ultramafic bodies that crop out at Tulu Dimtu, Daleti, Anchore and Jaja Kubsa (Fig. 3). Two such large homogeneous serpentinized dunites crop out in the Tulu Dimtu body. The largest is the Tulu Dimtu hill, which measures 6 by 3 km and the second one is situated 2 km south of Tulu Dimtu hill around Gidano Kingi (Fig. 4). The serpentinized dunite is dark green to pale green and brown when weathered, fine-grained, massive and compact and contains disseminated chromite

and magnetite. In thin sections the dunite is composed of 80-90% serpentine and 3-5% olivine with minor amounts of oxides and chlorite. In a few thin sections the olivine grains make up about 15% of the rock and occur as relics in the center of mesh and window structures suggesting that they are derived from chromitiferous dunite. The dunite is variably sheared and pervasively altered to serpentine schist, talc-carbonate schist and birbirite. Serpentine schists are common around the serpentinized dunite and along the thrust faults and shear zones that cut the body (Fig. 4). The schists are black or green to pale yellow, fine-grained and schistose and are composed of serpentine, which defines the schistosity and minor amounts of talc, tremolite and Fe-Ti oxides. Talc schist and talc-carbonate schist are fine-grained and schistose and readily identifiable in hand specimen by means of their softness and soapy feel. The talc schist is composed of talc with minor amounts of chlorite, tremolite, epidote and opaque. A thin band of talc-carbonate schist observed in the Tulu Dimtu body has tectonic contacts with the serpentine schist (Fig. 4). It is composed of talc, carbonate, epidote and minor amounts of opaques. Birbirite (silicified ultramafics) forms prominent ridges and flat surfaces. It is pale to dark brown, fine-grained and crops out in several places near the margins of the serpentinized dunite. The rock is similar to that described from the Yubdo ultramafics, where the name birbirite was first used (Duparc and Borloz, 1927). Pyroxenite is observed as thin bands a few centimeters to as much as a meter wide. Most are associated with the metaultramafics, but a few occur as magmatic segregations in some of the layered gabbros. The pyroxenite is medium to coarse grained, weakly foliated to massive and composed of entirely pyroxene which are partly to completely replaced by alteration assemblages consisting of greenschist facies minerals (actinolite, chlorite, epidote).

**Metagabbro-amphibolite:** This unit mostly forms elongate masses that have tectonic (shear) contacts with the metaultramafic rocks (Fig. 3 and 4). Metagabbro is the predominant rock type and is dark green to greenish green, coarse to medium grained and usually massive. However it is commonly sheared along major shear zones and therefore grades into amphibole-epidote-plagioclase schist and amphibolite. In places the gabbro exhibits compositional banding defined by feldspathic segregation ranging in thickness from few millimeters up to a meter. The metagabbro has a wide range of mineralogical composition and texture varying from rocks that show relict magmatic texture (ophitic and sub-ophitic) to rocks in which the primary mineralogy and texture are

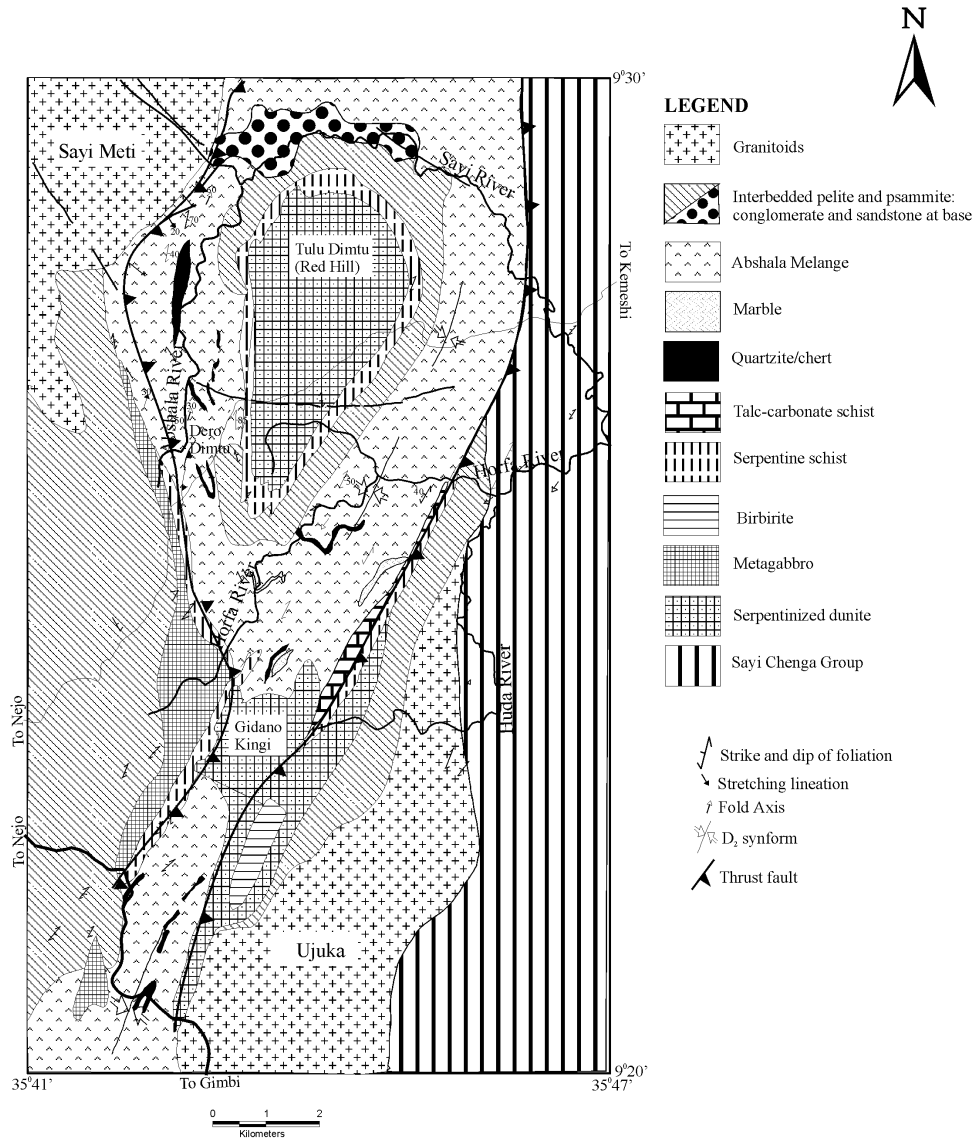

Fig. 4: Geological map of the Tulu Dimtu mafic-ultramafic body after (de Wit and Aguma, 1977; Alemu and Abebe, 2000)

completely obliterated by deformation and alterations. The rock is composed of clinopyroxene, partly to completely replaced by pale green amphibole and plagioclase that at the margins is altered to epidote. In places the gabbro grades into diorite. Amphibolite is closely associated with metagabbro but occurs also as thin intercalations in the metaultramafics. Based on mega and microscopic features, the amphibolite is divided into medium-grained and fine-grained varieties. The medium grained amphibolites are grayish black, schistose and consist of amphibole and plagioclase. In places they exhibit gneissose banding (up to 3 millimeters thick),

defined by segregation of plagioclase and amphibole. Fine-grained amphibolite, the most common rock type, is green to grayish green massive to strongly foliated and composed of green amphibole (actinolite) and plagioclase.

Metamorphosed dolerite dikes are common as thin intercalations within the above rock types. These dolerites are a few meters thick and of unknown extent. No chilled margins or indications of a sheeted-dike complex have been observed. Despite alteration, the dolerites have ophitic and subophitic textures and are composed of plagioclase, epidote, green amphibole, chlorite and opaques.



**Quartzite:** These are discontinuous bodies that can be traced for a few meters along strike (Fig. 4). At Korka Meti body they are closely associated with metaultramafic rocks and in the Abshala Mélange are interbedded with metabasalt. They are entirely composed of mosaic quartz with subordinate biotite, garnet and opaques. de Wit and Aguma (1977) interpreted these quartzites as metamorphosed chert.

**Marble:** Some thin bands of marble occur in the Tulu Dimtu body. The marble varies from pure white to pink and gray, fine- to medium-grained and massive to foliated.

**Abshala mélange:** Most of the mafic-ultramafic bodies in the complex are characterized by the development of mafic-ultramafic melanges. The best exposed is Abshala Mélange (Fig. 3 and 4). A mixture of metabasalt, quartzite/chert, mafic-ultramafics and pelites characterizes the Abshala Mélange. These rock types range in width from a few to several hundreds of meters and commonly occur as blocks chaotically jumbled against one another separated by thin screens of psammite and semi pelite. The metabasalt is grayish green to green, fine-grained and foliated. It is frequently observed interbedded with quartzite/chert. The metaultramafics are observed as lenses, bands or boudins of serpentinite, talc schist, talc-carbonate schist and pyroxenite. They range in thickness from a few to several hundreds of metres, apparently intercalated with the surrounding sediments. In places they are also observed as subangular to subrounded blocks set in a foliated and folded pelitic and metavolcanic matrix. The Abshala Mélange was previously mapped as Metavolcanic/sedimentary serpentinite unit (de Wit and Aguma, 1977) or Intercalations of metasediments and serpentinites of uncertain origin (Kazmin, 1978).

**Interbedded pelite and psammite:** Interbedded pelite and psammite represent the stratigraphically youngest part of the Tulu Dimtu complex. They are most prominent in the Tulu Dimtu body and occupy the Tulu Dimtu synform (Fig. 3 and 4) but also crop out to the west, where they are mapped as Guliso Formation of the Bila group (Alemu and Abebe, 2000). They comprise interbedded psammite and pelite that show a facies variation, from coarser (conglomerate and sandstone) at the base to finer (shale and mudstone) at the top. The succession is divided into lower and upper units. The lower unit comprises conglomerates and sandstones with subordinate graphite schist and quartzite. Substantial horizons of conglomerates are mapped north of the Tulu Dimtu hill in the Sayi River (Fig. 4) (de Wit and Aguma, 1977; Kazmin, 1978). The conglomerate contains clasts of the

underlying mafic-ultramafic and associated rocks. The clasts are elongated due to deformation and range from 1 to 30 centimeters in diameter. The sandstone consists of various proportions of quartz arenite, arkose and greywacke. It is fine- to medium grained, weakly foliated and composed of quartz, sericite, chlorite, chloritoid and minor amounts of stilpnomelane, opaque and muscovite. The sandstone also contains clasts of ultramafic rocks and clastic grains of chromite. The upper unit is characterized by varying amounts of quartz-sericite schist, quartz-muscovite schist, chlorite schist, shale, quartzite/chert and marble and comprises a fine-grained, laminated and foliated unit up to 150 m thick. Most of these rocks are crenulated and contain porphyroblasts of cordierite and chloritoid that grew in a late stage of crenulation cleavage formation. The cordierite and chloritoid porphyroblasts probably developed during late thermal overprinting associated with late- to post-tectonic granitic and gabbroic/dioritic intrusions.

The association of ultramafic rocks, gabbro, metabasalt and possible chert suggests that the Tulu Dimtu mafic-ultramafic complex represent an ophiolitic assemblage. The mutual juxtaposition of these rocks embedded in a chaotic matrix of metavolcano-sediments suggests that the Tulu Dimtu complex is an ophiolitic mélange. The Tulu Dimtu mafic-ultramafic rocks have long been interpreted as disrupted ophiolite (Kazmin, 1976, 1978; de Wit and Aguma, 1977; Warden *et al.*, 1982; Berhe, 1990). Apart from a preliminary geochemical investigation from the Tulu Dimtu body by Warden *et al.* (1982) which suggests a back-arc setting, there are no geochemical data from other mafic-ultramafic bodies in the area. Recently, Mogessie *et al.* (2000) and Braathen *et al.* (2001) argue against the ophiolitic origin of these mafic-ultramafic rocks and they interpret them as intrusions in metavolcano-sediments. Mogessie *et al.* (2000) interpret them as intrusions that show concentric zoning typical of Alaskan type intrusion. However, this interpretation is unlikely for the following reasons; the mafic-ultramafic rocks in the area occur as elongate masses that are in tectonic contact with the surrounding rocks or in faulted  $D_2$  synforms, geochemical investigations from these rocks, albeit limited, show a signature of island arc and MORB chemistry, typical for rocks emplaced in a back-arc setting (Warden *et al.*, 1982). In any case the fragments of these mafic and ultramafic rocks may have been formed in a variety of oceanic environments including: oceanic floor, fracture zones, back-arc basins, seamounts and oceanic arc. Therefore, detailed geochemical and reliable geochronological data are required for better understanding of the geodynamic evolution of the complex.

**Chochi domain:** The Chochi Domain structurally underlies the Tulu Dimtu complex along a northwest-verging thrust fault. It comprises a variety of schists and gneisses that are metamorphosed from upper greenschist to mid-amphibolite facies. It is intruded by voluminous granitoid intrusions (Fig. 3). The domain is divided into two lithological associations: a gneissic association, which is represented by various proportions of biotite-hornblende gneiss, hornblende gneiss, calc-silicate gneiss, quartzofeldspathic gneiss with subordinate marble and amphibolite and a pelitic and psammo-pelitic schist consisting of garnet-mica schist, mica-quartz-feldspar schist, biotite-kyanite-quartz schist with subordinate chlorite schist, graphite schist, quartzite, marble and amphibolite. Minor lenses and pods of mafic-ultramafic rocks occur in many places having tectonic contacts with the above rock types.

The Chochi domain extends to the north outside the area of this study and appears to be correlatable with the Mora metasediments of Braathen *et al.* (2001) and Gesengesa schists and gneisses of Tefera (1991). To the south it terminates against the Didesa Shear Zone (DSZ), which separates the Chochi domain from the Katta domain (Fig. 3). Similar rock types to the Chochi domain are also mapped further west outside the area (Afa Domain; Alemu and Abebe, 2000).

**Katta domain:** The Katta domain is represented by low-grade (greenschist facies) metasedimentary and metavolcanic rocks and associated intrusive rocks ranging in composition from gabbro to granite. The domain is bounded by the Tulu Dimtu complex in the east and separated by the DSZ from the Chochi domain (Fig. 3). The domain consists mostly of various closely interlayered metavolcanics and metasediments. Owing to the scarcity of outcrops (due to thick soil cover) no complete sequence of these rocks was found exposed at any place. Thus, it is not possible to estimate the true proportions of the various rock types. The metavolcanics, mainly basic, are dark green or greenish gray, massive to foliated, sometimes porphyritic with phenocrysts of amphibolitized and chloritized pyroxene and plagioclase. In places they are associated with chlorite, chlorite-actinolite and talc schists and amphibolites. Closely interlayered Phyllite and schists represent metasedimentary units. Phyllite is the most common rock type. It is grayish green to grayish pink, fine-grained and laminated and commonly has a lustrous sheen that is striped with black graphitic bands. Large crystals (up to 2 mm) of pyrite are abundant along narrow shear bands. Elsewhere the pyrite crystals are fine-grained and disseminated. The phyllite is composed of sericite, quartz,

chlorite, feldspar, graphite, opaques, accessory carbonate and, as observed in a few thin sections, as much as 10% epidote (mainly zoisite). The phyllite is generally characterized by grano-lepidoblastic texture; however, along shear zones, where strongly deformed, the rock grades to phyllonite. The various schists in the Katta domain are light to dark gray and dark green and fine to occasionally medium grained. They are strongly schistose and often crenulated. Compositionally they include graphite-sericite-quartz schist, graphite schist, mica schist and chlorite schist with subordinate graphitic quartzite and quartzite. Graphite-sericite/muscovite-quartz schist is the most common rock type and is light gray to pinkish gray, fine-grained, laminated and foliated and composed of quartz, sericitic muscovite, graphite, opaque and minor amounts of stilpnomelane, chlorite and garnet. A strong deformation has produced transposed metamorphic layering and the rocks are observed as discontinuous outcrop. In a few thin sections as much as 4% garnet and 10% stilpnomelane are observed.

On the basis of gross lithological similarities, the Katta domain appears to be correlatable along strike to the south with the Birbir Domain of Tefera and Berhe (1987). Geochemical investigations from these rocks indicate that they are of magmatic are type (Ayalew and Moore, 1989).

### Intrusive rocks

**Mafic to intermediate intrusions:** Mafic to intermediate intrusions form the dominant part of the Katta Domain and are not shown in Fig. 3 for the sake of simplicity. They range in composition from gabbro through diorite to quartz diorite and tonalite. Gabbro and diorite make up the dominant part of the intrusions and are gray to greenish gray, medium to coarse grained and leucocratic to mesocratic with color index ranging from 25 to 45. They are variably sheared and along major shear zones occurred as amphibolite. The gabbro is composed of plagioclase, pyroxene, amphibole, opaques, biotite with trace amounts of apatite and sphene. Pyroxene is replaced to varying degrees by subsolidus, clear acicular amphiboles. The gabbro has granular, porphyritic and blastoporphyratic texture. The diorite is composed of plagioclase, amphibole, biotite with minor amounts of pyroxene and opaque and trace amounts of quartz, apatite and K-feldspar. The quartz diorite, the other common rock type after gabbro and diorite, is gray to grayish white, medium grained and leucocratic to mesocratic with color index ranging from 20 to 40. It is composed of plagioclase, amphibole, biotite, quartz and minor amounts of opaque, epidote and K-feldspar. Apatite, zircon and sphene are the common accessory minerals. The quartz diorite locally grades to tonalite.

Mafic to intermediate intrusions in the area are probably correlatable to the south with the Birbir intrusive complex in Gore-Gambella area (Ayalew and Moore, 1989) and to the north with the Kilaji intrusion of the Baruda shear belt (Braathen *et al.*, 2001) in western Ethiopia. Geochemical investigations from the Birbir intrusive complex indicate that the rocks are of magmatic-arc type and originated from a primitive mantle-derived melt (Ayalew and Moore, 1989), whereas geochemical investigations from the Kilaji intrusions showing a range from high-K calc-alkaline rocks to transitional types with a minor MORB affinity (Braathen *et al.*, 2001). Ayalew *et al.* (1990) obtained a U-Pb zircon date of  $828 \pm 5$  Ma and  $814 \pm 2$  Ma for Birbir intrusive complex.

**Granitoid intrusives:** The granitoid intrusives in the belt are represented by eight separate plutons: Borchicha, Dega Bor, Genji, Giranche, Sayi Meti, Shimelakono, Suqii-Wagga and Ujuka (Fig. 3). They are circular, sub-circular and elliptical in shape and appear to have been emplaced pre-, syn/late- to post-tectonically with respect to the major deformational events. Modally, the granitoids range from rare diorite/gabbro through dominant granodiorite and monzogranite. The Ujuka and Suqii-Wagga granitoid lie east of the Tulu Dimtu complex. The Ujuka granitoid, dated by the Pb-Pb zircon method at  $815 \pm 5$  Ma (Kebede *et al.*, 2000), intrudes the high-grade gneiss and migmatites and the Sayi Chenga Group, but has a tectonic (shear) contact with the Tulu Dimtu Complex (Fig. 3). It is granite and granodiorite with subordinate tonalite and quartz diorite. The rock is deformed and shows well-developed NE-trending foliation, although less pronounced in the central part of the intrusion, suggesting that the pluton experienced at least part of the  $D_1$  and  $D_2$  deformational history of the TDB. It is interpreted as a pre/syn-tectonic intrusion. The Ujuka granitoid show calc-alkaline affinities, which are similar to plutonic rocks generated in arc-related environment (volcanic arc granite) (Kebede *et al.*, 1999). The Suqii-Wagga granitoid is a garnet bearing two-mica granite composed of quartz, K-feldspar, plagioclase, biotite and muscovite with subordinate garnet and opaques. It is emplaced into the high-grade gneiss and migmatites and has a gradational contact with the surrounding gneiss and migmatites, in which some of the migmatitic biotite gneiss is incorporated within the intrusion. This suggests that the Suqii-Wagga granite may be the granitized part of the gneiss, an interpretation that is supported by mineral and whole rock major and trace element chemistry (Kebede *et al.*, 2001), which indicates that the Suqii-Wagga granite has the characteristics of anatectic granite, similar to a

Syn-collision granite. Kebede *et al.* (2000) also dated the Suqii-Wagga granite and reported a Pb-Pb zircon age of  $698 \pm 27$  Ma. The Giranche and Borchicha granitoids are situated west of the Tulu Dimtu complex and occupy the core of the Chochi antiform north of the DSZ (Fig. 3). They are cut by the DSZ and contain a fabric related to this deformation, but the interiors of the intrusions are largely unaffected by the  $D_1$  and  $D_2$  deformation. This suggests that the granites are syntectonic intrusions, with fabrics suggesting emplacement before  $D_3$  but after the  $D_1$  and  $D_2$  deformation. Monzogranite and granodiorite form the dominant parts of the granitoid, composed of quartz, plagioclase, perthitic K-feldspar, biotite and minor amounts of opaques, hornblende and epidote. Accessory minerals are represented by zircon, sphene, apatite and orthite. The Dega Bor granitoid lies close to the Tulu Dimtu complex and intrudes both the Tulu Dimtu complex and the Chochi domain. It is a muscovite granite composed of subequal amounts of quartz and K-feldspar and subordinate plagioclase and muscovite. The granitoid is interpreted as a syntectonic intrusion, with fabrics suggesting emplacement before  $D_3$  but after  $D_1$  and  $D_2$ . The Genji granitoid lies within the Tulu Dimtu complex and is a medium-grained, pink, biotite granite composed of quartz, K-feldspar, plagioclase and biotite. The pluton is free of planar fabric and is interpreted as a post-tectonic intrusion. The Genji granite was dated by Kebede *et al.* (2000) who reported Pb-Pb zircon age of  $622 \pm 7$  Ma. The Sayi Meti and Shimelakono plutons are dioritic in composition. The Sayi Meti pluton intrudes the Tulu Dimtu complex, but appears to have a faulted (shear) contact with the Katta domain (Fig. 3). The pluton consists of plagioclase, amphibole and minor amounts of quartz, biotite, pyroxene and opaques and is affected by sericite, chlorite, epidote, calcite and actinolite alteration. The Shimelakono pluton is quartz monzodiorite/diorite and intrudes the Sayi Chenga Group. It has a uniform grain size up to the contact, which, where observed, is sharp and contains country rock xenoliths. The rock is composed of plagioclase, K-feldspar, biotite, hornblende and accessory minerals such as apatite, opaques and sphene.

**Bikilal gimbi gabbroic complex:** The complex is situated east of the Tulu Dimtu mafic-ultramafic complex and appears to have an intrusive contact with the gneiss and migmatites and the Sayi Chenga Group (Fig. 3). The complex has an elliptical shape in outline measuring 42 km in length and 3 to 11 km in width and forms the elongated Bikilal Gimbi Chuta Keki mountain range. It consists in large part of gabbro, amphibole gabbro and olivine gabbro with subordinate leuco gabbro, anorthosite and hornblende.

## STRUCTURES

The Tulu Dimtu Belt is exposed as a NNE-trending fold and thrust belt, which can be traced for the entire length of the study area and continues north and south as part of the proposed Pan-African Barka-Tulu Dimtu suture (Fig. 1). Field relations suggest that the belt is affected by three phases of Deformation ( $D_1$  to  $D_3$ ).

**$D_1$  deformation:** The main structural element, developed during  $D_1$  deformation, is a NNE-SSW striking and variably Southeast dipping foliation ( $S_1$ ) ranging in inclination from subhorizontal to sub vertical (Fig. 3 and 6).  $S_1$  is axial planar to  $D_1$  folds of primary layering (Fig. 5a), suggesting that the foliation is formed by transposition of primary layering. In the high-grade gneiss and migmatites, the foliation ( $S_1$ ) parallels folded gneissic layering and quartzofeldspathic layer and leucosome in migmatite suggesting that gneissic banding is formed earlier than that of  $D_1$  deformation (pre- $S_1$  foliation).

$D_1$  folds are preserved as mesoscopic tight, isoclinal and recumbent folds (Fig. 5a and b). They verge to the northwest and variably plunge between  $5^\circ$  and  $10^\circ$  to the northeast and southeast.

The other structure of  $D_1$  deformation is a major southeast dipping shear zone characterized by oblique to down-dip southeast plunging stretching lineations. The shear zone has northwest verging minor folds and asymmetric boudins and clasts (Fig. 3 and 5c), which suggest a top to the northwest tectonic transport direction. On this basis, the structure is interpreted as a northwest verging zone of thrust faults/shear zones and is herein referred to as the Tulu Dimtu Thrust/Shear zone (TDTZ). The TDTZ varies in width from outcrop scale (Fig. 5c) to a kilometer. It can be traced for the entire length in the belt (Fig. 3) and appears to continue in the north to the Baruda shear belt (Braathen *et al.*, 2001). The TDTZ is generally NNE-SSW striking and variably southeast dipping. The attitude of the thrust plane differs in mode and intensity of development throughout the belt, namely shallow to moderate dipping ( $15^\circ$  -  $45^\circ$ ) in the north and steeply dipping ( $70^\circ$  -  $90^\circ$ ) in the south. This is presumably a result of  $D_2$  deformation. The thrust zone separates rock units belong to entirely different environments and grade of metamorphism. It separates the ophiolitic-like rocks (Tulu Dimtu mafic-ultramafic and associated rocks) from rock units characterized by continental material (Chochi domain; Sayi Chenga group), which attain upper greenschist to mid-amphibolite facies metamorphism. Sheared ultramafic, gabbro and quartzite that developed mylonitic fabric occupy the surface trace of these thrust faults.

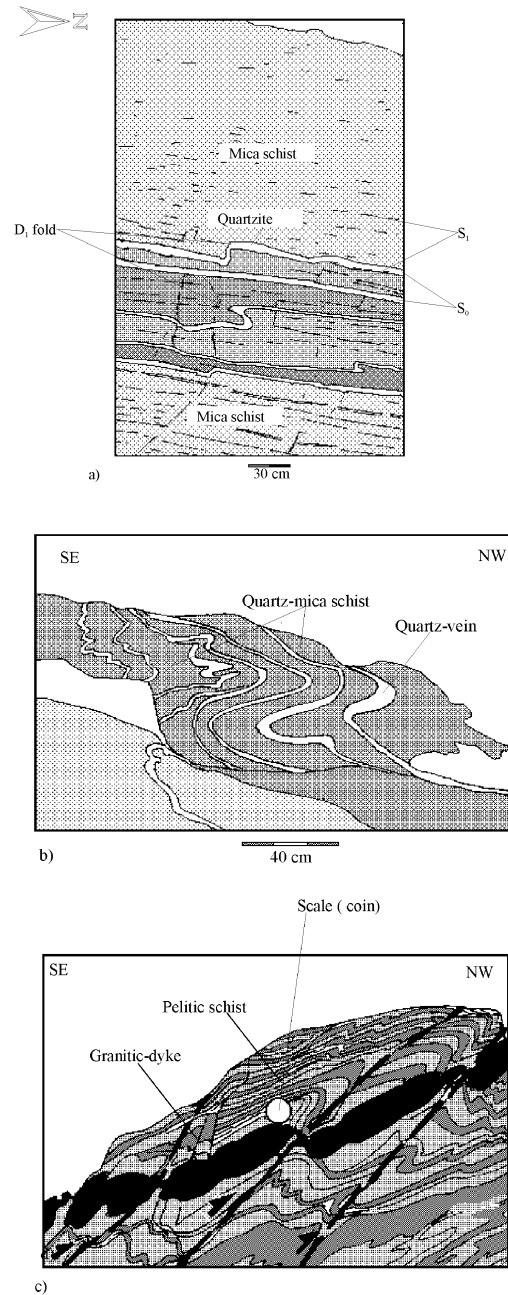

Fig. 5:  $D_1$  Structures traced from field photographs. (a) Tightly folded quartzite within the interbedded mica schist and quartzite in Sayi Chenga group. Note that foliation ( $S_1$ ) is parallel to the axial plane of  $D_1$  fold. (b) Tight to open recumbent  $D_1$  fold from the Chochi domain. (c) NW-verging folds and thrusts in TDTZ. Diameter of the coin (Ethiopian fifty cents) is 2.5 cm

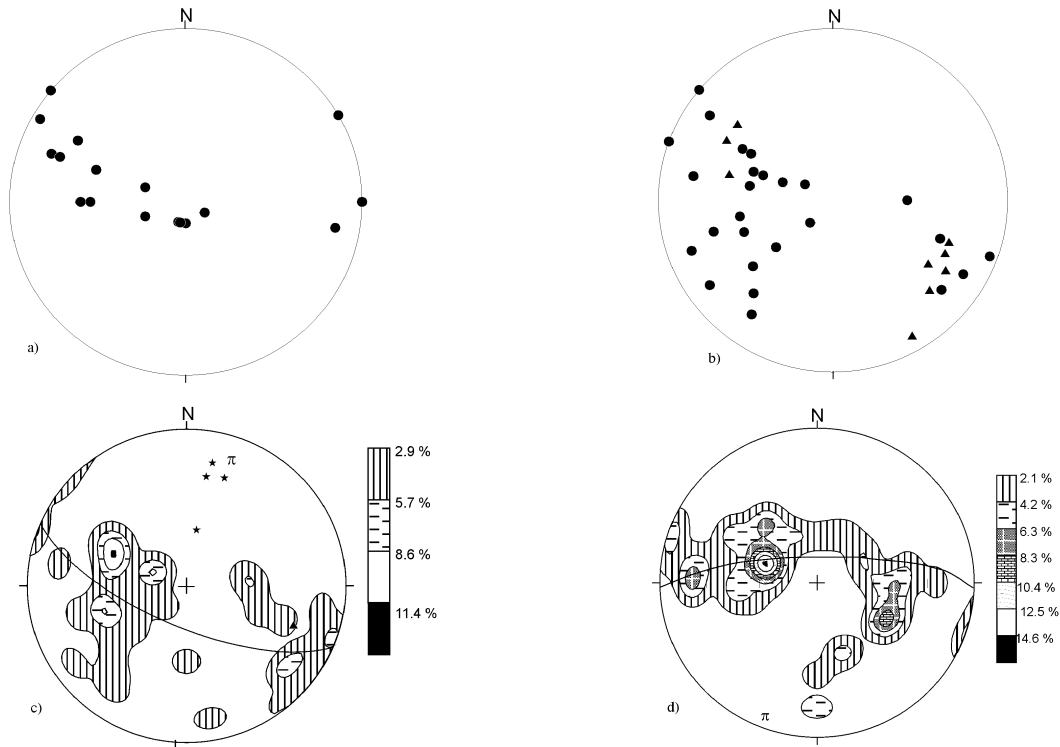

Fig. 6: (a) Lower hemisphere equal area stereonet plot of poles to  $S_1$  foliation from the Sayi Chenga group. (b) Lower hemisphere equal area stereonet plot of poles to  $S_1$  foliation (dots) and stretching lineations  $L_1$ (triangles) from the Tulu Dimtu complex. (c)  $\pi$ -diagram of  $S_1$  foliation ( $n = 35$ ) and  $D_2$  fold axes (stars) from the Tulu Dimtu synform. (d)  $\pi$ -diagram of  $S_1$  foliation ( $n = 71$ ) from the Chochi antiform

**D<sub>2</sub> deformation:**  $D_2$  deformation is characterized by the development of tight to open upright folds at both mappable (Fig. 4) and smaller scales in which bedding planes ( $S_0$ ) and  $S_1$  foliation are folded around NNE-trending axes. These are also consistent with an equal area  $\pi$ -diagram (poles to main foliation) in the Tulu Dimtu complex, which defines a great circle girdle whose  $\pi$ -axis plunges  $22^\circ$  towards 020 (Fig. 6c).  $D_2$  folds are occasionally accompanied by weakly to strongly developed crenulation cleavage ( $S_2$ ) axial planar to the  $D_2$  folds. In zones of strong deformation, the  $S_1$  is completely transposed by  $S_2$  and it is difficult to distinguish  $S_1$  from  $S_2$ .

Two major  $D_2$  folds were mapped in the belt. These are the Chochi antiform and the Tulu Dimtu synform (Fig. 3). The Tulu Dimtu synform is a NW-verging, NE-plunging synform (Fig. 6c). The position of the stratigraphically youngest Interbedded pelite and psammite unit below the mafic-ultramafic unit (cross-section B-B' in Fig. 3) may suggest that the Tulu Dimtu synform is upside down. The Chochi antiform is a

NW-verging and SW-plunging antiform (Fig. 3 and 6d). The axial trace of the antiform is traced for about 10 km and dies north and southward along the axial trace, where the relationship is obscured due to granitoid intrusions.

**D<sub>3</sub> deformation:** N-, NNE- and NW-trending brittle-ductile strike-slip faults/shear zones represent  $D_3$  deformation. In incompetent rocks, strain was partitioned along zones dominated by ductile process, whereas in more competent mica poor quartzofeldspathic rocks, closely spaced brittle-ductile fracture arrays have developed. N- and NNE-trending strike-slip shear zones vary in width from a few meters to a kilometer and appear to continue in the south to the N-trending Birbir shear zone in Gore-Gambela area (Ayalew and Moore, 1989). They bound the Tulu Dimtu complex on either side separating the complex from high-grade gneiss and migmatites and the Katta domain (Fig. 3) and are characterized by an extensive development of mylonite zones ranging from few centimeters up to 3 to 5 km in width. At an early stage the shear zones truncated and disrupted the  $D_2$  fold limbs. Continued

shearing resulted in the transposition of  $D_2$  folds and the development of rootless intrafolial  $D_2$  folds within the shear zones. Kinematic indicators within the shear zone show a dominantly sinistral sense of movement, however, dextral sense of movement has also been encountered in a few localities along the shear zones.

The other major structure of  $D_3$  deformation is the NW-trending Didesa Shear Zone (DSZ), which is a major boundary between the Chochi and Katta domains (Fig. 3). In places, the shear zone measures up to 10 km wide and is marked by strong mylonitic fabric. Within the major shear zone all pre-existing planar fabrics ( $D_1$  and  $D_2$ ) have been transposed and are mutually parallel, trending NW-SE. Steeply plunging S-folds, rotated porphyroclasts and S-C fabrics indicate that the sense of movement in the DSZ is sinistral. However, the juxtaposition of rock units contrast in metamorphic grade (the dominantly greenschist facies Katta domain and the mid-amphibolite facies Chochi domain) across the shear zone suggests a component of dip-slip motion. It is difficult to estimate the exact magnitude of offset along the shear zone, although separation of the Katta and Chochi domains, as shown in Fig. 3, implies more than 30 km offset on the DSZ.

The DSZ has long been referred to as Didesa lineament (Vail, 1983). At regional scale the DSZ can be traced across western Ethiopia (Fig. 2) and appears to have a strike continuation to the northwest to the Ingessana hills of the Sudan (Fig. 1) (Vail, 1983). To the south and east the DSZ continues as far as the Adola lineament (Fig. 1) (Kazmin *et al.*, 1978, Kozyrev *et al.*, 1985) in southern Ethiopia, which sinistrally displaces the Adola-Moyale ophiolites (Fig. 1). Beyond, to the southeast, the shear zone continues to the Mutito fault zone of Kenya, which has a length of 1,600 km. The Didesa shear zone is also similar with other northwest trending faults/shear zones observed in the East African Orogen, the Surma shear zone of western Ethiopia (Fig. 2; Davidson, 1983), the Najd fault system of Saudi Arabia (Fig. 1) (Moore, 1979; Agar, 1987; Stern, 1985), the Marda fault belt (Fig. 1) (Berhe, 1986) and the Aswa shear zone (Cahen and Snelling, 1966).

## DISCUSSION

**Structural interpretation:** The TDB is a prominent deformational belt in the ANS comprising a NNE-trending fold and thrust belt. Its structural evolution, schematically shown in Fig. 7, is interpreted as due to oblique compression (transpression), resulting in significant NW-SE directed shortening across the belt. Based on the relationships between foliations, folds and shear zones, three phases of Deformation ( $D_1$ ,  $D_2$  and  $D_3$ ) are recognized.

The early phase of Deformation ( $D_1$ ) is characterized by northwest verging thrust faults/shear zones (TDTZ) and folds. The asymmetry of structures in the TDTZ indicates an oblique (top to northwest) sense of movement, believed to be related to the obduction of the Tulu Dimtu ophiolites as thrust sheets.  $D_2$  deformation, which is the progressive continuation of  $D_1$ , deformed the initially subhorizontal TDTZ about more upright folds without changing the orientation of the compressive stress axis.  $D_3$  deformation reflects extensive shortening that culminated in the formation of N- and NE-trending shortening zones and the NW-trending sinistral DSZ. The structural elements associated with the TDTZ are consistent with contraction and at map scale the shear zone shows no offset, whereas, the DSZ is characterized by distinctive sinistral offset indicating a transcurrent shear regime. These differences between TDTZ and DSZ might be due to one of the following reasons: Both TDTZ and DSZ could have been formed by the same orogenic event related to oblique collision, which imposed an overall NW-SE compression that induced a sinistral transpression. Sinistral transpression would partition into major contractional and subordinate conjugate strike-slip deformation. TDTZ and DSZ could have been formed by different orogenic event in which the TDTZ related to collision and the DSZ related to an intra-plate deformation in the form of left-lateral strike-slip faults.

The geometrical relationships between  $D_1$ ,  $D_2$  and  $D_3$  in the TDB as shown in Fig. 7 favors the proposition in which the TDB was developed as due to oblique collision in response to a NW-SE compressional stress, which induced a sinistral transpression. However, indications based on variations in metamorphic grade that the DSZ includes a component of dip-slip would also be consistent with formation of the DSZ during extension following a major episode of collision. NW-trending structures similar to the DSZ elsewhere in the East African Orogen are interpreted as transform faults developed in response to a major episode of extension (Stern, 1985; de Wit *et al.*, 2001). Unfortunately, the present structural data are not adequate to address properly these differences and their resolution will depend on future detail structural studies supplemented by geochemistry and geochronology.

At this stage, we note that evolution of the TDB as due to oblique collision has also been suggested by de Wit and Chewaka (1981), Berhe (1990), Abdelsalam and Stern (1996), Braathen *et al.* (2001) and agrees with conclusions of other studies of deformational belts in the ANS Baruda shear belt (Braathen *et al.*, 2001) Barka suture (Drury and Berhe, 1993) Keraf suture (Abdelsalam *et al.*, 1995; 1998), Nabitah orogenic belt (Quick, 1991).

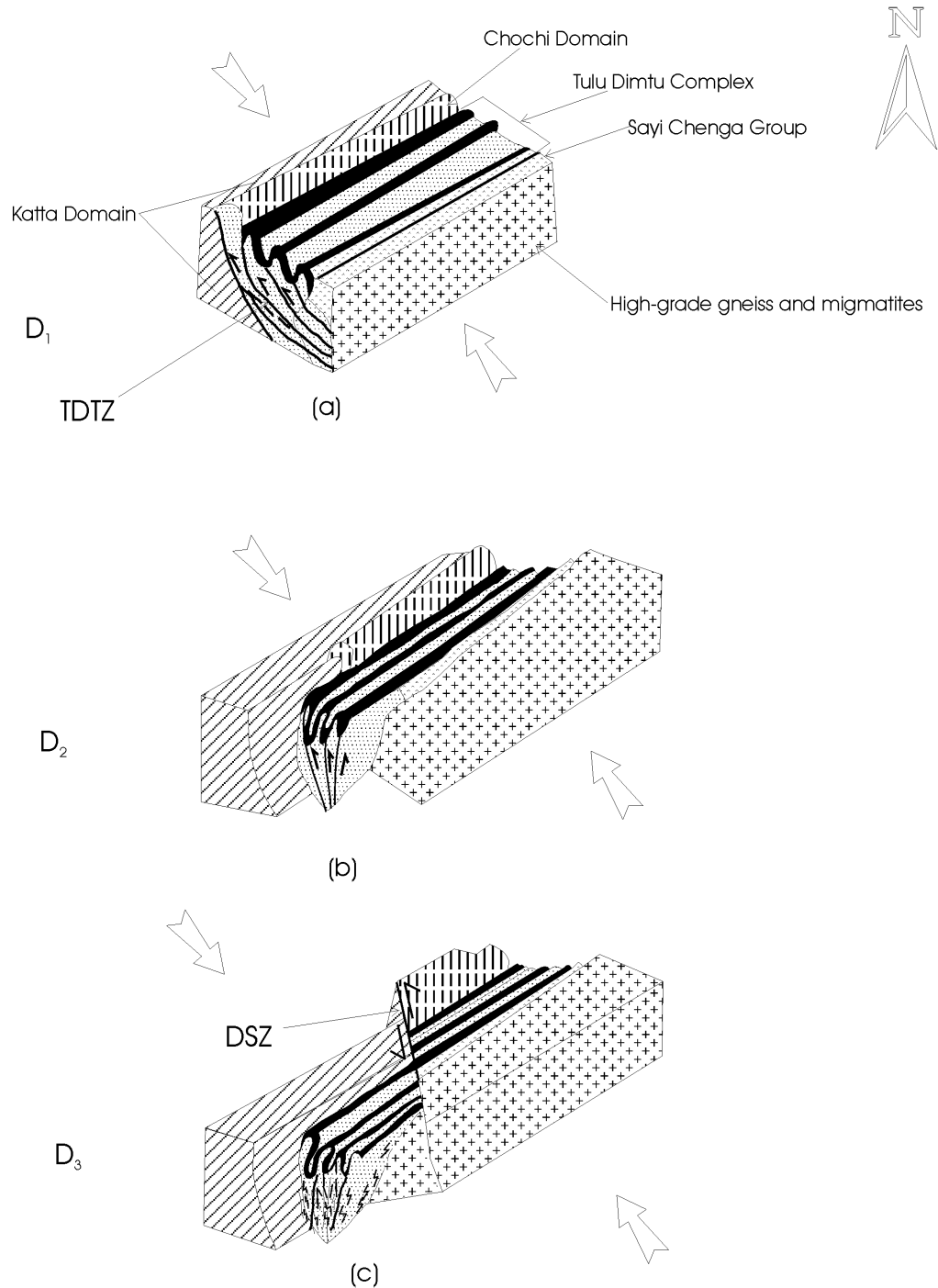

Fig. 7: Schematic block diagram showing the structural evolution of the Pan-African Tulu Dimtu Belt (TDB). (a) Early deformation (D<sub>1</sub>), which resulted in the development of northwest-verging folds and associated thrust faults/shear zones (TDTZ). (b) D<sub>2</sub> deformation, which is resulted in deforming the initially subhorizontal D<sub>1</sub> structures about more upright folds. (c) D<sub>3</sub> deformation represents extensive shortening, which resulted in the formation of N- and NNE-trending ductile shear zone and NW-trending sinistral Didesa Shear Zone (DSZ)

**Tectonic interpretation:** The field, lithologic and structure descriptions in the preceding sections show that the TDB consists of five litho-tectonic units separated by tectonic discontinuities. The relationship between the Sayi Chenga Group and the high-grade gneiss and migmatites situated east of the Tulu Dimtu mafic-ultramafic complex is not clear and it is unknown whether the gneissic rocks are basement to the Sayi Chenga rocks during a period of crustal extension, represent the migmatized equivalent or synchronous plutonic equivalents of an arc terrane, or are an accreted segment in their own right. The presence of Mesoproterozoic inherited zircons from granite emplaced into the gneisses Guttin granite (Kebede *et al.*, 2000) and the emplacement of syn-collision Suqii-Wagga garnet-bearing two-mica granite (Kebede *et al.*, 2001) in the migmatized gneiss suggest that the high-grade gneiss and migmatites are likely pre-Pan-African continental crust. However, Pb-Pb zircon studies of granites emplaced into the high-grade gneiss and migmatites by Kebede *et al.* (2000), who reported an age of  $815 \pm 5$  Ma for Ujuka granitoid and  $698 \pm 27$  Ma for Suqii-Wagga granitoid, suggest that they were reworked during the Pan-African orogen.

The existence of doleritic dikes in the Sayi Chenga Group is permissive of a period of crustal extension and rifting. However, there is no geochemical data indicating that the volcanics are rift related. Geochemical investigations from the Debesa metavolcanites (Braathen *et al.*, 2001), which appear to be similar in bulk lithological associations with the Sayi Cheng Group, show a signature of island arc and MORB chemistry, typical for rocks emplaced in a back-arc setting. Therefore, reliable geochemical data are required for a better understanding of the paleoenvironment of the Sayi Chenga Group.

The Chochi domain is characterized by terrigenous and clastic sediments metamorphosed in the upper greenschist to mid-amphibolite facies and present as interlayered quartzofeldspathic schist/gneiss, biotite-hornblende gneiss, pelitic schists, calc-silicate gneiss, quartzite and marble. The volumetrically abundance of clastic rocks in the sequence suggests a passive continental margin setting.

The low-grade (greenschist facies) metavolcano-sedimentary rocks and associated mafic to intermediate intrusives of the Katta domain are interpreted as forming in an island-arc. Geochemical and isotopic studies on similar rocks further south in western Ethiopia Birbir domain (Ayalew and Moore, 1989; Ayalew *et al.*, 1990) indicate a juvenile origin with no involvement of older basement.

The presence of dismembered ophiolites in the Tulu Dimtu complex implies that a tract of oceanic (back-arc)

basin existed between the island arc assemblage Katta domain and the high-grade gneiss and migmatites. The northwesterly sense of thrusting of the Tulu Dimtu ophiolites and the northwesterly vergence of the major structures of the Chochi domain are consistent with a SE-dipping subduction zone during the tectonic evolution of the Pan-African TDB. Braathen *et al.* (2001) proposed a SE-dipping subduction zone for the tectonic evolution of the Baruda shear belt and Drury and Berhe (1993) suggested an east-dipping major subduction zone along the Barka suture to account for the development of the Pan-African rocks of Eritrea. Kazmin *et al.* (1979) based mainly on field data, inferred an east-dipping subduction zone for the Precambrian rocks of western Ethiopia. However, Ayalew *et al.* (1990), Ayalew and Moore (1989) on the basis of field, geochemical and geochronological data suggested a west-dipping subduction zone for the same rocks involving oceanic crust, represented by the Tulu Dimtu ophiolite and subduction-related magmatism at about 820 Ma. Whether the Tulu Dimtu Belt evolved over the east-dipping or west-dipping subduction zone must await further geological investigations (reliable geochemical and geochronological data).

De Wit and Chewaka (1981), Berhe (1990), Abdelsalam and Stern (1996) suggest an arc-arc collision for the evolution of the belt, by analogy with ophiolitic sutures situated north of the belt Barka suture (Berhe, 1990; Drury and Berhe, 1993) and considered it as a possible pan-African suture now referred to as Barka-Tulu Dimtu-Yubdo-Sekerr (Berhe, 1990) or Barka-Tulu Dimtu (Fig. 1) (Abdelsalam and Stern, 1996) suture zone. In this context it must be noted that the TDB includes: low angle thrust faults and mafic-ultramafic rocks preserved in synformal structures, on the limbs of antiforms and as tectonic slices in supracrustal rocks, rocks disposed in either side of the Tulu Dimtu mafic-ultramafic complex that are genetically related rather than exotic and Mesoproterozoic inherited zircons in the Genji granite ( $1323 \pm 42$  Ma) (Kebede *et al.*, 2000) situated along the TDTZ and in the Guttin granite ( $1571 \pm 9$  Ma), which intrudes the high-grade gneiss and migmatites. In our opinion, these features suggest that pre-Pan-African crust underlies the TDB and that the rocks on either side of the TDB are not distinct terranes. Interpretation of the TDB as a suture is therefore not valid. Alternatively, we propose that the Tulu Dimtu ophiolitic assemblage represents a northwest-transported nappe not a suture zone. Our interpretation of the TDB as not marking a suture zone is similar to the conclusion of Braathen *et al.* (2001) with respect to the Baruda shear belt. However, we are differing from



Braathen *et al.* (2001) concerning the interpretation of the tectonic setting of the mafic-ultramafic complexes. We interpret the mafic-ultramafic rocks as far-traveled tectonic fragments of oceanic crust, whereas Braathen *et al.* (2001) interpret them as solitary intrusions in an arc and back-arc setting which underwent continental collision and tectonic shortening. Our interpretation of the Tulu Dimtu ophiolites as far-traveled tectonic fragments agrees with observations in other parts of the East African Orogen, where most of the ophiolitic occurrences are interpreted as far-traveled nappe complex (Shackleton, 1996).

### CONCLUSION

A precise plate tectonic setting of the TDB is speculative, since reliable geochemical and geochronological data are yet not complete from the belt. However, on the basis of present field, lithologic and structural data and correlations with the other studies in the region, we propose that the tectonic evolution of the Pan-African Tulu Dimtu belt includes the following elements:

- The high-grade gneiss and migmatites likely represent Pre-Pan-African crust that was uplifted and eroded during a period of crustal extension and formed basement to a supracrustal sequence. The age of rifting is not known in the region, but rifting is weakly constrained in the northern part of the EAO (Egypt, Sudan, Saudi Arabia) at about 900 to 800 Ma (Stern, 1993, 1994).
- Initiation of a southeast-dipping subduction zone led to the development of the Katta domain as an intra-oceanic island arc. U-Pb and Pb-Pb zircon dates of 820 to 830 Ma obtained for arc-related intrusives in western Ethiopia (Kebede *et al.*, 2000; Ayalew *et al.*, 1990) may approximate the initiation of subduction in the area. The subduction probably overlapped in space and time with emplacement of Tulu Dimtu ophiolites in the oceanic (back-arc) basin.
- All the above rocks were deformed and metamorphosed during D<sub>1</sub>, D<sub>2</sub> and D<sub>3</sub> deformations. Some geochronological investigations in and around the TDB including: Pb-Pb zircon ages of 627±7 Ma obtained from the post-tectonic Genji granite located along TDTZ and 815±5 Ma obtained from the pre/syn-tectonic Ujuka granite west of the TDTZ (Fig. 3) (Kebede *et al.*, 2000) and Rb-Sr reset ages constraining development of the N-trending Birbir shear zone located south of TDTZ at about 635 Ma (Ayalew *et al.*, 1990), may bracket deformation in TDB to sometime between 800 and 620 Ma.

- D<sub>1</sub> and D<sub>2</sub> were related to oblique (top-to-the-northwest) collision and transport of the Katta domain with the high-grade gneiss and migmatites. Collision resulted in the closure of an oceanic (back-arc) basin and northwestward obduction of the Tulu Dimtu ophiolites, remnants of which are preserved as allochthonous mafic and ultramafic slices in the supracrustal sequences. This collision occurred between approximately 670 and 725 Ma, as implied by the Pb-Pb zircon intrusion age of the syn-collision Suqii-Wagga granite (Fig 3) (Kebede *et al.*, 2001).
- Continued shortening during D<sub>3</sub> deformation, resulted in overprinting of D<sub>1</sub> and D<sub>2</sub> structures by N-and NNE-trending shortening zones and NW-trending sinistral strike-slip shear zones. This phase of deformation may be related to final continent-to-continent collision/continent-to-continent convergence between East and West Gondwana and on the basis of Rb-Sr reset ages of 635 Ma obtained from 780-760 Ma syn-tectonic granites in the Birbir shear zone (Ayalew *et al.*, 1990) occurred at about 635 Ma.
- The Pan-African history in the TDB ceased by the emplacement of late- to post-tectonic intrusives, which in western Ethiopia range from 540 to 570 Ma (Ayalew *et al.*, 1990).

### ACKNOWLEDGMENT

The geology of the area discussed in this paper is based on fieldwork carried out by members of the Regional Geology and Geochemistry Department (RGGD) of the GSE during the course of mapping the Gimbi Sheet and regional compilation by Alemu and Abebe (2000). Our understanding of the geology was greatly assisted by discussions with Dr. Tarekegne Tadesse (Head, RGGD) and the late Professor B. Sturt (NGU). The early draft of the manuscript was carefully and thoroughly reviewed by de Wit M.J. and R.O. Greiling, resulting in a significant improvement in scientific content and readability. Especially, we are grateful to M.J. de Wit for his wealth of helpful suggestions and for sharing his knowledge on the geology of the area. We are very much indebted to Peter Johnson for helping to improve the language of study and reviewing a revised version of the manuscript, whose suggestions greatly improved the quality of the study. At last, but not least we are very much grateful to Ms. Sofanit Girma for her endless patience in digitizing the figures.

## REFERENCES

- Abdelsalam, M.G. and R.J. Stern, 1996. Sutures and shear zones in the Arabian-Nubian Shield. *J. Af. Earth Sci.*, 23: 289-310.
- Abdelsalam, M.G., R.J. Stern, H. Schandelmeier and M. Sultan, 1995. Deformational history of the Keraf Zone in NE Sudan, revealed by shuttle Imaging Radar. *J. Geol.*, 103: 475-491.
- Abdelsalam, M.G., R.J. Stern, P. Copeland, E.M. Elfaki, B. Elhur and F.M. Ibrahim, 1998. The Neoproterozoic Keraf Suture in NE Sudan: Sinistral Transpression along the Eastern Margin of West Gondwana. *J. Geol.*, 106: 133-147.
- Abraham, A., 1984. Preliminary draft geological map (1:250,000) of Gimbi Sheet (NC36-12). Ethiopian Institute of Geological Surveys.
- Agar, R.A., 1987. The Najd fault system revisited: A two-way strike-slip orogen in the Saudi Arabian Shield. *J. Struc. Geol.*, 9: 41-48.
- Alemu, T., 1999. Preliminary Note on the Geology of Eastern Gimbi sheet. Ethiopian Institute of Geological Surveys, News Letter, Vol. 10/1.
- Alemu, T. and T. Abebe, 2000. Geology of the Gimbi area. Geological Survey of Ethiopia, Memoir, 15: 156.
- Ayalew, T. and J.M. Moore, 1989. The Gore-Gambella Geotraverse, Western Ethiopia. Open file report, IDRC, pp: 153.
- Ayalew, T., K. Bell, J.M. Moore and R.R. Parrish, 1990. U-Pb and Rb-Sr geochronology of the Western Ethiopian Shield. *Geolog. Soc. Am. Bull.*, 102: 1309-1316.
- Bakor, A.R., I.G. Gass and C.R. Neary, 1976. Jabal Al Wask, Northwestern Saudi Arabia: Eocambrian Back-arc ophiolite. *Earth and Planetary Sci. Lett.*, 30: 1-19.
- Berhe, S.M., 1986. Geologic and geochronological constraints on the evolution of the Red Sea-Gulf of Aden and Afar Depression. *J. Af. Earth Sci.*, 5: 101-117.
- Berhe, S.M., 1990. Ophiolites in northeast and east Africa: Implication for Proterozoic crustal growth. *J. Geolog. Soc. Lon.*, 147: 41-57.
- Braathen, A., T. Grenne, M.G. Selassie and T. Worku, 2001. Juxtaposition of Neoproterozoic units along the Baruda-Tulu Dimtu shear-belt in the East African Orogen of western Ethiopia. *Precambrian Res.*, 107: 215-234.
- Cahen, L. and N.J. Snelling, 1966. The geochronology of equatorial Africa. North Holland Pub. Comp.
- Camp, V.E., 1984. Island arcs and their role in the evolution of the west Arabian Shield. *Geolog. Soc. Am. Bull.*, 95: 24-48.
- Davidson, A., 1983. The Omo River Project: Reconnaissance geology and geochemistry of parts of Illababor, Kefa, Gamu Gofa and Sidamo, Ethiopia. *Ethiopian Inst. Geological Surveys Bull.*, 2: 89.
- de Wit, M.J., 1977. Notes on the Geology of part of Sheet NC36-16 (Gore). *Ethiopian Inst. Geol. Surveys*, 51: 17.
- de Wit, M.J. and A. Aguma, 1977. Geology of the ultramafic and associated rocks of Tulu Dimtu, Welega. *Ethiopian Inst. Geol. Surveys*, 57: 28.
- de Wit, M.J. and R. Berg, 1978. Ni, Pt and Cr mineralizations at Tulu Dimtu, Welega. *Ethiopian Institute of Geological Surveys Report*.
- de Wit, M.J. and S. Chewaka, 1981. Plate tectonic evolution of Ethiopia and its mineral deposits: An overview. In: Chewaka, S. and M.J. de Wit (Eds.), *Plate Tectonics and Metallogenesis, Some Guide Lines to Ethiopian Mineral Deposits*. Ethiopian Inst. Geol. Surveys Bull., 2: 115-119.
- de Wit, M.J., S.A. Bowring, L.D. Ashwal, L.G. Randrianasolo, P.I. Morel and R.A. Rambelson, 2001. Age and tectonic evolution of Neoproterozoic ductile shear zones in southwestern Madagascar, with implications for Gondwana studies. *Tectonics*, 20: 1-45.
- Drury, S.A. and S.M. Berhe, 1993. Accretion tectonics in the northern Eritrea revealed by remotely sensed imagery. *Geol. Mag.*, 130: 177-190.
- Duparc, L. and A. Borloz, 1927. Sur la Birbirite, une roche nouvelle. *Comp. Rend. Soc. Phys. His. Nat.*, Geneva, pp: 44.
- Duyvermann, H.J., 1984. Late Precambrian granitic and volcanic rocks and their relation to the cratonisation of the Arabian Shield. *Faculty of Earth Sci. Bul. King Abdulaziz University, Jeddah*, 6: 50-69.
- Gass, I.G., 1977. The evolution of the Pan-African Basement in NE Africa and Arabia. *J. Geol. Soc. Lon.*, 134: 129-138.
- Greenwood, W.R., D.G. Hadley, R.F. Anderson, J.R. Fleck and D.L. Schmidt, 1976. Late Proterozoic cratonisation in southwestern Saudi Arabia. *Roy. Soc. London Phil. Trans.*, A280: 517-527.
- Jackson, N.J., 1986. Petrogenesis and evolution of Arabian felsic plutonic rocks. *J. Af. Earth Sci.*, 4: 47-59.
- Kazmin, V., 1969. Geology of Tulu Kapi-Daletti area. *Ethiopian Institute of Geological Surveys Report*.
- Kazmin, V., 1972. Geology of Ethiopia. Unpublished report, Ethiopian Institute of Geological Surveys.
- Kazmin, V., 1976. Ophiolite in the Ethiopian basement. *Ethiopian Institute of Geological Surveys*.
- Kazmin, V., 1978. Geology of the Tulu Dimtu area, Welega. *Ethiopian Institute of geological Surveys Report*.

- Kazmin, V., A. Shiferaw and T. Balcha, 1978. The Ethiopian basement stratigraphy and possible manner of evolution. *Geol. Rundschau*, 67: 531-546.
- Kazmin, V., A. Shiferaw, M. Tefera, S.M. Berhe and S. Chewaka, 1979. Precambrian structure of Western Ethiopia. *Ann. Geol. Surv. Egypt*, 9: 1-18.
- Kebede, T., C. Koeberl and F. Koller, 1999. Geology, geochemistry and Petrogenesis of intrusive rocks of the Welega area, western Ethiopia. *J. Af. Earth Sci.*, 29: 715-734.
- Kebede, T., U.S. Kloetzli and C. Koeberl, 2000. Single grain zircon Pb-Pb ages and evolution of granitoid magmatism in western Ethiopia. *J. Af. Earth Sci.*, 30: 45.
- Kebede, T., C. Koeberl and F. Koller, 2001. Magmatic evolution of the Suqii-Wagga garnet-bearing two-mica granite, Wallagga area. *J. Af. Earth Sci.*, 32: 193-221.
- Kozzyrev, V., K. Girma, Y.U. Safanov, W.M. Bekele, G. Gurbanovich, T. Tewelde Medhin, M. Kaitvkv and A. Ariyapov, 1985. Regional geological and exploration work for gold and other minerals in the Adola gold field. EMRDC Vol. II, Addis Ababa, Ethiopia.
- KrÖner, A., 1985. Ophiolites and the evolution of tectonic boundaries in the late Proterozoic Arabian-Nubian Shield of Northeast Africa and Arabia. *Precambrian Res.*, 27: 277-300.
- KrÖner, A., R.J. Stern, P. Linnebacker, W. Manton, T. Reischmann and I.M. Hussien, 1991. Evolution of Pan-African island arc assemblages in the south Red Sea Hills, Sudan and in SW Arabia as exemplified by geochemistry and geochronology. *Precambrian Res.*, 53: 99-118.
- Mogessie, A., K.H. Belete and G. Hoinkes, 2000. Yubdo-Tulu Dimtu mafic-ultramafic belt, Alaskan-type intrusions in western Ethiopia: Its implication to the Arabian-Nubian Shield and tectonics of the Mozambique Belt. *J. Af. Earth Sci.*, 30: 62.
- Moore, J.M., 1979. Tectonics of the Najd transcurrent fault system, Saudi Arabia. *J. Geol. Soc. Lon.*, 136: 441-453.
- Quick, J.E., 1991. Late Proterozoic transpression on the Nabitah fault system: Implications for the assembly of the Arabian Shield. *Precambrian Res.*, 53: 119-147.
- Roobal, M.J., C.R. Ramsay, N.J. Jackson and D.P.F. Darbyshire, 1983. Late Proterozoic lava of the Central Arabian Shield-evolution of an ancient volcanic arc system. *J. Geol. Soc. Lon.*, 140: 185-202.
- Shackleton, R.M., 1979. Precambrian tectonics of northeast Africa. *Institute Applied Geology Bulletin, King Abdulaziz University, Jeddah*, 3: 1-6.
- Shackleton, R.M., 1996. The final collision between East and West Gondwana: Where is it? *J. Af. Earth Sci.*, 23: 271-287.
- Stern, R.J., 1985. The Najd fault system, Saudi Arabia and Egypt: A late Precambrian rift-related transform system? *Tectonics*, 4: 497-511.
- Stern, R.J., 1993. Tectonic evolution of the Late Proterozoic East African Orogen: Constraints from crustal evolution in the Arabian-Nubian Shield and the Mozambique Belt. *Geoscientific Research in Northeast Africa*, by Thorihe and Schandeimeier (Eds.), pp: 73-74.
- Stern, R.J., 1994. Arc assembly and continent collision in the Neoproterozoic East African Orogen: implication for the consolidation of Gondwanaland. *Ann. Rev. Earth Planetary Sci.*, 23: 289-310.
- Stoeser, D.B. and V.E. Camp, 1985. Pan-African microplate accretion of the Arabian shield. *Geol. Soc. Am. Bull.*, 96: 817-826.
- Tefera, M., 1987. Geological map of Kurmuk-Asosa, (1:250 000). Ethiopian Institute of Geological Surveys.
- Tefera, M., 1991. Geology of the Kurmuk and Asosa area: Preliminary report. Ethiopian Inst. Geol. Surveys, pp: 112.
- Tefera, M. and S.M. Berhe, 1987. Geological map of Gore area (1:250,000). Ethiopian Institute of Geological Surveys.
- Tefera, M., T. Cherenet and W. Haro, 1996. Geological map of Ethiopia (1:2, 000, 000). Ethiopian Institute of Geological Surveys.
- UNDP, 1972. Mineral survey in two selected areas (Sidamo and Welega), Ethiopia.
- Vail, J.R., 1983. Pan-African crustal accretion in northeast Africa. *J. Af. Earth Sci.*, 1: 285-294.
- Vail, J.R., 1985. Pan-African (late Precambrian) tectonic terrains and the reconstruction of the Arabian-Nubian Shield. *Geology*, 13: 839-842.
- Warden, A.J., V. Kazmin, W. Kiesel and W. Pohl, 1982. Some geological data of the mafic-ultra mafic complex at Tulu Dimtu, Ethiopia and their genetic significance. *Oesterr. Ak. Wiss. Mathem.-Naturw. Kl. Abt.*, 191: 1-4.