

Methodological Principles of Agglomeration Processes Improvement in Technologies of Disperse Materials Processing

Maxim Vladimirovich Sevostyanov, Tat'yana Nikolaevna Il'ina,
Vladimir Semenovich Sevostyanov and Dmitriy Aleksandrovich Emel'anov
Belgorod State Technological University Named after V.G. Shukhov,
Kostyukov Street 46, 308012 Belgorod, Russia

Abstract: The classification of agglomeration processes and their value in technologies of disperse materials processing is presented. The formation of relations between particles at agglomeration is considered, the role of the superficial phenomena in disperse systems and powdery material properties in processes of various structures formation is shown. The methodological principles of improvement of agglomeration processes of disperse materials with various physical and chemical properties and methodology of carrying out researches are offered. According to the results of complex researches the classification of disperse materials is developed and the recommendations about the organization of their agglomeration processes depending on the offered dispersion indicator are made. The practical significance of the developments is confirmed by the patent protected design of the apparatus and devices and their use in technological modules for by-products processing in order to their recycling and the environmental protection from harmful emissions.

Key words: Agglomeration, disperse by-products, specific surface, dispersion indicator, granulation, preconsolidation, terminal velocity

INTRODUCTION

Agglomeration processes which are carried out by the pelletizing, extruding or briquetting methods are used as a rule in order to receive the set quality product in technologies of the disperse materials processing in many industries. The choice of a method depends on physical and chemical properties of powdery materials, their dispersion, requirements to physical and mechanical parameters of a ready-made product and other factors (Il'ina, 2009a). The increasing volume of powdery waste during the manufacturing of the construction materials and products determines the need of their utilization by the compacting method (Zagorodnyuk *et al.*, 2010; Gridchin *et al.*, 2007, 2006; Il'ina and Gibelev, 2009). However, some problems of polydisperse materials agglomeration are insufficiently studied now and have to be solved. It concerns the value of the materials agglomeration capacity and the choice of the rational compaction method, the technological sheaves selection, the value of their quality and expense definition of the granulated mixes, the choice of processing equipment and the modes of its work taking into account the demanded quality indicators of a ready-made product. It is actual especially due to the involvement of man-made materials production for the purpose of their utilization and receiving the granulated product.

MAIN PART

Agglomeration is a complex of physical and physicochemical processes providing bodies formation of certain sizes, forms, necessary structure and physical parameters. The agglomeration of disperse materials is carried out to improve the quality of both intermediate and ready-made products in many industries.

The considerable scientific and practical experience in the sphere of disperse materials formation with receiving colloidal, capillary and porous bodies is obtained nowadays (Klassen *et al.*, 1991; Evtushenko *et al.*, 2009; Min'ko *et al.*, 2008). It should be noted that the term agglomeration used in this work has broader concept in comparison with traditional one representing agglomeration as "a thermal way of the ore mixture pelletizing to improve its metallurgical properties due to the small fuel burning in the material at the continuous leakage air".

Agglomeration in the disperse systems can happen without influence of external forces so-called spontaneous agglomeration which is carried out at transportation, storage, warehousing of polydisperse materials. The formation of agglomerates happens also in air streams of aspiration systems in the weighed fluidized layer, during drying in drying drums (Fig. 1).

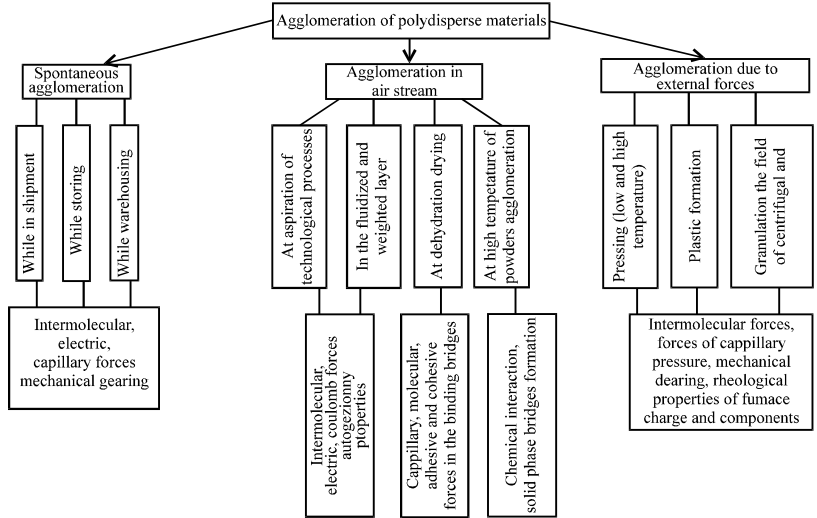

Fig. 1: Classification of agglomeration processes

The processes of compacted bodies formation due to the influence of external forces belong to the most extensive group. These are as follows: granulation in the field of centrifugal and vibration forces, plastic formation, low and high temperature pressing. The binding formation is caused by the action of intermolecular forces, capillary pressure, electric, adhesive and cohesive forces (Sulimenko and Albats, 1994; Il'ina, 2009b; Lotov *et al.*, 2006).

In all cases the free and disperse unstructured system passes into the binding disperse system with coagulative, condensation or crystallizational structures. The prevalence of a certain type of structure depends on the existence and properties of binding additives, a way of agglomeration and temperature impacts on the system (Fig. 2).

The agglomeration in disperse systems can't be presented without the superficial phenomena. According to the first and second order integrated equation of thermodynamics all superficial phenomena can be written down in the form of the increment of Gibbs energy as the sum of increments of thermal, mechanical, superficial energy and also chemical reactions energy and electric forces action. These increments go with such phenomena as adhesion, wetting, adsorption and capillarity. At agglomeration superficial energy always aspires to a minimum and is followed by the surface area reduction due to the larger particles formation.

The size, form, size particles distribution determine the properties of a powdery material and the formed body (Fig. 3).

The compacted bodies formation from powdery materials is carried out in various devices. These are devices with a fluidized layer in which the process of

agglomeration is combined with drying or cooling, chemical interaction, classification of the granulated product. The granulation can be carried out by a pressing method in Vibration Action Devices or Pelletizing Method.

Each of these ways and devices has the advantages and shortcomings and finds the practical application depending on the properties of the disperse materials and also the tactical requirements to the granulated product.

Due to the special attention to the fuel economy and energy resources, need of the maximum use of technogenic materials to ensure the environmental protection from pollution and also need of the development of the methodological principles of the improvement and agglomeration processes of hardware providing which arises the tendency of the development of the small and medium business enterprises. The methodological principles include:

Regulation of the superficial phenomena at spontaneous agglomeration taking into account the mechanism of adhesive and cohesive interaction of components of heterogeneous systems to decrease in dust emissions and the environmental protection against pollution.

Quality improvement of the granulated production due to the regulation of properties and the expense of the technological sheaves, development of the recommendations about the conducting technological process depending on physical and chemical properties of disperse materials and the requirements to the agglomerate quality.

Constructive and technological improvement of the devices for the polydisperse materials granulation on the basis of the researches of the stepwise pellet formation in the disperse systems.

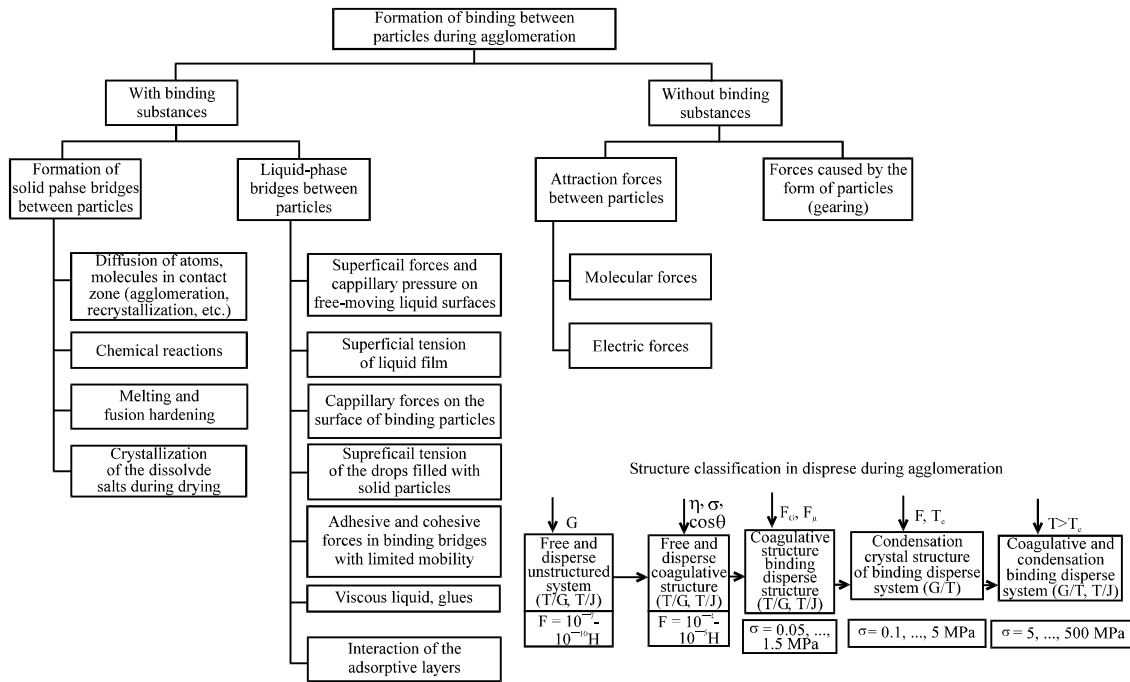

Fig. 2: Classification of bindings and structures in disperse systems at agglomeration

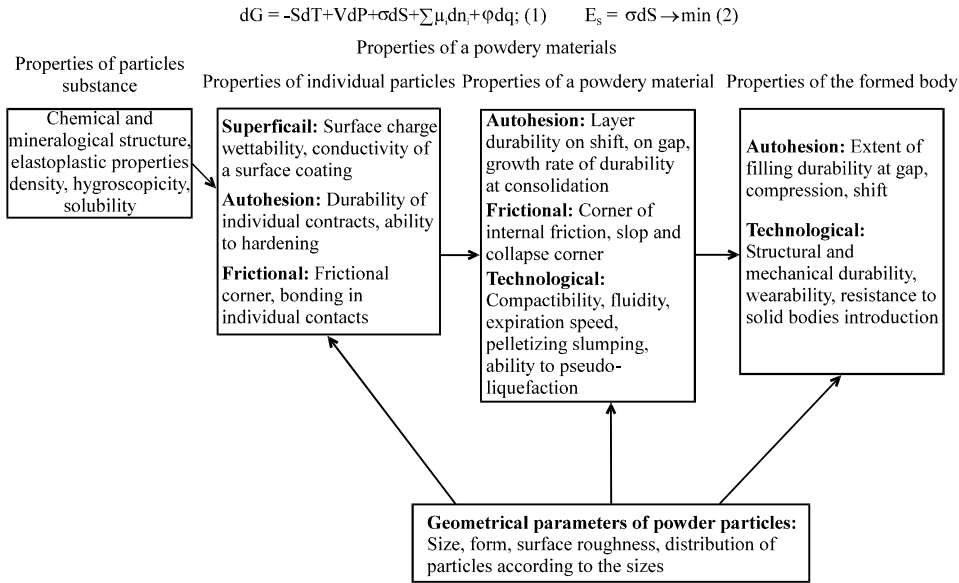

Fig. 3: Thermodynamic interpretation of the superficial phenomena in disperse systems

According to the purpose and the relevance degree of various problems of the agglomeration the researches methodology is chosen which includes:

Theoretical researches of the granules structured processes at their stepwise formation, the mechanical model development of the compaction process with practical realization in the form of the patent protected designs of granulators.

Rheological researches of the models of colloidal and capillary porous bodies and the model dispersive environments with the development of the methodology of the quality assessment of binding materials and the method of decrease in their expense that is especially important for iron ore pellets production.

Research of the agglomeration processes and the development of the methods of the dust loss decrease

during open transportation, warehousing and storage of disperse materials and also at the drying stage of raw slimes of cement production.

Research of agglomeration processes of technogenic materials with the development of low-tonnage technological complexes of multipurpose action for the production of granulated production.

The theoretical researches of compaction processes of disperse materials conducted by us revealed their general regularities. The stagewise formation of compacted bodies as a result of elastic and visco-plastic deformation of furnace charge is presented in the form of the Mechanical Models (Fig. 4) made of elements of Guk. Newton, Saint-Venant, Maxwell, Calvin, Poynting-Thompson's bodies, Kulona-Deryagina (Sevost'yanov *et al.*, 2013).

The experimental studies of the granulation processes of disperse materials with various physic and mechanical characteristics proved the need of the stage of preliminary consolidation of furnace charges with a low bulk density (<200 kg m⁻³) for their subsequent formation in the field of centrifugal forces (Sevost'yanov *et al.*, 2014).

The choice of the forming equipment and the technological schemes of the compaction processes depends on the physical, chemical and rheological properties and the composition of polydisperse furnace

charges, requirements to a ready-made product can be carried out on the basis of the system analysis (Makarenkov *et al.*, 2013).

As a rule the materials demanding compaction have various mineralogical structure, dispersion, bulk density at natural hygroscopic humidity, adhesiveness and other parameters. The coefficient is often used to assess the consolidation ability of the materials:

$$\kappa_{ver}^{max} = \frac{\rho_{ver}}{\rho_{bulk}} \tag{1}$$

To compare the disperse materials we offer to use the average characteristic of the dispersion (dispersion indicator of K_d) considering the nature of a disperse material (ρ_{ver} kg m⁻³) and the area of the specific surface of a disperse material (S , m²/kg), depending on the way of its preparation:

$$\kappa_d = \rho_{ver} \cdot S \tag{2}$$

The dispersion indicator (κ_d , m⁻¹) has dimension, return to the particle size that characterizes crushing (grinding) of a material. The role of the superficial phenomena in agglomeration processes ($E_s = \sigma \cdot S$) increases with dispersion growth. The results of the calculations of the dispersion indicator of various materials showed that the higher the material dispersion, the lower its bulk density and the higher the optimum humidity of formation (Il'ina, 2013).

Taking into account the results of the conducted researches and also the existing data on the agglomeration of various disperse systems we offered the classification of disperse materials according to the dispersion indicator on: low-disperse ($K_d < 2 \cdot 10^6$ m⁻¹), middle-disperse ($K_d = 2, \dots, 6.10^6$ m⁻¹), high-disperse ($K_d > 6.10^6$ m⁻¹), middle-disperse and high-disperse ($K_d > 6.10^6$ m⁻¹).

It should be noted that the dispersion indicator is applied to the lyophobic materials assessment which form according to PA. Reh binder's classification the thermodynamic unstable disperse systems. According to the offered indicator of dispersion the recommendations about the choice of the organization method of the agglomeration processes in disperse systems of various stability (Fig. 5) are developed.

The granules may be formed from materials with a dispersion indicator ($K_d = 2, \dots, 6.10^6$ m⁻¹) by the extrusion and pelletizing method at the humidity of 18-23%. The coefficient of the consolidation of these materials is from 2-6. During the granulation it is expedient to give the technological sheaf spraying on the material which is

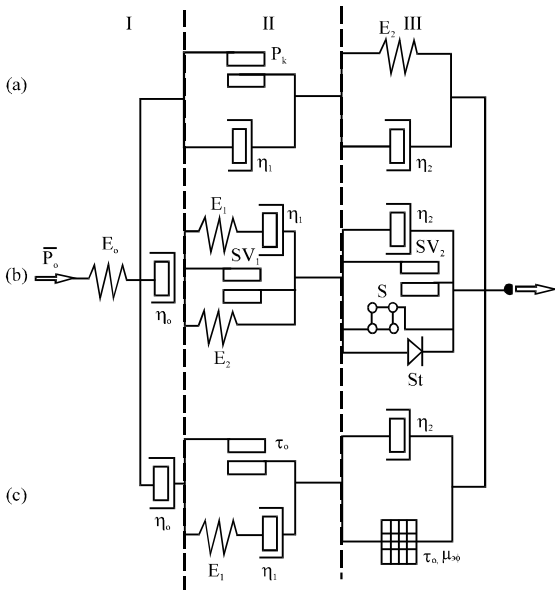

Fig. 4: Mechanical models of compaction processes of technogenic materials by various ways; a) extruding (viscoplastic formation); b) pelletizing (semi-dry formation); c) bricketing (semi-dry and dry forming)

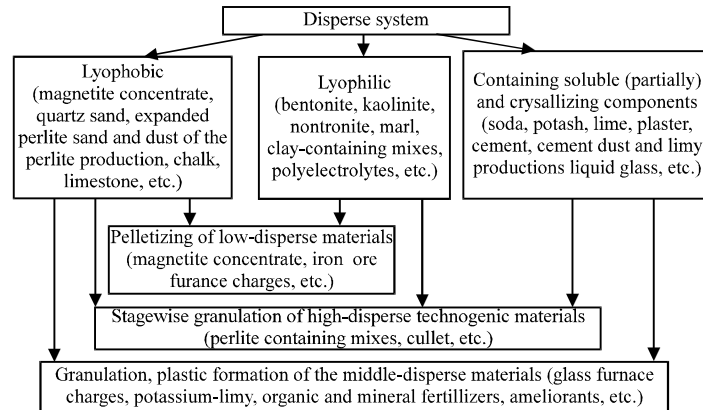

Fig. 5: Recommendations about the organization of the agglomeration processes of in disperse systems of various stability

poured in the granulator in the field of the gravitational and centrifugal forces. If according to the technological requirements the composition includes the soluble and crystallizing components for example in glass furnace charges, so at the stage of the mixture of the damp furnace charge there is a dissolution and crystallization of the components with the formation of coagulative, condensation and crystallizational structure of a crude granule as a result of its pelletizing (Il'ina, 2013).

Now the problem of utilization of the Technogenic Fibrous Materials (TFM) is particularly acute: waste of the woodworking enterprises, agricultural phytogenesis waste, pulp-and-paper waste, etc. A large number of this waste are stored occupying the big spaces and negatively influencing on the environment. The most rational decision is the application of the resource-saving technologies connected with secondary processing of TVM and application of the received materials in various branches.

For example one of the branches where the Pulp-And-Paper Waste (PAPW) can be used is the production of the crushed-stone and the mastic asphalt concrete (Smirnov, 2003). The application of the granulated stabilizing additives consisting of processed PAPW allows to increase significantly the coating life to achieve high durability and resistance to the mechanical influences and plastic deformations.

Nowadays, the stabilizing additives based on the cellulose which is a product of various ways of the vegetable raw materials processing have the greatest distribution. Thus, the cellulose is applied in the form of extrudable granules made of the fibrillated (crushed) fiber with their processing by the modifying structures or without them.

One of the technical solutions at the spill utilization made by the granules classification and also caught in the

aspiration system of the fine dust loss is the use of the devices for the pneumomechanical agglomeration of TFM in the air stream under the influence of the centrifugal forces caused by the change of the air movement direction (Il'ina and Emel' anov, 2013).

To receive the granules by the pneumomechanical way it is necessary to determine the terminal velocity of the particles. The terminal velocity of a spherical single particle in the unlimited environment can be calculated by the various formulas including the generalized method through Archimedes and Lyashchenko's criterion. Under the conditions of the air stream movement in the limited space the concentration of these particles in the stream influences on the particles.

The influence of the particles concentration on their resistance in a stream can be considered by means of various empirical dependences for example Todes's formulas equal to the volume concentration of particles in the stream $\epsilon_m > 0.01$ (Shilyaev and Shilyaev, 2003):

$$Re = \frac{Ar(1-\epsilon_m)^{4.75}}{18+0.61\sqrt{Ar(1-\epsilon_m)^{4.75}}} \quad (3)$$

The particles of the crushed newspaper and office paper which have density of 100 and 800 kg/m³ were taken for comparison. The calculations were made for various conditions and the schedule of the dependences of terminal velocity of various size of the particles and the density from the volume concentration (Fig. 6) was constructed.

It follows from Fig. 6 that the concentration increase of a firm phase has considerable impact on the terminal velocity. At the concentration about 0.05 m³/m³ the terminal velocity of a particle is about 15-18% lower than the terminal velocity in the unlimited space. At further

concentration increase this difference increases more. The insufficiently exact measurement of the firm phase concentration on the terminal velocity at the volume concentration higher than 0.04-0.05 m³/m³ leads to considerable mistakes. For this reason, the firm phase concentration which is about 0.04 m³/m³ can be the highest limit of the pneumotransport existence with low concentration. At this concentration, it is still possible to count the speed of a transporting stream proceeding from the terminal velocity of a single particle.

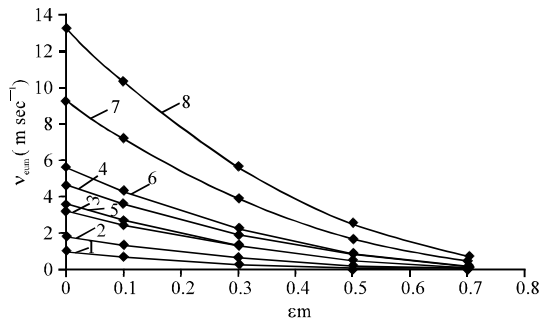

Fig. 6: Dependence of terminal velocity v_{terr} on volume concentration ϵ_m with various diameters d_e of newspaper particles ($\rho = 100 \text{ kg/m}^3$); 1) $d_e = 1 \text{ mm}$, 2) $d_e = 2 \text{ mm}$, 3) $d_e = 5 \text{ mm}$, 4) $d_e = 10 \text{ mm}$; for office paper particles ($\rho = 800 \text{ kg/m}^3$); 5) $d_e = 1 \text{ mm}$, 6) $d_e = 2 \text{ mm}$, 7) $d_e = 5 \text{ mm}$, 8) $d_e = 10 \text{ mm}$

It is also possible to note that the terminal velocity of the single crushed particles of the newspaper and office paper considerably differ from each other. At the values of volume concentration >0.5 the difference between speeds is leveled. It occurs because of the agglomerates formation in the air stream and also owing to the resistance increase of a large number of particles in the air stream. Therefore, this range is very interesting for the devices design of the pneumomechanical granulation of fibrous materials.

According to the results of the conducted complex researches we developed the patent protected designs of units and technological modules for the realization of agglomeration processes taking into account the specific features of technogenic fibrous materials (Sevostyanov *et al.*, 2013; Glagolev *et al.*, 2011; Il'ina *et al.*, 2010, Sevostyanov *et al.*, 2013) and solutions on the improvement of processes agglomeration are offered (Fig. 7).

As shown in Fig. 7 the complexity of decisions consists not only in constructive and technological improvement of devices and the selection of binding additives for the pelletizing granulation of the materials but it also includes the development of the actions for the environmental protection against dust emissions. The requirements to the components of binding solutions, their structures and superficial expense are developed to

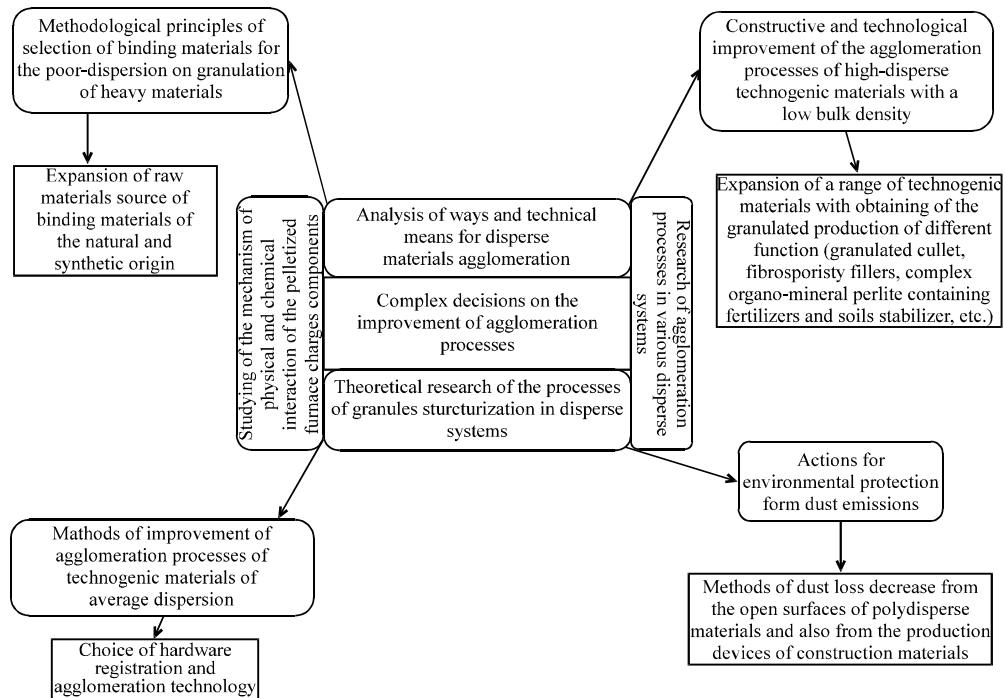

Fig. 7: Complex decisions on the improvement of agglomeration processes

prevent dust loss for the agglomeration of the surface coating of open disperse systems (Il'ina, 2010). The additives in the raw slimes promoting the particles agglomeration at the drying stage are offered for dust loss decrease from the clinker furnace (Il'ina, 2008).

DISCUSSION

The offered methodology of carrying out researches and results of complex researches allowed to develop the directions of improvement of agglomeration processes of technogenic materials for the purpose of their utilization and environmental protection against harmful effects of industrial wastes.

CONCLUSION

On the basis of theoretical and pilot studies of the structurization process in disperse systems the mechanical models of processes of compaction of disperse materials are developed in various ways: extruding, pelletizing and briquetting. The classification of materials by the coefficient of dispersion considering the nature of a material and a way of its preparation is offered. The recommendations about the organization of agglomeration processes which are realized in technological modules and complexes of multipurpose action for technogenic materials processing and compacted production obtaining are developed.

ACKNOWLEDGEMENTS

The research is performed under support of the Ministry of Education and Science of the Russian Federation within the program of strategic development of BSTU named after V. G. Shukhov for 2012-2016 (2011/PR-146). Researchers thank the colleagues who have rendered assistance at carrying out the real researches.

REFERENCES

Evtushenko, E.I., O.K. Sysa, I.Y. Moreva, V.I. Bedina, A.I. Bredikhina and A.A. Skiba, 2009. Improvement of raw materials preparation by means of activation processes in ceramics technology. *Glass Ceramics*, 66: 14-16.

Glagolev, S.N., W.S. Sevostyanov, T.N. Il'ina and V.I. Uralsrii, 2011. Production modules for combined reprocessing of technogenic materials. *Chem. Pet. Eng.*, 9: 556-560.

Gridchin, A.M., V.S. Sevostyanov, N.N. Dubinin and M.V. Sevostyanov, 2006. Energy saving equipment and technology for complex processing of natural and technogenic materials. *World Glass*, 6: 43-48.

Gridchin, A.M., V.S. Sevostyanov, V.S. Lesovik, S.N. Glagolev, M.V. Sevostyanov, I.M. Funikov and A.V. Uralsky, 2007. Technological complexes for production of the air-entrained fillers from technogenic materials. *News Higher Educ. Instit. Construction*, 7: 22-28.

Il'ina, T.N. and E.I. Gibelev, 2009. Granulation in technology for utilization of industrial waste materials. *Chem. Pet. Eng.*, 45: 495-499.

Il'ina, T.N., 2008. Reduction in dust carry-over from a rotary cement kiln. *Chem. Pet. Eng.*, 44: 589-596.

Il'ina, T.N., 2009a. Agglomeration Processes in Technologies of Processing of Disperse Materials: Monograph. BSTU Publishing House, USA., Pages: 229.

Il'ina, T.N., 2009b. Structural and mechanical properties of pelletized fine materials. *Chem. Pet. Eng.*, 45: 115-119.

Il'ina, T.N., 2010. Methods of polydispersed material surface layer agglomeration. *Chem. Pet. Eng.*, 46: 89-95.

Il'ina, T.N., 2013. Classification of fine materials and recommendations for sintering. *Chem. Pet. Eng.*, 49: 229-232.

Il'ina, T.N., M.V. Sevostyanov and E.A. Shkarpetkin, 2010. Constructive and technological improvement of units for the granulation of powdery materials. *Bull. BSTU Named V. G. Shuhov*, 2: 100-102.

Makarenkov, D.A., V.I. Nazarov, A.M. Gonopolsky and Y.A. Trefilova, 2013. Features of the choice of the granulating equipment of multicomponent polydisperse furnace charges with secondary material resources on the basis of the system analysis. *MGOU Bull.*, 1: 49-64.

Min'ko, N.I., E.A. Laz'ko and E.A. Doroganov, 2008. Effect of finely disperse cullet on glass batch briquetting. *Glass Ceramics*, 65: 305-309.

Sevost'yanov, W.S., T.N. Il'ina, M.V. Sevost'yanov and D.À. Emel'anov, 2014. Processes of granular charges pre-compaction. *Adv. Nat. Applied Sci.*, 8: 301-304.

Sevost'yanov, M.V., T.N. Il'ina, V.S. Sevost'yanov and V.A. Uvarov, 2013. Mechanical compaction process models of man-made materials and their instrumentation software. *World Applied Sci. J.*, 25: 1770-1775.

Shilyaev, M.I. and A.M. Shilyaev, 2003. Aerodynamics and Heatmass Exchange of Gas-Disperse Streams: Studies. Publishing House Tomsk, Tomsk, Pages: 272.

Zagorodnyuk, L.H., V.S. Lesovik and L.D. Shakhova, 2010. Technogenic Products in Production of Dry Construction Mixes: Monograph. BSTU Publishing House, USA., Pages: 93.