

Monitoring of FBG as Elements of Subscriber Access Nodes in TWDM-PON

Oleg G. Morozov and Mustafa H. Ali

Kazan National Research Technical University. A.N Tupolev-KAI, Kazan, Russia

Abstract: Many efficient monitoring methods were proposed and applicability was demonstrated. One of the proposed methods uses passive components at the subscriber side (a simple FBG) for reflects the monitoring signal that generated in the OLT. The OLT apply simple signal processing steps on the OFDR trace to deduce the Bragg wavelength shift of each FBG in the network. Then calculate the shifting amount that give us the temperature at any place in the network. This functionality provides the monitoring system with the capability of foreseeing the evolution of temperature in the network terminals before some unexpected environmental conditions (high temperature, freezing due to an open remote terminal port. This system can be used in our TWDM-PON to monitor the ODN&ONU efficiently. In this thesis, a study for a Comparison between AWG methods with wide band source and FBG methods with two frequency source.

Key words: Fiber Bragg Grating (FBG), Array Waveguide Grating(AWG), ODN, OLT, PON

INTRODUCTION

In the PON (Passive Optical Network), the ODN is pure passive and the electrically power are available only in the OLT and ONU and some time in RN (Remount Node) using LP-PON (long reach PON) (Wong, 2014) multimedia applications require a lot of bandwidth each residential home typically requires 20-100 Mbps peak bandwidth (Cheng, 2015) for example each HDTV required approximately 20 Mbps for per channel. As the multimedia applications continue to proliferate and to meet all these requirements, FSAN group and ITU-T have chosen TWDM-PON as the solution for future broadband optical access because it transceivers provide to each one utilizes pair of wavelengths and the transceivers are multiplexed using Arrayed Waveguide Grating (AWG) as multiplexer/de-multiplexer, then the multiplexed data signal is amplified and sent over 40 Km aggregated capacity in a single optical distribution network and sustainable 500 Mbps to 1 Gbps bandwidth for each ONU. Large splitting ratio with 64-256 ONUs per feeder fiber and long reach over 40 km are highly desired (Cheng, 2015) TWDM-PON can coexist with legacy PON systems, so the upgrade from GPON/EPON or 10G PON to TWDM PON will be very simple without any service interruption. The number of FTTH/B (Building) subscribers is increasing rapidly throughout the world. We can no longer ignore the Operation, Administration and Maintenance (OAM) costs in addition to the

construction cost. Fiber monitoring and fiber fault location are required as fundamental functions for optical fiber cable network maintenance (Cheng, 2015) instrument for Monitoring PON has a different types most known OTDR (Optical Time Domain Reflectometry) and OFDR (Optical Frequency Domain Reflectometry).

Basically principle for temperature measuring by means of FBG: Several physical layer monitoring solutions based on Optical Time Domain Reflectometry (OTDR) have been proposed in the literature. However, implementation of OTDRs into tree-structured PONs brings several challenges which are: the lack of dynamic range to monitor the infrastructure after the splitter a long measurement time due to averaging necessary to obtain an OTDR trace repetition of the measurement on large number of ONTs The reflection dead-zone that makes it impossible to distinguish the monitoring reflection peaks from two nearby located ONTs.

Monitoring solutions based on Optical Frequency Domain Reflectometer (OFDR) recently appeared in the literature as an alternative approach. These solutions require however either a very coherent laser source to reach an adequate measurement range (a few tens of kilometers) or some complicated modulation schemes superimposed on the downstream data signal. A very recent monitoring strategy based on interferometric devices placed at the ONTs relaxes the requirement on the

line width of the light source. However, this solution detects only the breaks (or disconnects) in the network (Yuksel *et al.*, 2010).

We describe a new monitoring method for PONs using an OFDR at the OLT and interferometer units (IF-unit) at the ONTs/ONUs. Each IF-unit includes a uniform Fiber Bragg Grating (FBG) and creates a beat term (a peak) on the OFDR trace which is used to check the integrity of the corresponding branch. Analyzing the beat terms of all branches allows an easy distinction of the faulty branch after the splitter. In addition to the easy determination of the faulty branch, the system directly measures the temperature in the network terminals such as ONU/ONT, fiber distribution hub or network access terminals. Temperature measurement is realized by using the temperature sensitivity of the FBG's spectrum inside the IF-units.

We apply simple signal processing steps on the OFDR trace to deduce the Bragg wavelength shift of each FBG located in each IF-unit. This information in turn gives the temperature evolution of interferometer device's position. To the best of our knowledge, this is the first time that a surveillance system provides information about the physical parameters of the network terminals in a fully optical manner. This functionality provides the monitoring system with the capability of foreseeing the evolution of temperature in the network terminals before some unexpected environmental conditions (high temperature, freezing due to an open remote terminal port...) create severe consequences (Yuksel *et al.*, 2010). The proposed solution is applicable for any kind of PON architecture (tree, ring...) and multiplexing scheme (TDM, WDM). Moreover, measurement time is considerably short (a few seconds) compared to OTDR methods.

MATERIALS AND METHODS

Fiber Bragg Grating (FBG): This modified fiber serves as a wavelength selective mirror: light travelling down the fiber is partially reflected at each of the tiny index variations but these reflections interfere destructively at most wavelengths and the light continues to propagate down the fiber uninterrupted (Cheng, 2015). However, at one particular narrow range of wavelengths, constructive interference occurs and light is returned down the fiber. Maximum reflectivity occurs at the so-called Bragg wavelength λ_B , given by:

$$\lambda_B = 2n_{eff} \quad (1)$$

Where:

n_{eff} = The effective refractive index of the mode propagating in the fiber

λ_B = The FBG period

Method of experiment with AWG: In order to simulate temperature shift we have to shift central frequency of FBG 10 with the step as shown in Fig. 1-4. To make conclusion about possibility of these method application FBG vs. AWG.

Structure of AWG with wide band source and FBG Calculate the reading and draw a chart of wavelength vs. modulation coefficient: We will transform the previous measurement to a chart according to this equation shown in Fig. 5:

$$A_{max} = A1 + A2 \quad (2)$$

$$A_{min} = A1 - A2 \quad (3)$$

$$\mu = 2(A_{max} - A_{min}) / 2(A_{max} + A_{min});$$

A1 = First sample from the left;
A2 = Second sample from the left

$$(4)$$

Generating two frequencies as a narrow band using CW laser

Component of the scheme

CW laser: In the CW case, the average output Power is a parameter that you specify. Laser phase noise is modeled using the probability density function.

Single drive mach-zehnder modulator measured

Technical background: In this model, you can specify the dependence of the measured absorption and phase on applied voltage for a Mach-Zehnder modulator. You can use the default characteristics curves or choose to load from Filename.

Sine waves: Sine waves are perhaps the most recognizable wave shape. Most AC power sources produce sine waves. Household wall outlets deliver power in the form of sine waves. And the sine wave is almost always used in elementary classroom demonstrations of electrical and electronic principles. The sine wave is the result of a basic mathematical function graphing a sine curve through 360° will produce a definitive sine wave image.

Method of experiment of FBG with two frequencies:

Formation with two component radiation Adjacent central frequency to the central frequency of the FBG In order to simulate temperature shift we have to shift central frequency of FBG 10 point left and 10 point right with the step as shown in figure below To make conclusion about possibility of these method application.

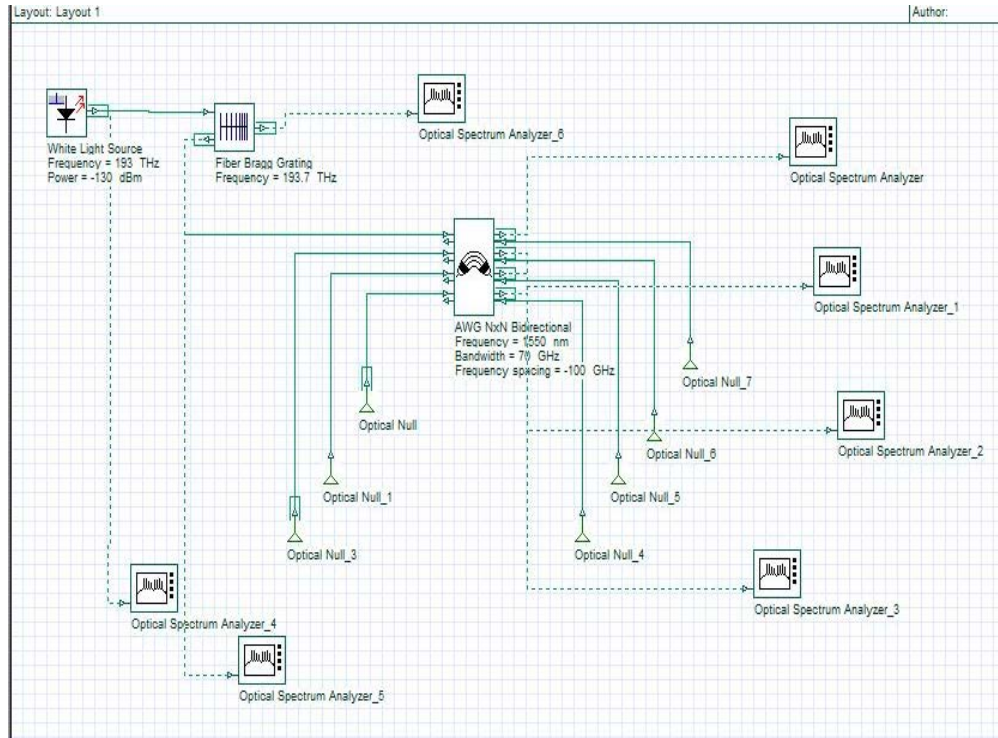

Fig. 1: Scheme of AWG with wide band source and FBG

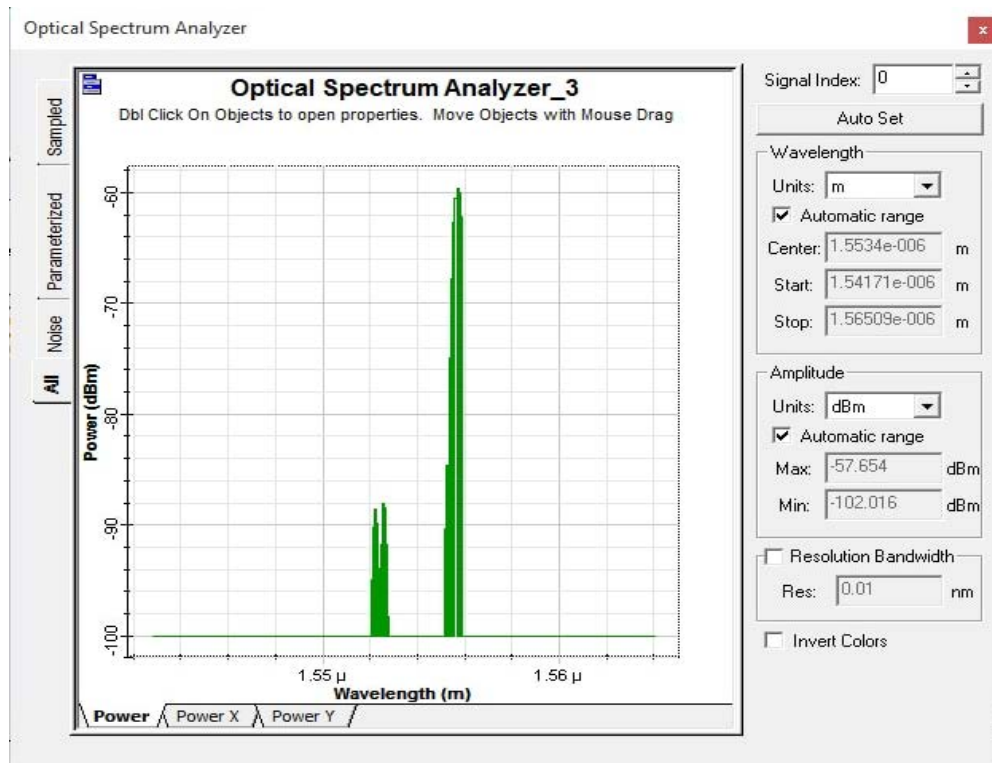

Fig. 2: Reading of the OSA No3 with 192.7 THz

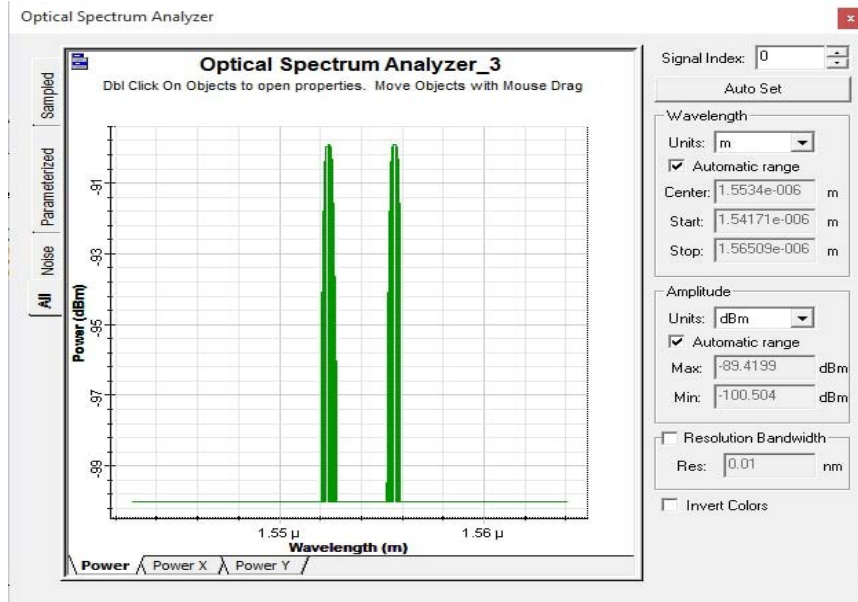

Fig. 3: Reading of the OSA No3 with 193.1 Thz

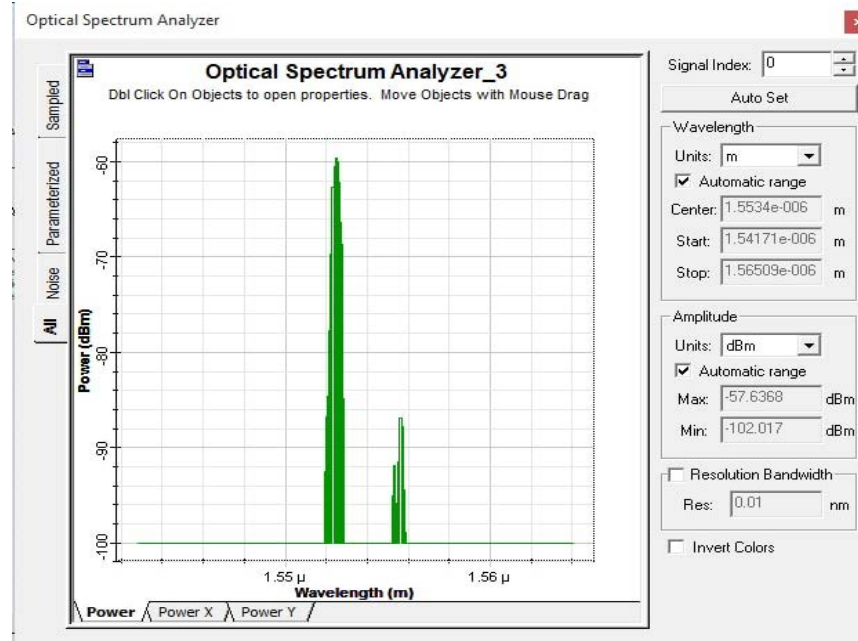

Fig. 4: Reading of the OSA No3 with 193.7 Thz

Generating two frequency with equal amplitude: In the first scheme We generate a two sample for monitoring then we change the value of the bias voltage 1&2 in the modulator as showing (Fig. 6).

Simulates a Mach-Zehnder modulator with single drive modulation using measured paramete

(Fig. 7). Then from the perverse change we will get two equal sample as shown in Fig. 8.

Structure of FBG with two frequency source: Now, we used the two generated sample in Fig. 8 and put FBG in the block Fig. 6 to become as shown blow and change

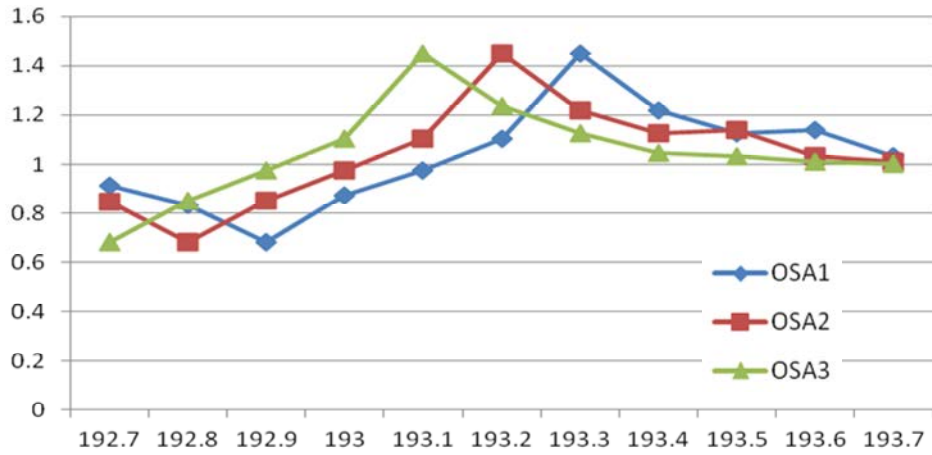

Fig. 5: Wavelength vs. modulation coefficient, chart for the privies reading according to the equation

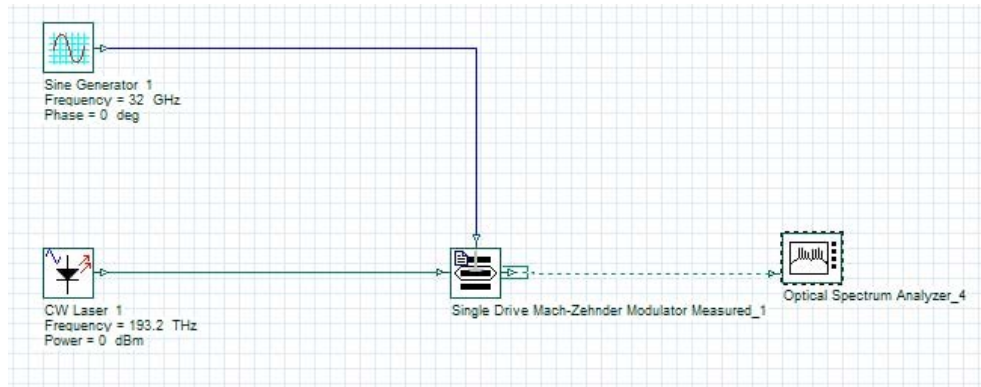

Fig. 6: Scheme of generating the two samples for monitoring

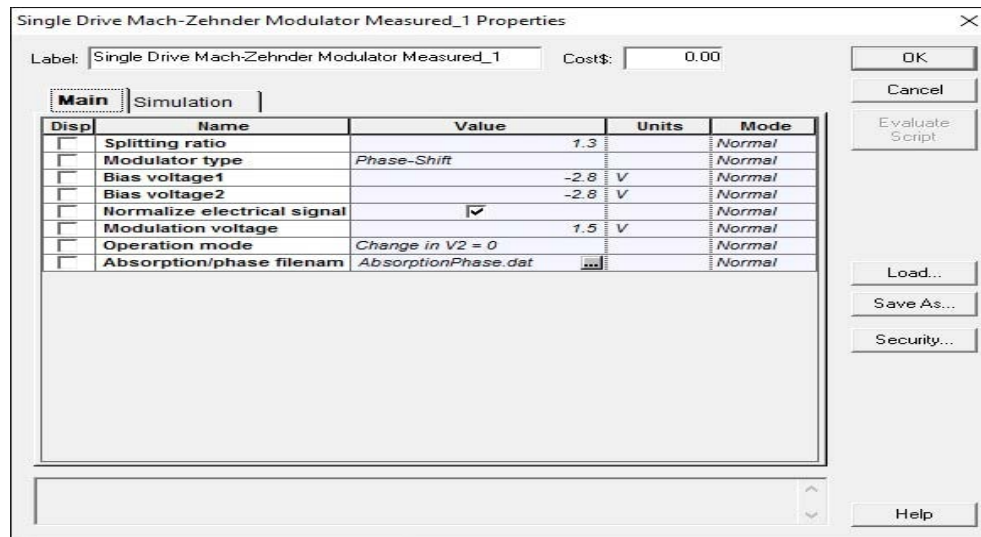

Fig. 7: Amount of bias voltage 1, 2 that required to great a perfect monitoring signal

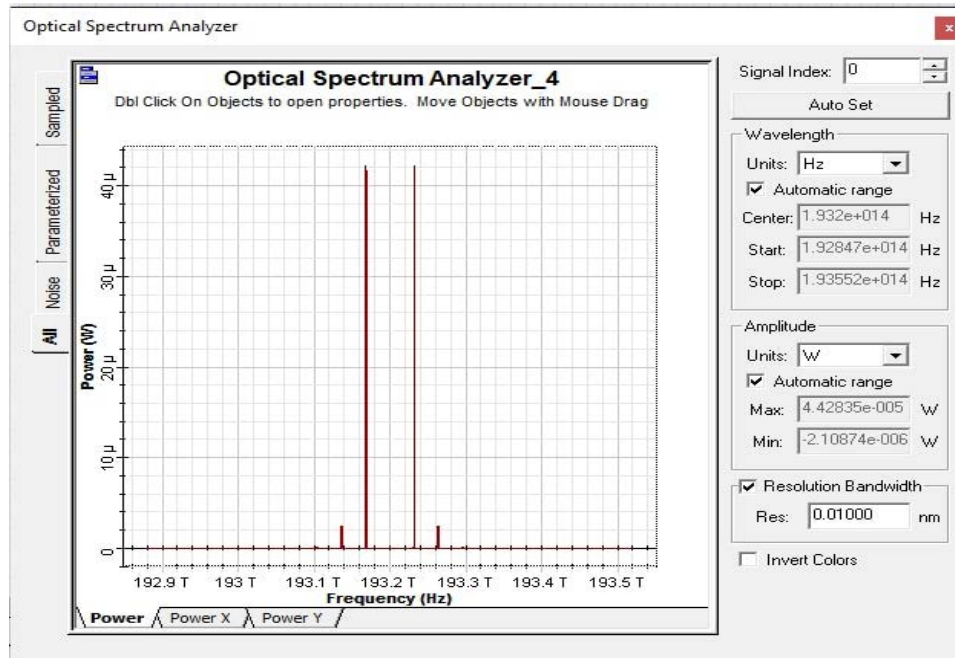

Fig. 8: Two sample that generated from the scheme (Fig. 6)

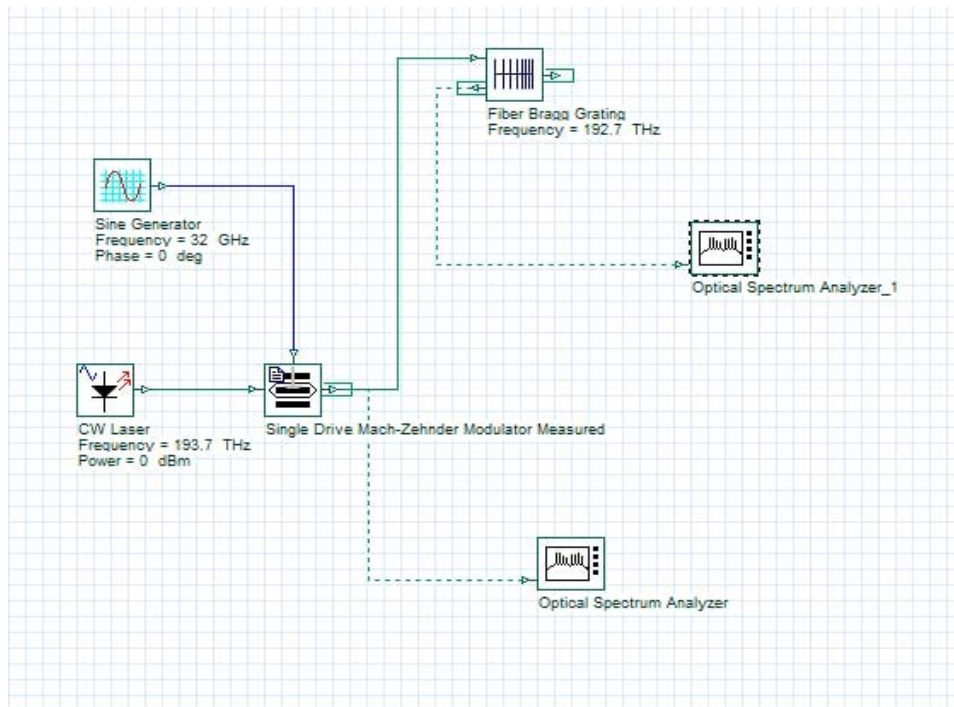

Fig. 9: Scheme of generating two sample for monitoring using FBG

this central 10 step frequency from 192.7-193.7THz with every change in the FBG we will notice some change in the two sample the 10 step of FBG

changing is simulate the temperature change in the ONU or ODN (Fig. 9-12). We can monitor using FBG instate of AWG.

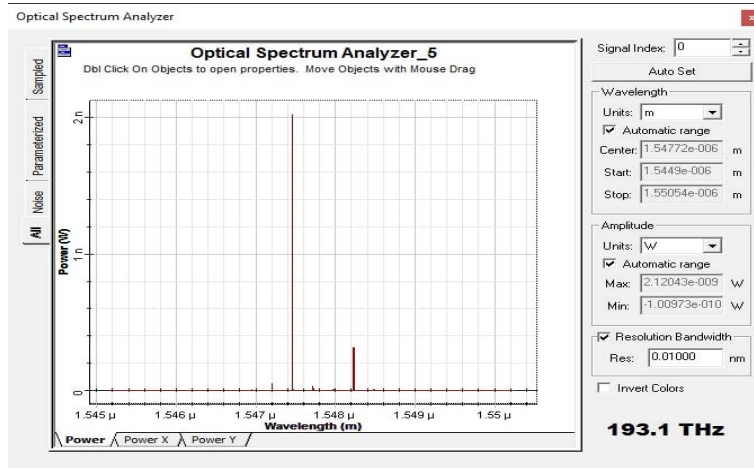

Fig. 10: Reading of the OSA No6 with 193.1 THz

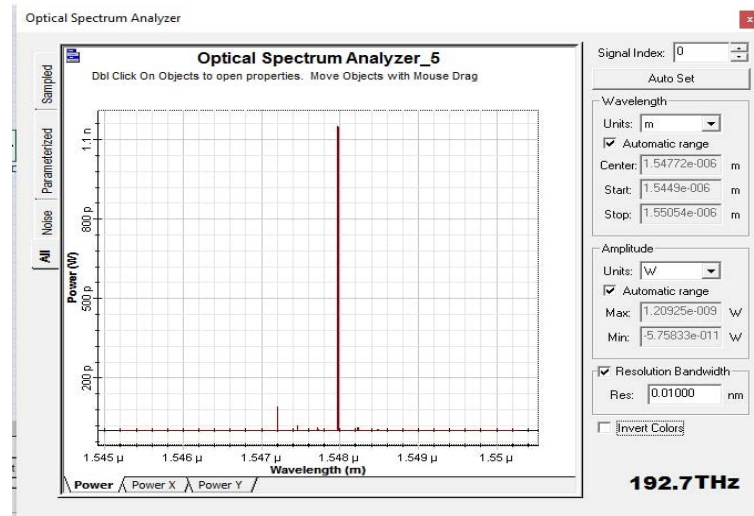

Fig. 11: Reading of the OSA No6 with 192.7 Thz

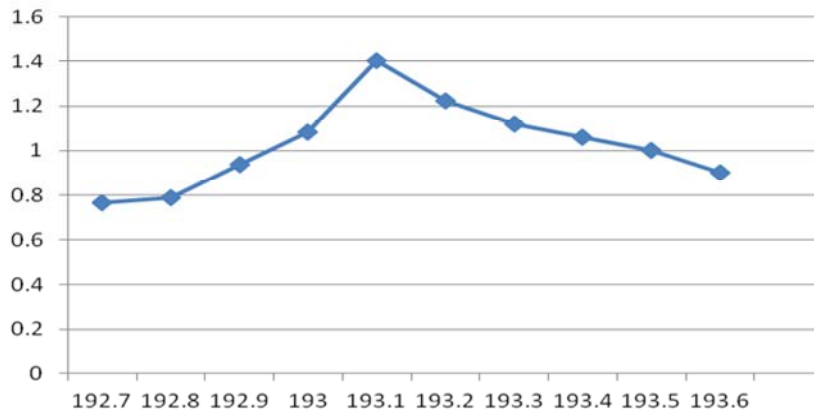

Fig. 12: Wavelength vs. Modulation coefficient, chart for the reading of Fig. 9 and calculated according to Eq. 4

RESULTS AND DISCUSSION

Here, we show a comparison between AWG methods with wide band source and FBG methods with two frequency source. The chart used in my work represents the change of the temperature represented by changing the central frequency of the FBG (wavelength) vs. modulation coefficient so we can simulate the temperature changed in the ONU and ODN, we can measure the temperature of the ONU & ODN OLT by means of AWG sensor with a wide band source but Measuring ONU temperature ODN OLT by means of two frequency source and FBG is more, simpler, cheaper, more accuracy and remain band we can used for the data instate of monitoring signal because after all we used only two frequency is much smaller than the wide band.

Why the reading in the modulation coefficient 1.4 bigger than 1 the modulation coefficient cannot be bigger than 1, 1.4 mean that we have inter modulation or over modulation "interference modulation". But it is right because we don't have only amplitude modulation we have also phase modulation and energy of phase modulation is add. So, it became 1.4.

CONCLUSION

We can measure the temperature of the ONU, ODN and OLT by means of AWG sensor with a wide band source but measuring ONU temperature ODN, OLT by means of two frequency source with FBG is the same as we will prove it. Also, it is more Simpler, cheaper, accuracy and the remain band in the FBG method we can used for the data instate of monitoring signal.

REFERENCES

- Cheng, N., 2015. Flexible TWDM PON with WDM overlay for converged services. *Opt. Fiber Technol.*, 26: 21-30.
- Wong, E., 2014. Survivable architectures for time and wavelength division multiplexed passive optical networks. *Optics Commun.*, 325: 152-159.
- Yuksel, K., M. Wuilpart, V. Moeyaert and P. Megret, 2010. Original monitoring technique for passive optical networks combining fiber Bragg gratings and wavelength swept light source. *Proceedings of the 2010 12th International Conference on Transparent Optical Networks*, June 27- July 1, 2012, IEEE, Munich, Germany, ISBN:978-1-4244-7799-9, pp: 1-5.