



## Adaptive Control Scheme for Wind Turbine Generator

Mansour Farhan, Ismaiel Sharhan and Mohammed Kasim Gasim

*Department of Engineering College, Electrical Engineering, Wasit University, Kut, Iran*

**Key words:** WT, NARMA, PID, ANFIS, controller, simulated

**Abstract:** This study developed the mathematical model applied the artificial intelligence techniques of to simulated a wind turbine control system utilization PID, ANFIS and NARMA controllers. Wind power plays an important function in production of electric power and effected voltage and frequency stability. Rotary of wind turbines transmit vary types of loads and pneumatic loads which cause rotor blades to deteriorate to the turbine using MATLAB/Simulink to control of pitch angle to maintain turbine blades. Finding: The result of artificial intelligence techniques show response of time and time stability of three methods showed that the ANFIS controller is the best compared to other methods. The PID produces a lower time response but it has oscillations with peak exceeding (0.08) and rise time (5 sec).When you apply NARMA Controller, the result is less rise time (0 sec), the stability time exceeds (6 sec) and exceeds the maximum results using ANFIS whose design is able to effectively stop the steady-state error to zero and the rapid rise time systems (0) and the time stabilizes (5.8 sec) from the analysis, it is concluded that the ANFIS control gives a relatively quick response to the input. This method to control of pitch angle is a better technique of the system control.

### Corresponding Author:

Mansour Farhan

*Department of Engineering College, Electrical Engineering, Wasit University Kut, Iran*

Page No.: 72-84

Volume: 15, Issue 2, 2020

ISSN: 1815-932x

Research Journal of Applied Sciences

Copy Right: Medwell Publications

## INTRODUCTION

For the previous few periods, the demands of energy have been increasing gradually, electrical power and environmental issues especially and this has become a challenging problem for the world. Besides, pollution is gradually increasing parallel to energy demand while traditional energy sources such as fossil fuels are rapidly depleting. This has led to the finding of several alternatives for renewable energies to generate Electric current<sup>[1]</sup>. Clean energy is known be capable of generate from different environmental source such as solar

radiation, wind movement, water flow and biological waste. However, such energy is about low cost and handy with no clear environmental pollutants. The power generated by wind being soundly alternative of those produced by classic fuels and also has no impacts on global warming. Furthermore, such energy is produce by transferring kinetic power to electric form by using well designed turbines<sup>[2]</sup>.

**Principal of Wind Energy Conversion System (WECS) WECS consists of the following<sup>[3]</sup>**

**Mechanical system:** This part consists of the rotor hub,

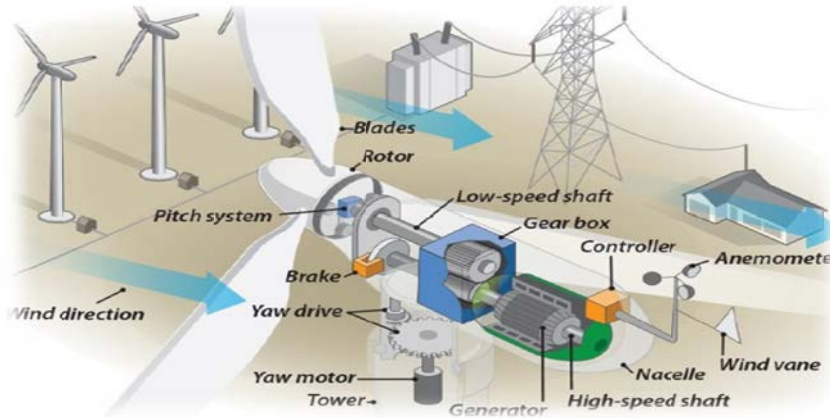

Fig. 1: Component of a wind turbine

rotor blades, main shaft, rotor bearings, pitch drives, mechanical brake, gearbox, yaw drives, wind measurement element, nacelle, tower, foundation, heat exchange system and ladder.

**Electrical system:** The components of electrical system are wind generator, power electric generating converters, grid filters, electric transformers (step-up), cables and switchgear.

**Control system:** This system is responsible of controlling both electrical system and mechanical system. The wind energy captured turbine enhancement using two controls as pitch and stall controls. The first check power output of turbine utilize electronic controller. When wind speed is high of operational limit because send signal to the blade pitch mechanism. Turbine with type of mechanism control is known a pitch controlled WT<sup>[4]</sup> that show compound of WT in Fig. 1.

Many researcher are study control of wind turbine such as Qi and Meng<sup>[5]</sup>. Apply PID to control generator speed and blade angle. It gives a result that can make the generator run at maximum power. Civelek *et al.*<sup>[6]</sup>: Use P, I and D to adjust the rotational speed and using IGA algorithm for the PID parameter to modify the blade controller settings Suganthi *et al.*<sup>[7]</sup>: A fuzzy logical control application to enhance control of wind turbines. showed The results that obscure models have been widely used in recent years for site evaluation Cost *et al.*<sup>[8]</sup> Apply fuzzy logic control to pitch angle, to enhance pitch control for grid-connect WT by increasing the penetration of wind energy. Very short-term wind control data is incorporated through the adoption of new real-time forecasting techniques.

The main purposes of this study is applied intelligent controller (PID, ANN, ANFIS) of pitch angle and Comparison between them of time specifications.

## MATERIALS AND METHODS

**Wind turbine aerodynamic model:** Wind turbines generate electrical energy by extracting wind energy to trigger an electric generator. Turbine blades extract kinetic energy from the wind, creating a lift force and using rotary force. Inside the nest, the blades rotate the WT column, then activate the rotation force. The rotary blades raise the rotational speed to an appropriate speed for the generator. Then, the magnetic fields of the generator produce electrical energy from the rotary energy. The power generated to feed the transformer, in order to raise the generator voltage from approximately 700 V to the appropriate value of the power collection system is normally 33 kV<sup>[9]</sup> aerodynamic model of WT optimizes the withdrawal of power through the rotor, provide the mechanical torque by affect flow air at blades.

The speed of wind turbine is measured as average value occurrence speed on the blades swept area. The goals are to evaluate low speed axis average torque 10 Wind velocity feeding to WT as a parameter speed with value time and adjust pitch angle ( $\beta$ ) at 0 to get maximum coefficient power ( $C_p$ ). The sweep area of blade take out the kinetic energy from the wind according to (Eq. 1) and generate the moving air power ( $P_{air}$ ) according to Eq. 5<sup>[10]</sup>:

$$E = 1/2mv^2 \quad (1)$$

Where,  $m = \rho Av$  and  $\rho$  is density of air particles (nearly  $1.225 \text{ kg / m}^3$ ) and the blades swept as:

$$A = \pi R^2 \quad (2)$$

The moving air power is equal to:

$$P_{air} = dE / dt \quad (3)$$

$$= 1/2 \rho v^3 \quad (4)$$

$$= 1/2 \rho \pi R^2 v^3 \quad (5)$$

Equation 5. The wind power is highly depending on wind speed therefore comparative power to the cube wind speed. Pair indicates energy which obtainable in wind although, energy essentially motivate to rotor of the wind turbine ( $P_{wind\ turbine}$ ) is decreased by according to Eq. 6 and 7:

$$C_p = P_{wind\ turbine} / P_{air} \quad (6)$$

$$P_{wind\ turbine} = 1/2 \rho \pi R^2 v^3 * C_p \quad (7)$$

Where  $C_p$ : wind power coefficient, optimal rate coefficient wind power is 59.3% but experimental is approximation (0.25-0.45) rotor WT. The power and torque coefficient correspond analytical expression connected to ratio of tip speed ( $\lambda$ ) and pitch angle ( $\beta$ ). The frequently expression applied and improved to various WTs are given by Eq. 8.

$$(\lambda, \beta) = c_1 (c_2 / \lambda_1 - c_3 \beta - c_4) \exp -(C_5 / \lambda_1) + c_6 \lambda \quad (8)$$

Where  $c_1-6$  are equal to 0.517, 116, 0.4, 5, 21 and 0.0068 respectively for HAWT with a variable speed of wind 8. And ( $\lambda_i$ ) is given from the formula:

$$\lambda_i = \frac{1}{\lambda + 0.08\beta - \frac{0.035}{\beta^3 + 1}} \quad (9)$$

The tip speed ratio is calculated by the following equation

$$\lambda = \omega R / v \quad (10)$$

$C_p$  and  $\lambda$  dimensionless and apply to essential the exploit of rotor of WT at different sizes. Maximum  $C_p$  is attain just at a exclusive single tip speed ratio and for constant rotating speed of WT, it happens at a single wind speed. Later, one reason to operate WT at variable rotational speed to operate at maximum  $C_p$  over a different wind speeds<sup>[9]</sup>.

$C_p$  which depends on geothermal parameters and manufacturer, naturally  $C_p$  is introduced being associated with two limit ratio of ( $\lambda$ ) and ( $\beta$ )<sup>[11]</sup>.

Figure 2 shows a relationship of  $C_p$  ( $\lambda$ ,) at many number of pitch angles. It represent so as to, every pitch angle and of tip speed ratio it maximum value for example, gets the maximum at  $\beta = 0^\circ$ .

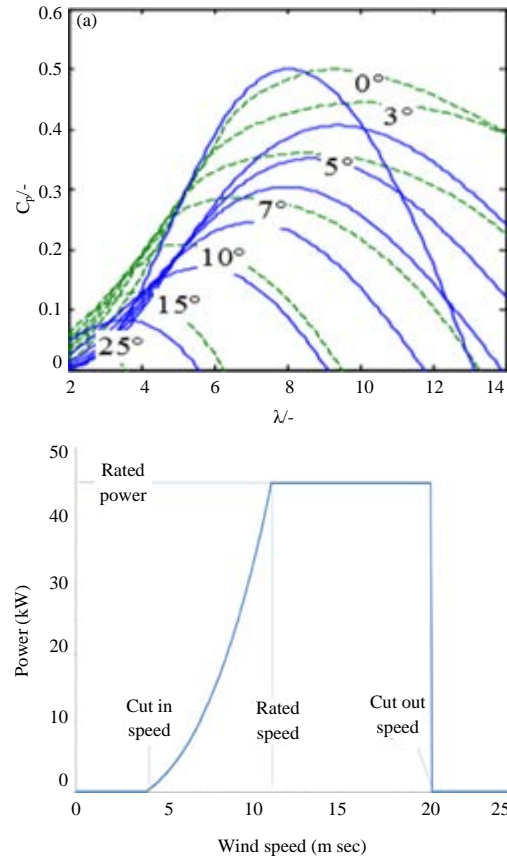

Fig. 2: The coefficient of power  $C_p$  ( $\lambda$ ,  $\beta$ ) and curve of WT power

Therefore, so as to cutting as possible as maximum energy from the wind. It's essential to situate  $\lambda$  and  $\beta$  to obtain optimal  $C_p$ <sup>[12]</sup>. The energy of wind turbine is defined at different speeds of the wind as expected by the energy curve shown in Fig. 2. The resulting electric power is displayed in a stable state of wind speed at elevation of axis and measure the application of the average information for 20 min 9. Initial spot of this curve illustrated the cut-in speed that smallest wind speed cause the machine deliver practical power. Next point is rating wind speed which energy rated is get (best output power of electrical generator). Finally point is Cut-out wind speed which is higher speed of WT that allow to transmit power<sup>[9]</sup>. The rotor of WT produce a torque according the formula :

$$T_w = P_{wind\ turbine} / \omega \quad (11)$$

**Control of pitch angle:** The pitch blade show the angle attack blades in rotor that shifted “to or out” of wind to control of power output<sup>[13]</sup>. The main function of control system blade to maintain the rotor speed within perimeter

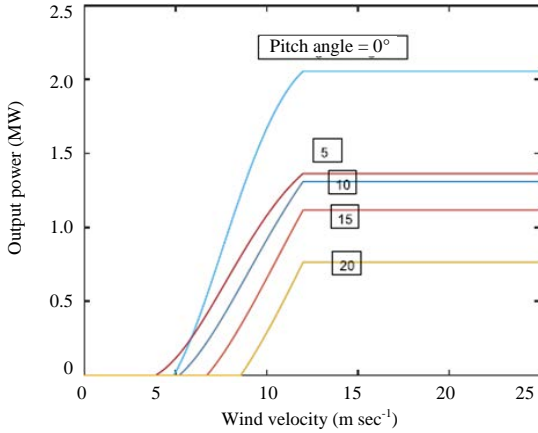

Fig. 3: Effect of the pitch angle on the output power

of operating by controlling of pitch angle to be different according to wind speed. The Eq. 12 demonstrate the mechanical power mechanical depend on wind speed “v” and the pitch angle “B”.

$$P_R = C_p(\lambda(v), \varphi) P = C_p(\lambda(v), \varphi) 1/2 A \rho v^3 = P_R(v, \varphi) \quad (12)$$

Figure 3 illustrate output power vary with incoming speed of wind. The maximum output appeared in zero pitch angle, the vary of pitch angle cause vary of output power. For this cause must be control of pitch angle for maintain of optimal performance of WT.

**Model pitch actuator:** The pitch actuator is employ of blade rotate along longitudinal axis. The dynamic model of actuator illustrate performance with pitch demand,  $\beta_d$  as of pitch controller and measurement value of pitch angle<sup>[14]</sup>. The vary of pitch angle in yjjs formula:

$$d_\beta / dt = (\beta_d - \beta) / T_\beta \quad (13)$$

$$T_\beta \cdot d_\beta / dt = (\beta_d - \beta) \quad (14)$$

$$T_\beta \cdot d_\beta / dt + \beta = \beta_d \quad (15)$$

$$\beta / \beta_d = 1 / (sT_\beta + 1) \quad (16)$$

The time constant of pitch actuator, TP calculate from initial variable of WT14 that illustrate in Table 1).

$$T_\beta = (\beta_d - \beta) / d_\beta / dt = 0.3 / 0.6 = 0.5 \quad (17)$$

$$\beta / \beta_d = 1 / (0.5s + 1) \quad (18)$$

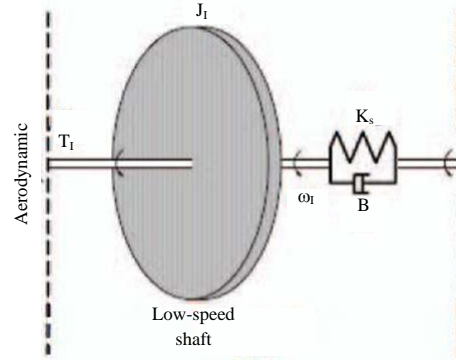

Fig. 4: Mechanical model of drive trail

Table 1: Parameters of wind turbine

Variables	Values
Rated generator power $P_e$	1000 KW
Rated generator speed, $W_e$	1500 rpm
Rayted turning speed of rator, $W_i$	20 rpm
Wind turbine blade Radius, R	35 m
Reference pitch angle, $\beta_d$	0-90°
Rate of change of pitch angle	0.6° sec
Control accuracy of pitch angle	0.3°
Damoing coefficient, B	2 Nm/rad/sec
river train incritin, $J_s$	0.72N.m <sup>2</sup>

Table 2: Mechanical model parameters of drive train

Parameters	Description	Parameters	Description
$J_T$	Wind turbine inertia [kg.m <sup>2</sup> ]	$W_T$	Wind turbine shaft speed [rad/sec]
$J_G$	Generator inertia [kg.m <sup>2</sup> ]	$W_s$	Generator shaft speed [rad/sec]
$K_s$	Stiffness coefficient [N.m/rad]	$\theta_r$	Wind turbine shaft angle [rad]
B	Damper coefficient [N.m/rad/sec]	$\theta_g$	Gear ratio
$T_T$	Wind turbine torque [N.m]	$1:n_{gear}$	
$T_G$	Generator electro-mechanical trrque		

**Model of drive terrain:** Figure 4 illustrate the model of drive terrain. The factors taken whereas modeling the drive train explain in Table 2. The drive-train dynamics described by formula:

$$J_T \cdot d / dt(w_T) = T_T - (K_s \delta \theta + B \delta w) \quad (19)$$

$$d / dt(\delta \theta) = \delta w \quad (20)$$

when applied second law of motion:

$$J dw / dt = T - Bw \quad (21)$$

by Laplace transform taking  $J \cdot W_s = T - BWJ \cdot W_s + BW = T$

$$W(Js + B) = T \quad (22)$$

$$WT = 1 / (Js + B) \quad (23)$$

Transfer function of Drive-train show in formula:

$$W / T = (1 / B) / ((J / B) \cdot s + 1) \quad (24)$$

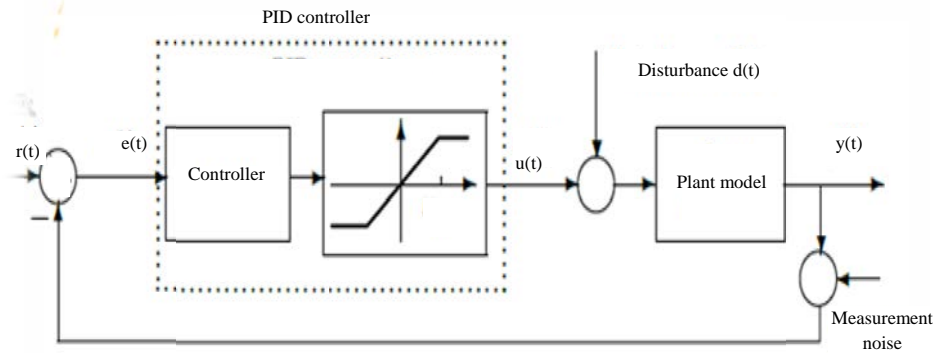

Fig. 5: PID control system

$$W/T=(1/2) / ((0.75/ 2).s + 1)= 0.5/(0.375s+1) \quad (25)$$

at last derived the mathematical model of WT<sup>[4]</sup>.

**Intelligent control techniques**

**PID controller:** The well known PID control strategy has been found to be a promising approach due to its little cost, simple to maintain also easy in control design. Basically the PID controller variables consist of three separate variables: proportionality (kp), integral (ki) and derivative values (kd). A fit setting of these variables will get better response of dynamic system, decrease overshoot, reduce the error of steady state and enhance system stability 15. The main control of PID that explain in Fig. 5. The change of set point, then compute the error between the real and set point. The error E(s) is employ to create the proportional, integral and derivative dealings with resulting signal weighted and summation to signal control be appropriate to explicit model. After then find signal of original output. This signal create to controller and the error is determined. Control signal is throw to plant. This procedure determination run until steady-state error approach to zero.

**Mathematical explanation of PID controller is:**

$$u(t) = k_p[e(t) + 1/T_i \int_0^t e(t)dt + T_d(de(t))/dt] \quad (26)$$

where u(t): The input signal and e(t): The error signal that illustrate in formula: e(t) = r(t)-y(t) and r(t) the reference input signal.

**Artificial Neural Networks Technique (ANNs):** “Artificial neural networks Technique (ANNs)” attempt to emulate their biological counterparts. McCulloch and Bates in 1943 proposed a model for neurons, a mathematical model representing the proposal of the formation and function of biological neural network; a block diagram of a simple mathematical model (function).

Includes three simple sets of rules “multiplication, combination and activation”. When inserted, synthetic neurons are weighed as each input value doubles with individual weight. In middle division of artificial neurons there is summarizes every the distributed inputs and bias. When artificial neurons outlet, the total input and pre-weighted bias bypass during the activation function transfer function)<sup>[15]</sup> that show in Fig. 6.

For network with (N) input nodes, (H) hidden nodes and (M) output nodes, the mapping from input vector (I1, ..., IN) to the output vector (O1, ..., OM) is given by:

$$O_q = g(\sum_{j=1}^H V_{jq}h_j), q=1, \dots, M \quad (27)$$

where, V<sub>jq</sub>: The weight from hidden node (j) to output node (q) and (g): The activation function. The value of hidden layer node h<sub>j</sub>, is given by:

$$h_j = \sigma(\sum_{i=1}^N w_{ij} + w_j), j=1, \dots, H \quad (28)$$

where, W<sub>ij</sub> the input weight from input node (i) to hidden node (j), W<sub>j</sub>: the weight threshold from input node that is constant value to hidden node j, I<sub>i</sub>. The value input node (i) and s: The activation function. A nonlinear activation function is employed in neurons of the hidden layer in order to achieve the nonlinear mapping ability.

**Hybrid adaptive neuro-fuzzy controller:** Neural-fuzzy model is concerned with deciding the samples of the numeric data is running system behavior. This type of modeling has two purpose: Primary, providing a model allows for monitoring and possibly predicts a way unknown system secondary producing a model for the best perception of non-linear system. in this case The model, on the rules is established; fuzzy logic has been used to contain set of rules represent “IF-THEN”. The capability to learn from feeding forward networks support

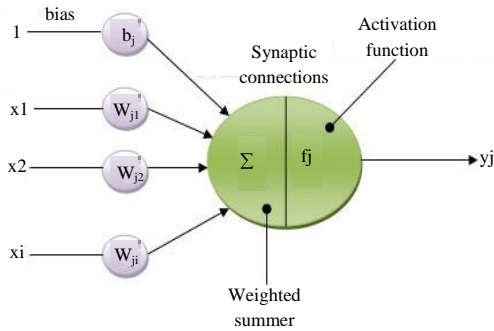

Fig. 6: Structure of neural network

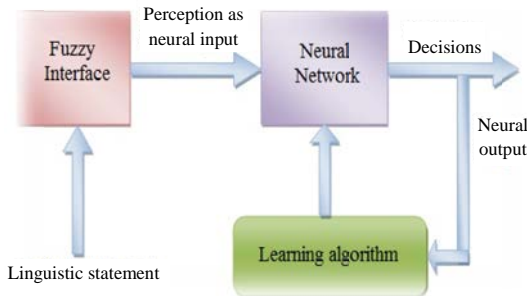

Fig. 7: General structure of neural fuzzy system

bleeding if model the architecture of the network, once properly, must to rules without losing information. Many have studied this idea accurately the authors began with start of the 1990's<sup>[16]</sup>. This hybrid technique is known as a neurofuzzy technique. Two models of mysterious neural systems are in response to linguistic data, providing the obscure interface mass toward MLP. The (trained) neural network can be adapted to get the desired command outputs. Figure 7 show general structure of neural fuzzy system. There are many procedure which care for the combination of FLC with artificial neural network, the Adaptive Neuro-Fuzzy Inference System (ANFIS) is implemented by Jang (1993) and it's functionally equivalent to Sugeno's Inference Mechanism:

$$R_1: \text{if } x \text{ is } A_1 \text{ and } y \text{ is } B_1 \text{ then } z_1 = a_1x + b_1y$$

$$R_2: \text{if } x \text{ is } A_2 \text{ and } y \text{ is } B_2 \text{ then } z_2 = a_2x + b_2y \quad (32)$$

**Feedback linearization control:** The “nonlinear autoregressive moving average” (NARMA) is a model that's applied to current input-output behavior of nonlinear systems. The NARMA model is represents by the equation<sup>[17]</sup>.

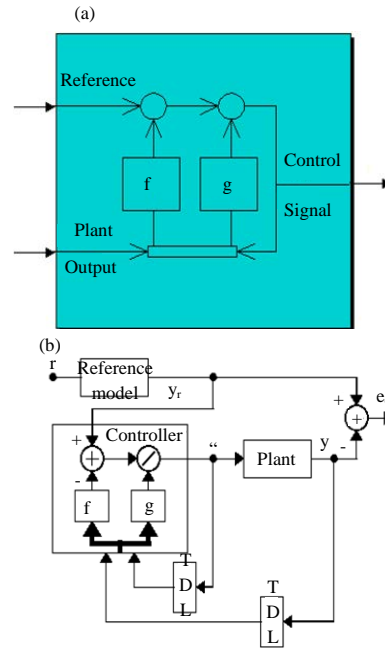

Fig. 8: Block controller of NARMA

$$y(k+d) = Nf[y(k), y(k-1), \dots, y(k-n+1), u(k), u(k-1), \dots, u(k-n+1)] \quad (33)$$

where,  $u(k)$  is an input of the system and  $y(k)$  is output of structure. ANNs are required training to estimate the nonlinear purpose. Nf is the system identification. Figure 8 shows a block controller of (NARMA) with estimated nonlinear purpose (f and g), (TDL) is time shifting, implemented in the NARMA. Controller is a multi-layer feed forward network applied successfully in the identification and control of dynamic systems<sup>[18]</sup> the most important at the rear the NARMA is converting nonlinear structures to linear in dynamic systems.

**Simulation model and results:** Simulation Model of WT Wind turbine modeling presented in previous study via. the mathematical expressions and implementation a simulink model of control for pitch angle in WT using artificial intelligent, now converts these expressions in simulation modeling to calculate all parameters of the WT from energy of wind to generate torque of the WT and controlling it (Fig. 9).

**Simulation of wt without controllers:** At the first step of this work simulate WT without controller to get the output that illustrate in Fig. 10. The unit step response for pitch control without controller is shown in Fig. 11, so, the desired output illustrate is not 1, the overshoot is 18%. The specifications of time domain experimental of response show in Table 3.

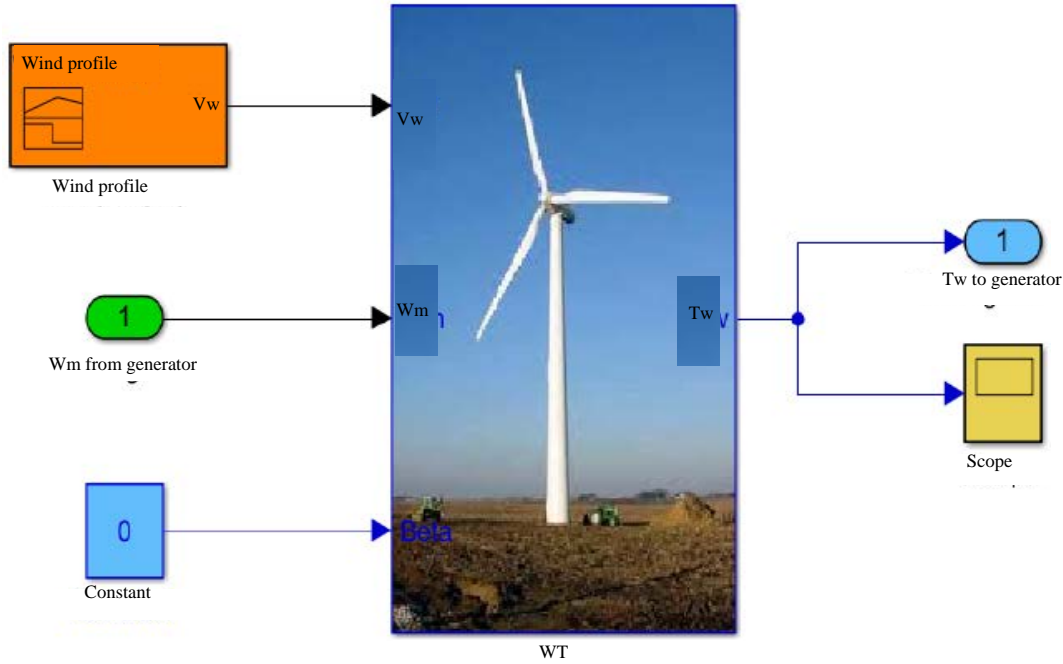

Fig. 9: The WT representation via MATLAB/SIMULINK

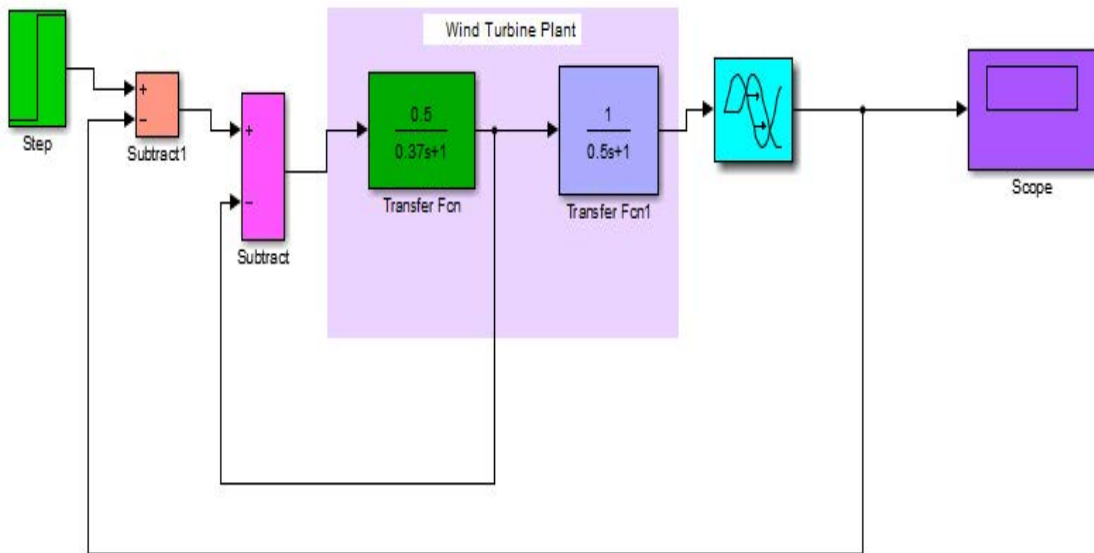

Fig. 10: Simulink wind turbine model without controllers

**Models of WT simulation by artificial intelligent technique**

**Implementation PID controller:** The Simulink model of pitch control with PID Controller shown in Fig. 12 and parameter of PID adjust in Fig. 13. The unit step response of pitch control shown in Fig. 13. The specification time domain experiential of response with PID controller illustrate in Table 4 that present less rise time (5 sec),

settling time (10 sec) and peak overshoot of (0.08 sec) when compared with WT model without controller.

**Implementation NARMA controller:** The simulink model of pitch control with NARMA controller illustrate in Fig. 14. The closed loop of NARMA controller implementation using two stages are control recognition system and design, if system is selected and generated

Table 3: Time domain specification for unit step input without controller

Parameter	pitch angle	Rise time	Settling time	Peak time	Peak value	Overshoot
Without controller		3	15	1	100	18%

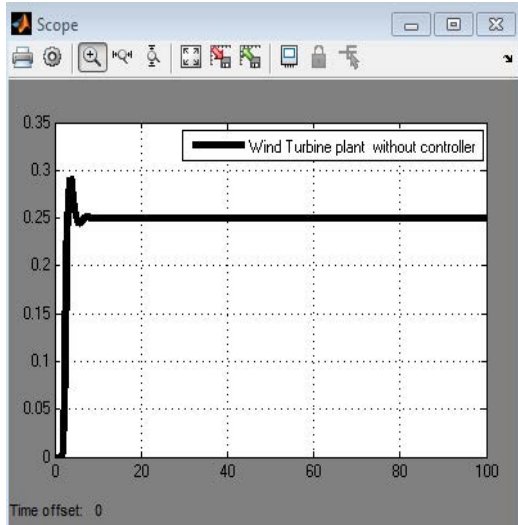

Fig. 11: The unit step response of wind turbine without controllers

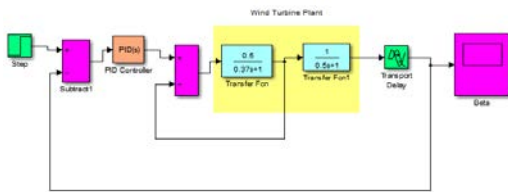

Fig. 12: Simulink wind turbine model with PID controllers

data is show in Fig. 15. Figure 15 illustrate the maximum and minimum value of plant inputs for the pitch angle are 1,0. For minimum plant production, the maximum values are INF and 0. Before training the state neural network, 200 data sets are conducted for the training test. The input and output of pitch angle are generated reflect on the maximum and minimum value for separation at 5 and 1 sec. This data is create by the generate training data option. Data training perform by inputting the simulink model into plant. The size for hidden layer 33 and the number of input and output of the delayed plants is adjusted at 4 and 5, respectively. The preview interval is set to 0.1 sec. The training is conducted in accordance with the selected training function (trainlm). The Figure 16 show step reference input that is use training and response of the closed loop plant the plant response should follow the reference model Figure 17 and 18 show the training” validation of

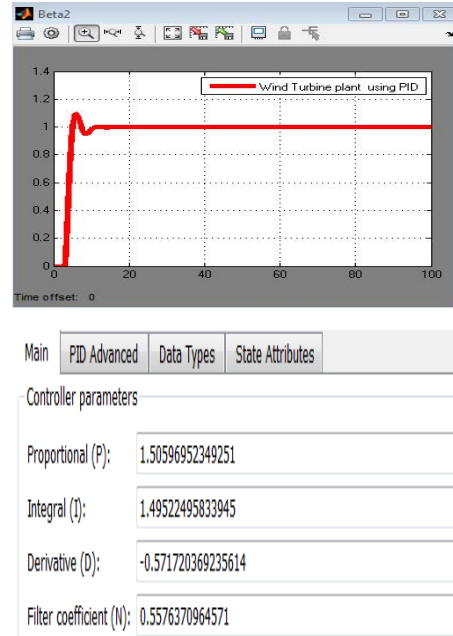

Fig. 13: Control parameters and unit step response of wind turbine for the PID controller

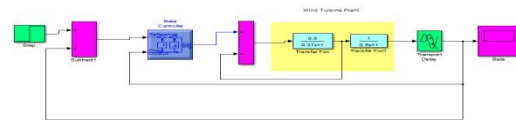

Fig. 14: Simulink Wind Turbine Model with NARMA controllers

data regressions of NARMA controller and performance in NARMA controller. The unit step response of pitch control illustrate in Fig. 19. The specification of time domain from the response show in Table 5 with NARMA controller, that give a rise time (0 sec), settling time 6 sec and peak overshoot of (0 sec) when compared with WT model without controller

**Implementation Adaptive Neru-Fuzzy (ANFIS) Controller:** The simulink model WT of pitch control with ANFIS Controller is illustrate in Fig. 20. The Fig. 21 illustrated Load data set or training from workspace in MATLAB. This set of set will be utilize to train a fuzzy system by attend membership function parameters to give best model from this data. The then step is to indicate initial system of fuzzy inference (NFIS) to train. Training for 100 epochs with zero error .The generate ANFIS



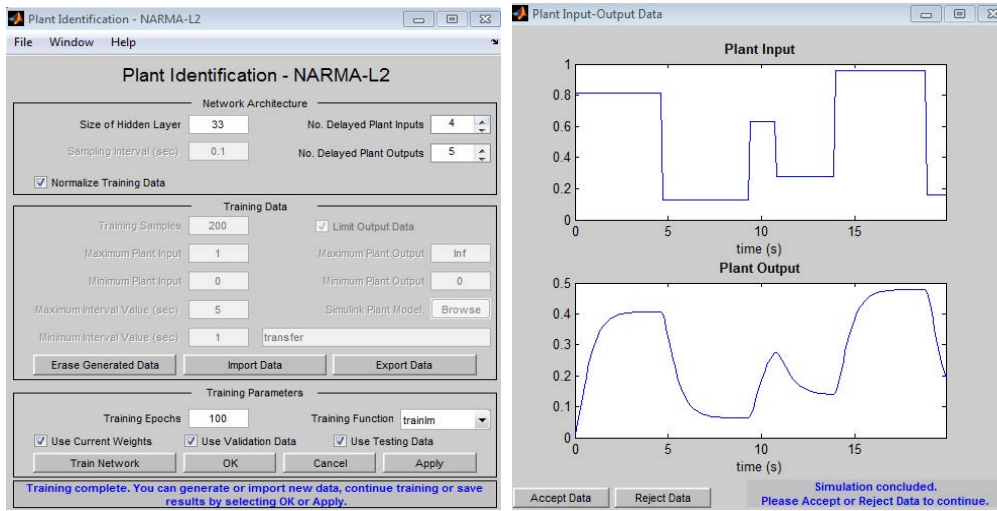

Fig. 15: Identification block and input-output data controller for NARMA

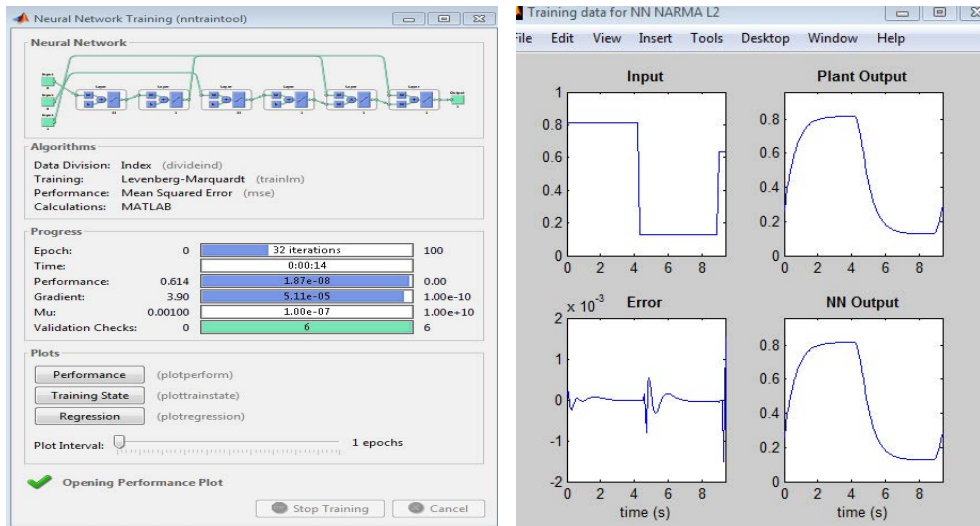

Fig. 16: Training and Training data of ANN of NARMA

Table 4: Time domain specification for unit step input with PID controller

Parameter	pich angle	Rise time	Settling time	Peak time	Peak value	Overshoot
PID		5	10	1.08	100	0.08

Table 5: Time domain specification for unit step input with NARMA controller overshoot

Parameter	pich angle	Rise time	Settling time	Peak time	Peak value	Overshoot
NARMA		0	6	1	100	0

structure contains 9 rules with membership function of input factors. The unit step response of pitch control illustrate in Fig. 22. The specification time domain show in Table 6 with ANFIS controller that give a rise time (0 sec settling time (5.8sec) and overshoot (0 sec).

**Comparison results of WT using PID, ANFIS, NARMA controller** The unit step responses of pitch control apply PID, ANFIS, NARMA Controller are compared that illustrate in Fig. 23. Table 7 and Fig. 24 illustrates that the ANFIS controller it's give a better response while compared with (PID, NARMA)

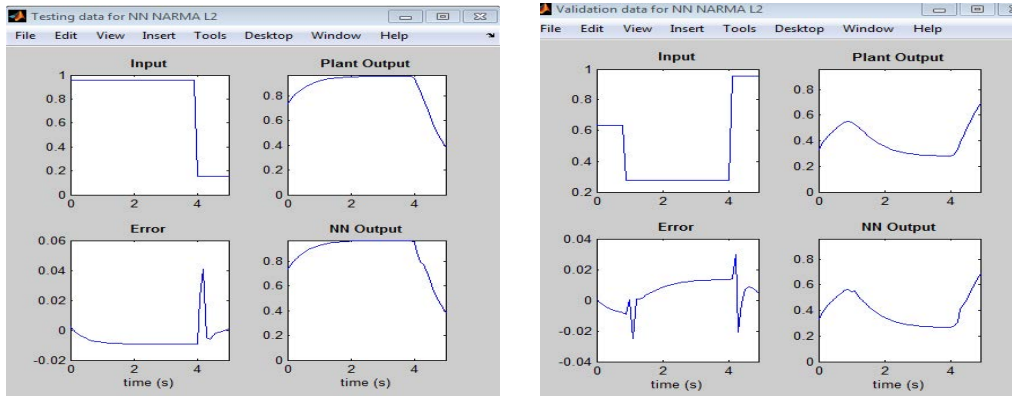

Fig. 17: Training data of pitch angle in NARMA controller and validation data of pitch angle

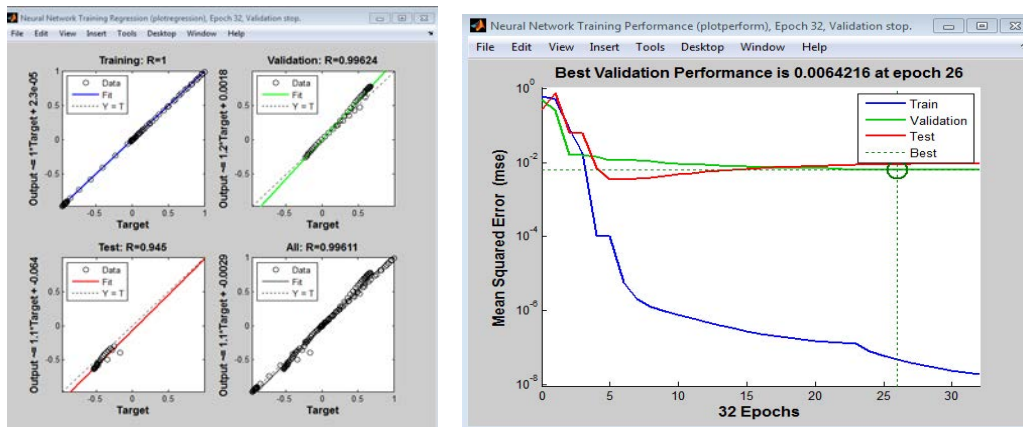

Fig. 18: Regressions of NARMA Controller and Performance in NARMA controller

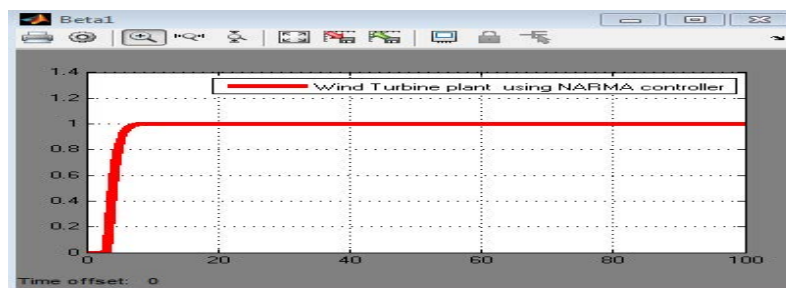

Fig. 19: The unit step response of wind turbine with NARMA controllers

Table 6: Time domain specifications the unit step response with ANFIS controller

Parameter pitch angle	Rise time	Settling time	Peak time	Peak value	Overshoot
ANFIS	0	5.8	1	100	0

Table 7: Comparison time domain specification for unit step input with PID, fuzzy and NARMA controller

Parameter pitch angle	Rise time	Settling time	Peak time	Peak value	Overshoot
NARMA	0	6.0	1.00	100	0.000
ANFIS	0	5.8	1.00	100	0.000
PID	5	10.0	1.08	100	0.08

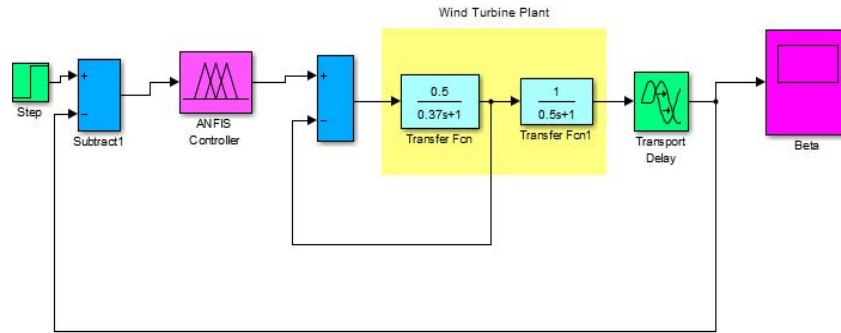

Fig. 20: Simulink wind turbine model with ANFIS controllers

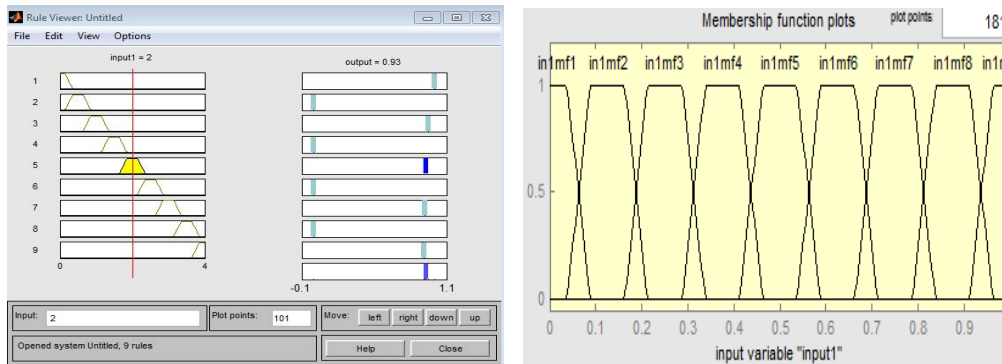

Fig. 21: Rules of FIS in ANFIS controller and membership function of input FIS in ANFIS controller

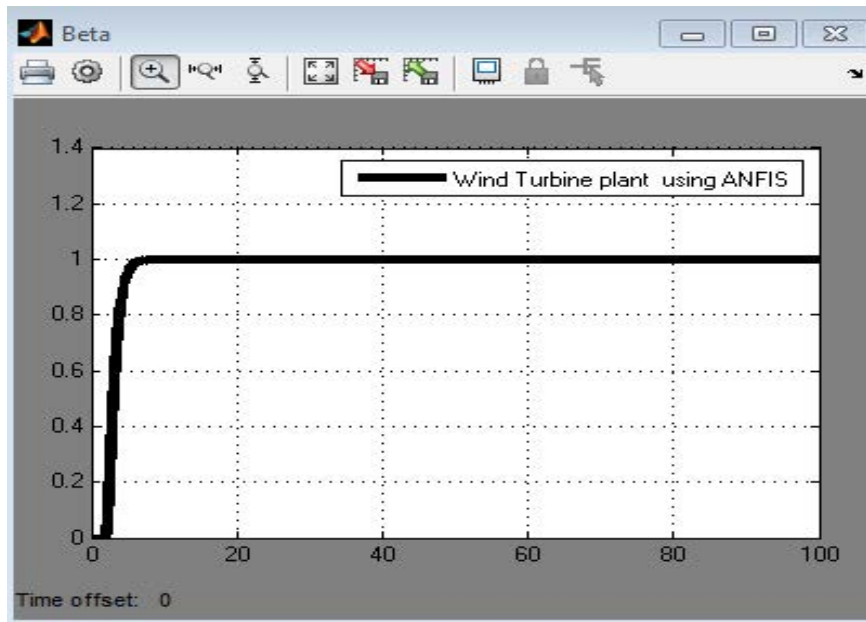

Fig. 22: The unit step response of wind turbine pitch control with ANFIS

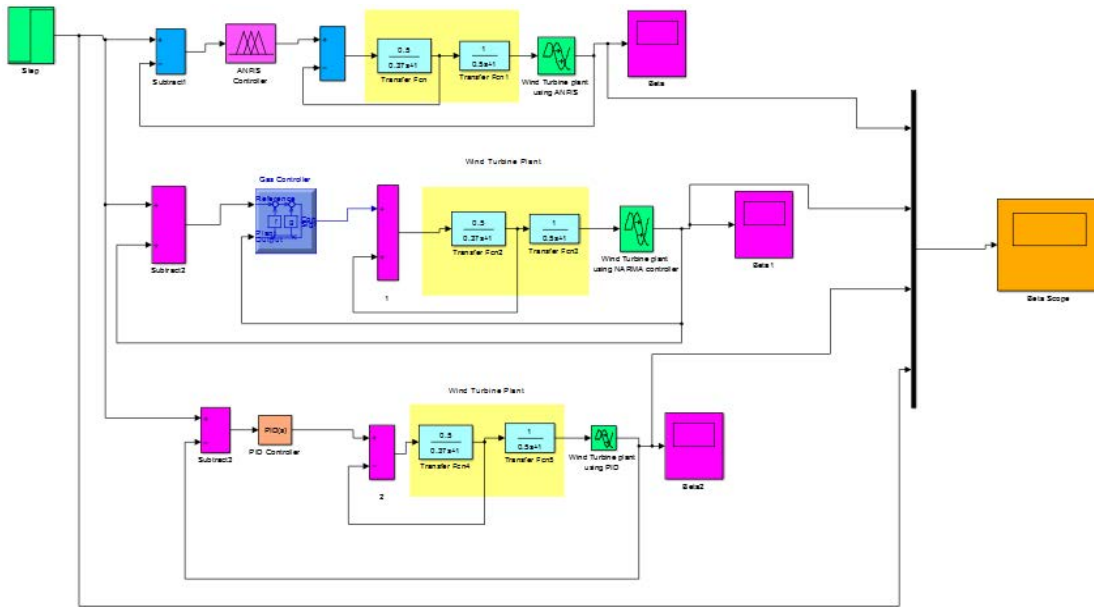

Fig. 23: Comparison of simulation of the wind Turbine using PID, Fuzzy and NARMA Controller

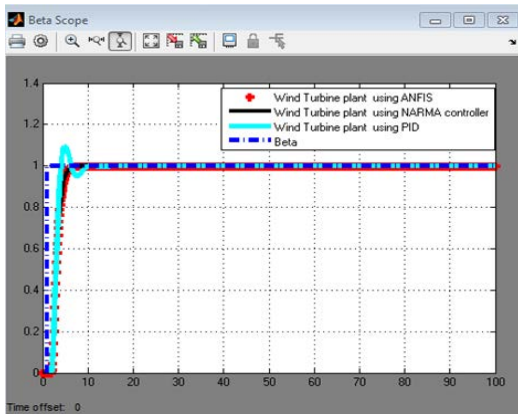

Fig. 24: Compared the response of wind turbine with, PID, ANFIS NARMA ,Controller

controllers as parameters settling time is (0sec) and overshoot is (0 sec). As well as the ANFIS controller is give a best control for pitch angle of WT system.

### CONCLUSION

The results of this study are obtain using simulation model of intelligent technique by Matlab program (V2014a). This paper developed of control pitch angle, simulated mathematical model with PID, ANFIS, NARMA and compared responses in specifications time domain for unit step input applied PID, ANFIS, NARMA controllers. The PID controller give response with peak

overshoot of( 0.08 sec) and with rise time of (5 sec). When applied the NARMA controller the result, gives lesser rise time (0 sec), settling time (6 sec) and peak overshoot of (0 sec). Also the product using ANFIS controller illustrate the error is zero steady state and rising time (0), settling time (5.8 sec) and of best stability. As well the ANFIS controller present comparatively fast response of input unit step. This technique is better to realize of pitch angle control and stability of WT output power. Pitch-parameter system is driven electrically and intelligent technology control utilize in wind power generators increasingly.

### REFERENCES

1. BoroumandJazi, G., R. Saidur, B. Rismanchi and S. Mekhilef, 2012. A review on the relation between the energy and exergy efficiency analysis and the technical characteristic of the renewable energy systems. *Renewable Sustainable Energy Rev.*, 16: 3131-3135.
2. Sarkar, M.R., S. Julai, C.W. Tong, O.Z. Chao and M. Rahman, 2015. Mathematical modelling and simulation of induction generator based wind turbine in MATLAB/SIMULINK. *ARPN. J. Eng. Applied Sci.*, 10: 17276-17280.
3. Yaramasu, V. and B. Wu, 2017. *Model Predictive Control of Wind Energy Conversion Systems*. Wiley and Sons, Hoboken, New Jersey, USA., Pages: 471.

04. Silpa, B., 2017. Pitch control of wind turbine through PID, fuzzy and adaptive fuzzy-PID controllers. M.S. Thesis, Rochester Institute of Technology, Rochester, New York, USA.
05. Qi, Y. and Q. Meng, 2012. The application of fuzzy PID control in pitch wind turbine. *Energy Procedia*, 16: 1635-1641.
06. Civelek, Z., E. Cam, M. Luy and H. Mamur, 2016. Proportional-integral-derivative parameter optimisation of blade pitch controller in wind turbines by a new intelligent genetic algorithm. *IET. Renewable Power Gener.*, 10: 1220-1228.
07. Suganthi, L., S. Iniyar and A.A. Samuel, 2015. Applications of fuzzy logic in renewable energy systems-a review. *Renewable Sustainable Energy Rev.*, 48: 585-607.
08. Costa, P.J., A.S. Carvalho and A.J. Martins, 2010. Fuzzy Logic as a Method to Optimize Wind Systems Interconnected with the Grid. In: *Wind Power Systems*, Wang, L., C. Singh and A. Kusiak (Eds.). Springer, Berlin, Germany, pp: 383-405.
09. Sanchez, E.N. and R. Ruiz-Cruz, 2016. *Doubly Fed Induction Generators: Control for Wind Energy*. CRC Press, CRC Press, New York, USA., Pages: 148.
10. Abad, G., J. Lopez, M. Rodriguez, L. Marroyo and G. Iwanski, 2011. *Doubly Fed Induction Machine: Modeling and Control for Wind Energy Generation*. Vol. 85, John Wiley & Sons, New York, USA.,
11. Fortmann, J., 2014. *Modeling of Wind Turbines with Doubly Fed Generator System*. Springer, Wiesbaden, Germany,.
12. Alhazmi, M.M., 2015. *Modeling of doubly-fed induction generator using matlab/simulink*. Ph.D. Thesis, California State University, Los Angeles, California.
13. Yin, X.X., Y.G. Lin, W. Li, Y.J. Gu, X.J. Wang and P.F. Lei, 2015. Design, modeling and implementation of a novel pitch angle control system for wind turbine. *Renewable Energy*, 81: 599-608.
14. Novak, P., T. Ekelund, I. Jovik and B. Schmidtbauer, 2002. Modeling and control of variable-speed wind-turbine drive-system dynamics. *IEEE. Control Syst. Mag.*, 15: 28-38.
15. Burns, R.S., 2001. *Advance Control Engineering*. Butterworth-Heinemann, Oxford, UK., Pages: 433.
16. Math Works, 2014. *Fuzzy logic toolbox user's guide*. Technical Report, The MathWorks Inc., Natick, Massachusetts.
17. Narendra, K.S. and S. Mukhopadhyay, 1997. Adaptive control using neural network and approximation model. *IEEE Trans. Neural Networks*, 8: 475-485.
18. Beale, M.H., M.T. Hagan and H.B. Demuth, 2011. *Neural network toolbox user's guide*. The MathWorks Inc., Natick, Massachusetts.