

## Utility GTO Toll Gate Pasteur Bandung Using Simulation Model

Agus Riyanto and Ifaz Fazlurahman

Department of Industrial Engineering, Indonesian Computer University, Bandung, Indonesia

**Abstract:** High volume of traffic at the toll gate pasteur is the main cause of the queues at the substation out, with the issue PT. Jasamarga provide GTO (Gerbang Tol Otomatis) substation built to serve transactions using e-toll card and speed up transactions at the substation out so it can reduce the queues that occur at the toll gate pasteur. To find significant use of GTO substations can reduce the queues that occur in substations exit at the toll gate cluster 1, the purpose of this study is to performance analysis to determine the level of performance of the substation GTO system and the actual maximum capacity of the volume of traffic that can be served by the use of GTO booth at the toll gate pasteur. The study began by collecting the data necessary to create simulation models, data has been collected and processed using software StatFit to determine the pattern of distribution of the data, once complete data is continued with the development of simulation models using Promodel 2014 student version. The output of the simulation model created later validated by testing t-test using SPSS software. Once the models are made valid, then the research continued with experimentation models to obtain data in accordance with the purpose of research. Data from these experiments is then analyzed to obtain a final conclusion. Performance analysis of simulation output results showed the highest utility substations GTO of 23.30% with 4.46 seconds service time at the toll gate pasteur Analysis for maximum capacity of substations GTO at toll gate pasteur can serve 102,500 vehicles a day at 8 substations operating GTO.

**Key words:** GTO, utility, simulation model, toll gate pasture, toll gate cluster

---

### INTRODUCTION

Highways to modern society become a necessity in providing easy access for travel from origin to destination. This issue is of particular concern for designers and developers of the highway in building toll roads with high quality. Construction of toll roads is not spared by the toll gate design good that will significantly impact on the effectiveness to parse the queue of vehicles that will make transactions at substations out. In this case it is the toll gate pasteur to enter the city of Bandung connected with Cipularang.

PT. Jasamarga presents substation automatic toll for using GTO highway users make transactions just by using the card which particular GTO without having to provide the correct change or wait for change, so that transactions that take place on a substation out only takes approximately 4 seconds. With time to dis efficiency is expected to parse the queue happens to the toll gate pasteur.

PT. Jasamarga currently provides only one substation GTO to operate, due to the volume of traffic continues to grow then PT. Jasamarga should conduct an analysis of performance against the use of GTO

substation that exist today are significantly reduced queues that occur in substations exit at the toll gate pasteur.

Performance analysis conducted on the use of GTO substation to improve service quality by reducing queues that occur can be analyzed using three approaches, queuing theory, experiments and models directly simulation model approach to analyze the performance of substations GTO on toll gate pasteur is expected to be used as a basis in the decision made by PT. Jasamarga. The research aims to design a simulation model queue of substations GTO on toll gate pasteur as a performance analysis tool with the following specific objectives:

- Identify the performance level of the substation GTO exit at the toll gate pasteur
- Identify the maximum traffic volume that can be served at the toll gate pasteur with a GTO operating
- Designing a configuration scenarios use 2-8 substations GTO (GTO) at the toll gate pasteur

This research was conducted with the assumptions used are:

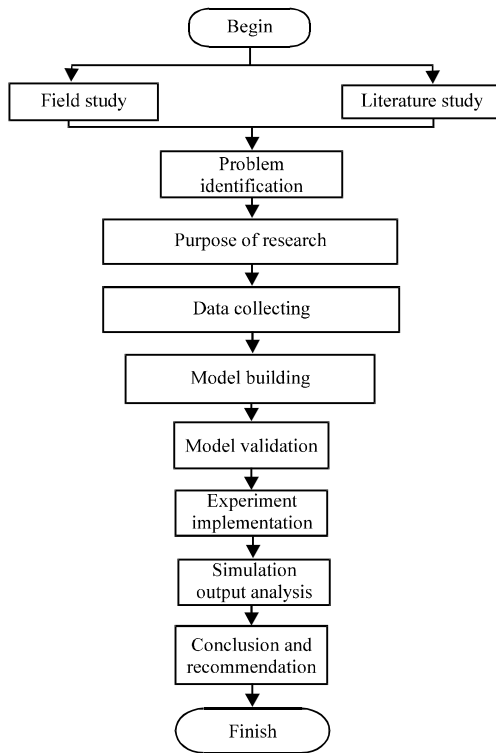

Fig. 1: Flowchart research

- Vehicles not change lanes when it entered the queue who have been queuing lane
- Operators in counters work in optimal conditions
- The engine in the GTO work in optimal conditions.
- Speed is considered the same car when it entered the queue lane
- Vehicles are assumed to have the GTO card and has sufficient funds for the transaction at the time of entering the path of the GTO

**Literature review:** The queue is a waiting line of customers (unit) which requires the services of one or more maids (care facilities) (Intan, 2016; Zhang and Chung, 2016; Kuo and Chen, 2015; Krisnawati *et al.*, 2016) process the queue (queuing process) is a process associated with the arrival of a person at a customer service facility, then wait in a line (queue) if all the servants busy and eventually left the facility. A queuing system is a set of customers, waiters and a rule that governs the arrival of the customer and the processing problem.

Simulation is defined by Harrel (2004) as “an imitation of a dynamic system that is made using computer models with the aim to evaluate and improve performance of the system”. The system, in this case according to Harrel (2004) is “a set of elements that work together to achieve the desired objectives”.

After discussing the simulation comes to know the classification of simulation as well as making steps in the simulation, then the next step will be to discuss the understanding of the system which, according to Blanchard, quoted by Harrel (2004) system as used herein, is defined as: “A collection of elements that function together to achieve a desired goal”. Set of elements is a combination of components and elements together to achieve certain goals.

Promodel is one program design simulation model, a good simulation of discrete systems and continuous system. The process of designing the Promodel simulation model involves the use of elements of basic and advanced elements. Basic elements include locations, entities, path networks, resources, processing, arrivals, background graphics and general information, while advanced elements include attributes, variables, arrays, macros, subroutine, cycle arrival and user distributions.

### Description of research

**Procedure research:** Research conducted at the toll gate pasteur in PT. Jasa Marga. Figure 1 explaining the procedures for implementing the study. Making use of software Promodel simulation model 2014 with the procedure described in Fig. 2.

**Data collection and analysis system:** Structural data is data involving the object to be modeled in the simulation. In the design of the toll gate simulation model pasteur, the structural data that is needed is the data regarding the entities involved in the toll gate system and data locations involved in the system in accordance with the scope of the model to be created. Data entities and locations is required as input in the manufacturing simulation model.

Location data is also used as a reference for the manufacture of the layout of the simulation model is built. Operational data is the way the system operates. Operational data required in the design of the toll gate simulation model pasteur is data about the flow of the entities in the system and toll gate pasteur. Data flow entities required as input to set the process flow simulation model.

Numerical data required in building a simulation model is historical traffic data rates and data service time tollbooth. Data traffic levels are required as input levels of traffic and data service time required as input to the process time simulation model. Data requirement that was previously set will be met through multiple data sources, namely:

- Recap operational data PT. Jasamarga
- Direct observations to the toll pasteur
- Interview with the PT. Jasamarga, in this case the head of shift at the toll gate pasteur

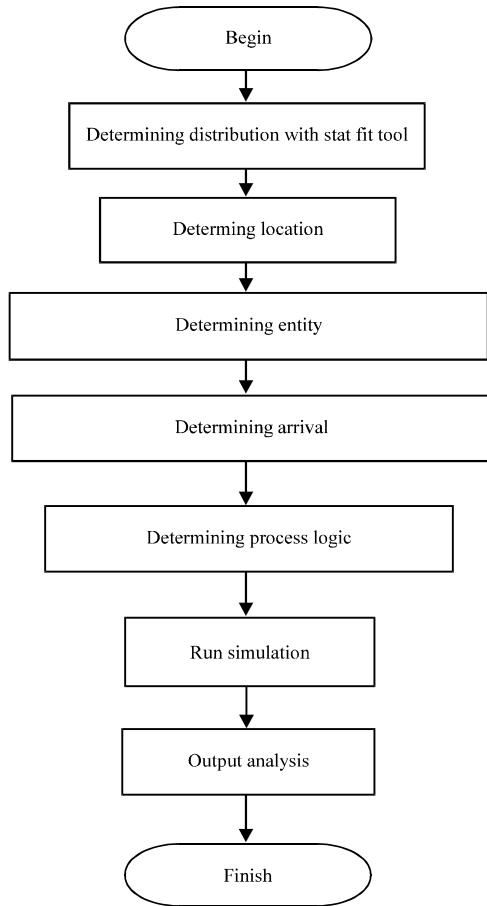

Fig. 2: Flowchart promodel

**Entity flow diagram pasteur toll gate**

**Data analysis system:** Layout is a layout of each location on the system. Layout of data obtained through direct observation at toll gates pasteur. Layout is made to function as a background simulation model. The results of the manufacturing layout is shown in Fig. 3 and 4.

Statistical analysis was performed with the aim to analyze the raw data that deserve to be input to the model. Statistical analyzes include testing of data independence, homogeneity of data and establishment of data distribution. The data analyzed are numerical data that is data of car traffic and the time of payment processing. In this study, statistical analysis was performed using software assistance stat: Fit and Data Analysis Toolpak Ms. Excel. Analysis of Data Traffic Car on Pasteur Toll Gate.

**Test of independence:** In the second test data, the median test results of tests on the result to produce a decision do not reject, indicates acceptance of the hypothesis that

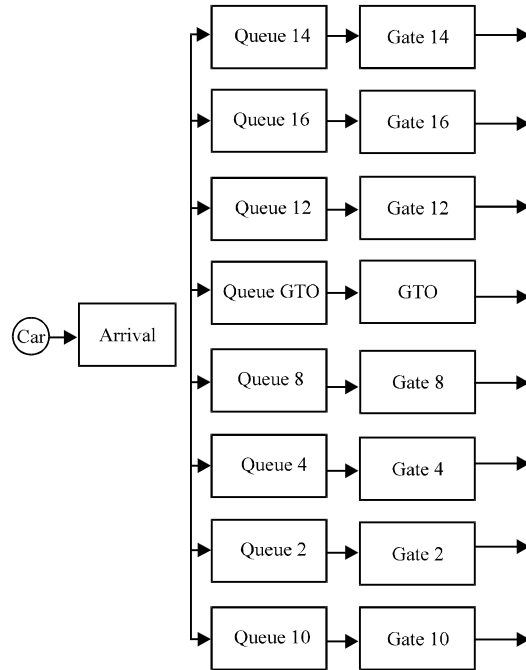

Fig. 3: EFD Pasteur toll queue system; (the results of direct observation)

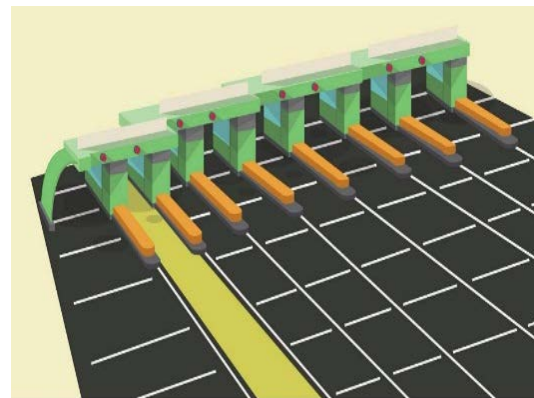

Fig. 4: Layout pasteur tol gate model

the data is random. Based on the test results, we can conclude that the data traffic in March and April 2016 are random so as to meet the assumptions of homogeneity testing (Fig. 5).

**Homogeneity test:** Based on these results the results obtained  $F < F_{critical}$ , indicating that the second data is no difference average value is significant. It can be concluded that the data of car traffic in March and April 2016 are from the same population and have identical distribution.

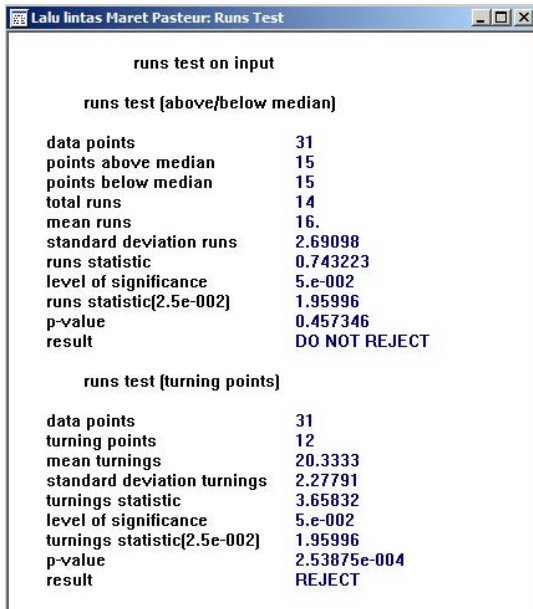

Fig. 5: Run test

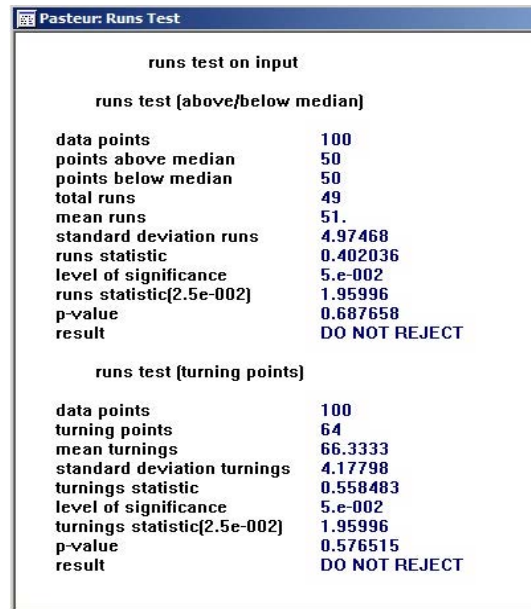

Fig. 7: Run test regular time pasteur

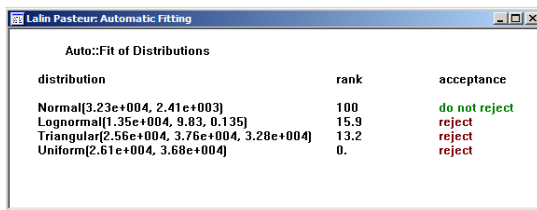

Fig. 6: Distribution stat: Fit

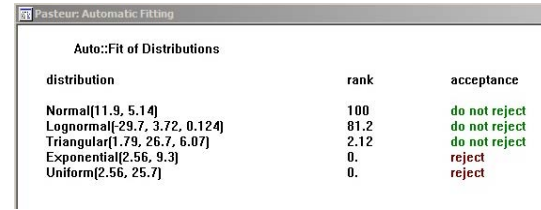

Fig. 8: Auto fit dtistribution

**Determination of distribution:** The process of setting the distribution is done with the help of software stat: fit using auto functions: fit. Results auto: fit the data traffic in March and April combined 2016. Distribusi in accordance with the data pattern is normal (32300, 2410) looks at the decision do not reject on the distribution. The rank on these results contained in normal distribution (32300, 2410) (Fig. 6).

**Payment process time data analysis pasteur toll gate regular payment processing time**

**Test of independence:** Based on the test results, researchers can conclude that the data of a random time of the payment process so that it meets the assumptions for the determination of the distribution (Fig. 7).

**Determination of distribution:** The rank on these results contained in normal distribution (11.9, 5:14) so that, the theoretical distribution was chosen for daily traffic is normal distribution (11.9, 5:14) (Fig. 8).

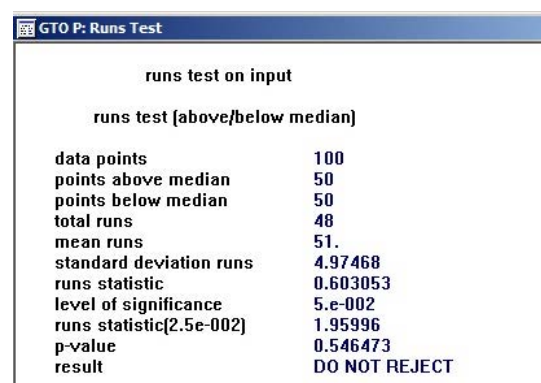

Fig. 9: Run test GTO time pasteur

**Time payment process GTO**

**Test of independence:** Based on the test results, we can conclude that the data of a random time of the payment process, so that, it meets the assumptions for the determination of the distribution (Fig. 9).

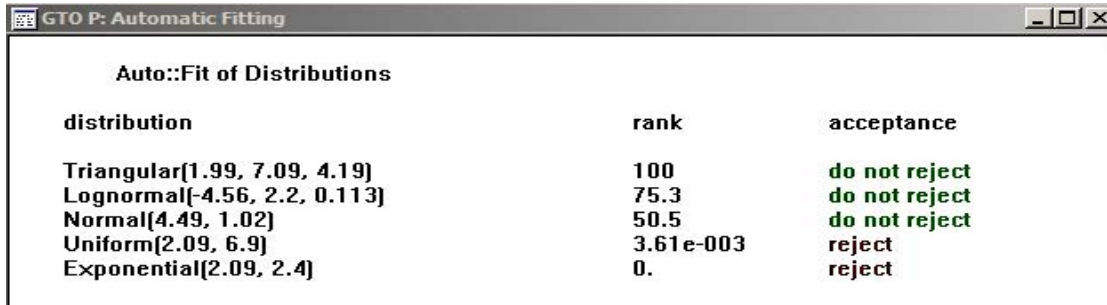

Fig. 10: Auto fit dfdistribution



Fig. 11: Input pasteur model location

**Determination of distribution:** The rank on these results contained in triangular distribution (1.99, 7:09, 4:19) so that the theoretical distribution was chosen for daily traffic is distribution triangular (1.99, 7:09, 4:19) (Fig. 10). Data in Table 1 will be used as input data for the coming cycle of the entity in the simulation model to be built.

**Development model:**

- Model pasteur
- Locations

Location data structural system includes a place of arrival, the queues, and the substation toll payments. Location data created on promodel can be seen in (Fig. 11).

**Entity:** In the simulation model the toll gate pasteur, the entity represented by the entities car is a car. Determination entities on promodel is shown in Fig. 12.

Table 1: The average percentage of arrivals per hour entities at the Pasteur toll gate

Clock time	Average (%)
5:00:00-5:59:00	1.83
6:00:00-6:59:00	5.96
7:00:00-7:59:00	6.49
8:00:00-8:59:00	6.27
9:00:00-9:59:00	6.19
10:00:00-10:59:00	6.19
11:00:00-11:59:00	6.06
12:00:00-12:59:00	5.80
13:00:00-13:59:00	5.70
14:00:00-14:59:00	5.74
15:00:00-15:59:00	5.73
16:00:00-16:59:00	5.83
17:00:00-17:59:00	5.47
18:00:00-18:59:00	5.36
19:00:00-19:59:00	4.81
20:00:00-20:59:00	3.85
21:00:00-21:59:00	3.18
22:00:00-22:59:00	2.67
23:00:00-23:59:00	2.09
0:00:00-0:59:00	1.51
1:00:00-1:59:00	1.05
2:00:00-2:59:00	0.75
3:00:00-3:59:00	0.66
4:00:00-4:59:00	0.82
Total	100.00

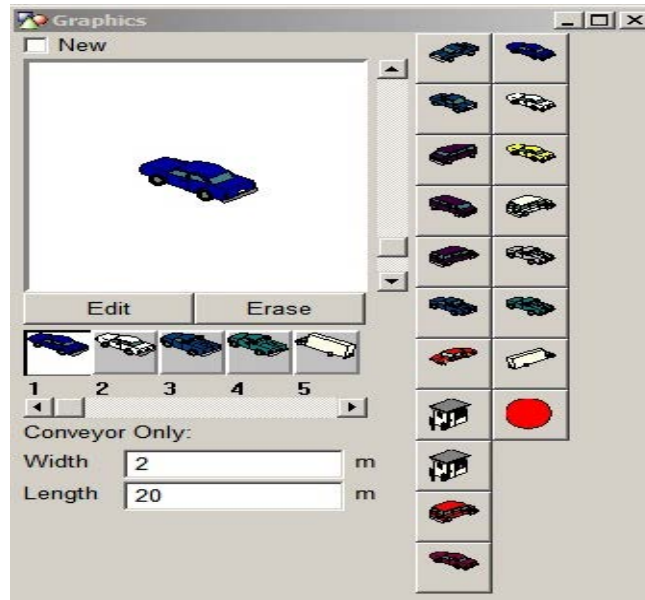

Fig. 12: Entity model pasteur

Entity...	Location...	Operation...
Mobil	Kedatangan	Jenismobil = Rand(6)Graphic Jenismo
Mobil	Jalur16	Waktu_masuk_antrian = Clock(min)Inc
Mobil	Jalur14	Waktu_masuk_antrian = Clock(min)Inc
Mobil	Jalur12	Waktu_masuk_antrian = Clock(min)Inc
Mobil	Jalur10	Waktu_masuk_antrian = Clock(min)Inc
Mobil	Jalur8	Waktu_masuk_antrian = Clock(min)Inc
Mobil	Jalur4	Waktu_masuk_antrian = Clock(min)Inc
Mobil	Jalur2	Waktu_masuk_antrian = Clock(min)Inc
Mobil	Jalur18	Waktu_masuk_antrian = Clock(min)Inc
Mobil	Gardu14	Wait Waktu_Pelayanan_Reguler sec
Mobil	Gardu16	Wait Waktu_Pelayanan_Reguler sec
Mobil	GTO	Wait Waktu_Pelayanan_Reguler sec
Mobil	Gardu8	Wait Waktu_Pelayanan_Reguler sec
Mobil	Gardu4	Wait Waktu_Transaksi_GTO sec
Mobil	Gardu2	Wait Waktu_Pelayanan_Reguler sec
Mobil	Gardu18	Wait Waktu_Pelayanan_Reguler sec
Mobil	Gardu12	Wait Waktu_Pelayanan_Reguler sec

Fig. 13: Processing model pasteur

**Processing:** Processing entities shows how the procedure from the beginning to the end of the simulation process. In the simulation model, there are 17 processes and 17 routing algorithms that provide how the simulation is run. Each process is explained by operating activities to be performed by the simulation model. Below is a breakdown of the 17 processes and routing of the simulation model created. The entire process can be seen in Fig. 13.

**Simulation model validation pasteur:** Model validation was performed using the compare means testing Independent Sample Testing test was conducted using SPSS with the criteria for rejection of  $H_0$  when the probability value (Sig.)  $< 0.05$ . Data being tested is running the model with data from a 24 h run time by 30 replication. The test is then performed using SPSS using independent-sample t-test with a significance level of 5 and 95% confidence level.

The test results are the results of testing independent output sample test. Significance value (Sig. (2-tailed)) indicates a value above 0.05 which shows that  $H_0$  is accepted in the entire test, which means it is both the average population are identical or no difference in the average population between the results Output ProModel with actual data, with the test can be proved that the simulation models are made are valid.

**MATERIALS AND METHODS**

**Identification day toll gate level performance**

**Level of performance daily pasteur toll gate:** The level of performance that is measured is the rate per utility substations, utility rates per hour, average queue time, the average time of service and maximum queue length. To get the data rate performance of the actual system that occurred at the toll gate pasteur, the simulation model is run 13 times replication to obtain an average arrival of the car approximately 1,000 vehicles per hour. Simulation output of each replication for substasion utility rates are shown in Table 1.

Utility rates taken from the hourly average utility of the model simulations run as much as 13 replication. For the data shown is obtained from two shifts, is shift 1 at 05:00 till 12:59 h and the second shift at 13:00 h till 20:59 h.

**Identification of maximum volume traffic can be served from 1 GTO operative at toll gate pasteur:** Scenario maximum traffic volume pasteur toll gate to get maximum traffic volume that can be served by the current system of toll gate pasteur made experiments as much as 15 scenarios.

**Using configuration scenarios 2-8 substation GTO at toll gate pasteur:** Use of substation configuration GTO on toll gate pasteur scenarios on the configuration of the GTO substations do to get maximum traffic volume of data that can be served when the substation GTO applied to more than one at the substation exit at the toll gate pasteur. The scenarios are run as many as 15 scenarios with arrivals increased by 1500 vehicles.

**RESULTS AND DISCUSSION**

**Daily performance level analysis of toll gate:** Daily performance level analysis of toll gate pasteur based on the results of experiments conducted in the previous chapter that the data obtained can be analyzed for the purpose of research in the design simulation model that has been predetermined. The analysis of this performance level of the data obtained daily utility substations, substation utility data per hour, the queuing time at each substation, service time for each substation and the maximum queue length is happening at each substation at the toll gate pasteur (Table 2).

Table 2: Table level performance daily pasteur toll gate

Gates	Utility (%)	Service average		Queue average time (sec)
		time (sec)	Max. queue	
14	47.77	11.88	19	58.08
12	48.74	11.91	22	56.83
10	56.62	11.92	24	77.19
8	56.62	11.80	34	257.82
6	66.03	11.89	35	314.62
2	61.47	11.97	35	282.47
16	39.60	11.90	13	39.24
GTO	23.30	4.46	11	30.33

Table 3: Configuring the substations use GTO

GTO	Capacity	Queue		
		time average	Max. queue	Average utility
2	40500	1.37	35	18.28
3	64000	2.01	35	34.98
4	72000	1.76	35	34.10
5	80500	1.76	35	36.89
6	88500	1.53	35	36.05
7	98500	1.94	35	46.22
8	107000	1.75	35	46.70

The level of utility substations and service time per day, the maximum queue length and queue time substation with average arrival obtained from the average of replication as much as 31 900 vehicles with the kind of service 7 sentry regular and 1 substation GTO is as follows: from the results of experiments conducted in previous chapters acquired utility rate data that showed hourly peak hours at the toll gate pasteur is at 07:00 till 07:59 with the number of arrivals as many as 2028 vehicles per hour and maximum utility rates occur at regular substations in the amount of 94.92% and for GTO utility substations maximum of 36.62% at that hour.

**Maximum traffic volume analysis can be served from 1 GTO operative at toll gate pasteur:** Maximum traffic volume analysis pasteur toll gate from the results of the scenario that has been done in previous chapters to get the data volume maximum traffic per day which can be served by the toll gate pasteur with the kind of service 7 substations regular and 1 substation GTO obtained the results as much as 33000 vehicles with the length of the queue maximum of 35 vehicles and the queuing time for 72 sec.

**Usage scenario analysis configuration 2-8 substation GTO at toll gate pasteur**

**Substation configuration analysis using GTO on toll gate pasteur:** The analysis conducted on the results of scenario configuration of substations GTO is to be able to predict the amount of traffic volume maximum that can be served when the addition of more than one substation GTO until the use of substations GTO on the entire substation exit at the toll gate pasteur, data from this analysis can be used as a reference for decision making in the future as for the output configuration of GTO substations to predict the maximum traffic volume can be seen in Table 3.

## CONCLUSION

**Daily toll gate performance pasteur:** The conclusion that can be drawn from the results of the analysis at the toll gate pasteur for daily performance is the maximum queue length, average time of service, the average time queuing, utility substations and utility substations per hour on average per day. The performance measure substation configuration with regular service 7 substations and the type of GTO service 1 substation in accordance with the actual system. At the toll gate pasteur:

- The arrival of 31 900 vehicles per day
- The highest utility substations regular stands at 66.03% with a time of 11.89 sec service
- GTO utility substations highest stands at 23.30% with service time 4.46 sec
- The maximum queue length for a total of 35 regular substation vehicle with a time of 314.62 sec queue
- The maximum queue length at substations GTO as many as 11 vehicles with the queuing time for 30.33 sec
- Rush hour took place at 07:00 to 07:59 with the arrival of 2028 vehicles per hour, on the hour utility substations regular stands at 94.92% and the substation GTO stands at 36.62%

**Conclusion maximum volume traffic can be served by the GTO operative at toll gate pasteur:** Conclusions from the analysis in the previous chapter for the maximum traffic volume with the actual system configuration substation, with seven regular substations and one substation GTO: 33000 vehicles per day to the toll gate pasteur with a maximum queue length and as many as 35 vehicles queuing time for 72 sec.

**Conclusions from 2-8 substation configuration using GTO at toll gate pasteur:** In the study by data obtained maximum capacity of the toll gate with 8 substations regular operating of 41000 vehicles per day with the use of substations GTO for the substation exit at the toll gate pasteur to significantly increase the capacity of vehicles that can be served, this is due to the using GTO booth transaction time when entering the substation out approximately only 4 sec. The conclusion that can be drawn from the use of 8 substations GTO is as follows: at the toll gate pasteur with substation configuration out using automated tollbooth 8 (substation GTO) vehicles that can be served per day exceeded 107,000 vehicles per day.

## SUGGESTIONS

Advice can be given based on the conclusions that have been drawn are as follows: from the data the actual system performance seen if the utility substation GTO lower than regular substation during rush hour is caused by the e-toll card users is still small. To enhance the utility of GTO booth on the current system is necessary to increase the e-toll card for the toll road toll gate in cluster 1 in a way to popularize the use of e-toll card as an excuse facilitate and expedite the transaction at substations out.

Configuring the use of more than one substation GTO in increasing the capacity of the traffic volume of vehicles that can be served at the toll gate of the cluster must be accompanied by an increase in the number of users of e-toll card for each vehicle entering the highway. For solutions in the future in order to reduce queues and improve the capacity of the volume of vehicles, government and PT. Jasamarga parties must cooperate in issuing a policy for any vehicles entering the motorway must be accompanied proprietary e-toll card, because if the use of the GTO substation the whole substation exit at the toll gate cluster 1, the toll road users who do not have e-toll cards will no longer be able to perform payment transactions.

## REFERENCES

- Harrel, C.R., 2004. Simulation Using ProModel. 2nd Edn., McGraw-Hill, New York, USA.,.
- Intan, W.S., 2016. The analysis factors of experiential marketing, product quality and customer satisfaction of motor bike as a main transportation mode in bandung-Indonesia. *Int. J. Bus. Administrative Stud.*, 2: 6-8.
- Krisnawati, N., L.K. Perangin-angin, M. Zainal and I. Suardi, 2016. Brand equity analysis and its impact on the loyal customer of local batik to develop its competitiveness (An empirical study of Batik Banten in South Tangerang). *J. Admin. Bus. Stud.*, 2: 189-207.
- Kuo, M.P. and Y.M. Chen, 2015. A study on the relationships among body sensory experience, customer satisfaction and customer loyalty-Beauty SPA center as an example. *Intl. J. Bus. Administrative Stud.*, 1: 61-67.
- Zhang, Y. and H. Chung, 2016. Strategizing the customer relationship in the independent bookstore network: A case of small small bookshop in Taiwan. *Intl. J. Bus. Admin. Stud.*, 2: 143-150.